

# Model ZRH

Infrared Analyzer

## Instruction Manual

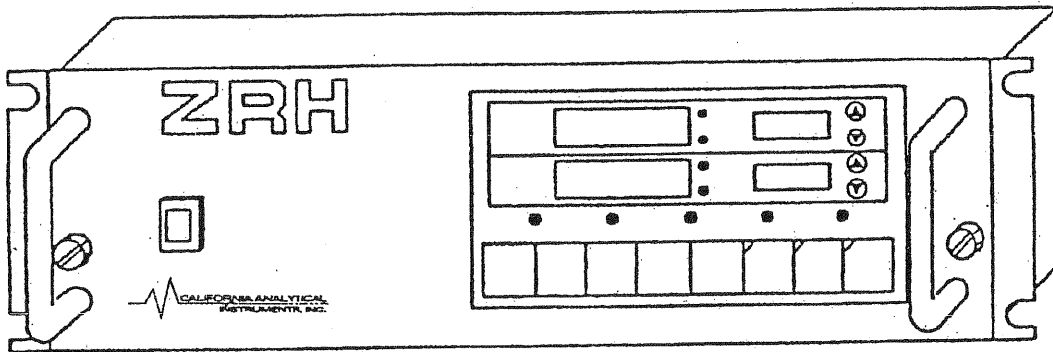

California Analytical Instruments, Inc.  
1238 West Grove Avenue  
Orange, California 92665

(714) 974-5560 Phone  
(714) 921-2531 Fax



CALIFORNIA ANALYTICAL  
INSTRUMENTS, INC.

**WARRANTY CERTIFICATE**

Subject to the exceptions and upon the conditions stated below. California Analytical Instruments (CAI) warrants that the products sold under this sales order shall be free from defects in workmanship and materials for one year after delivery of the product to the original Buyer by CAI and if any such product should prove to be defective within such one year period, CAI agrees, at its option, either (i) to correct by repair or, at CAI's election, by replacement with equivalent product any such defective product, provided that investigation and factory inspection discloses that such defect developed under normal and proper uses, or (ii) to refund the purchase price. The exceptions and conditions mentioned above are as follows:

(a) components or accessories manufactured by CAI which by their nature are not intended to and will not function for one year are warranted only to give reasonable service for a reasonable time; which constitutes reasonable time and reasonable services shall be determined solely by CAI. A complete list of such components and accessories is maintained at the factory;

(b) CAI makes no warranty with respect to components or accessories not manufactured by it; in the event of defect in any such component or accessory. CAI will give reasonable assistance to Buyer in obtaining from the respective manufacturer whatever adjustment is authorized by the manufacturer's warranty;

(c) any product claimed to be defective must be returned to the factory transportation charges prepaid and CAI will return the repaired or replaced product freight collect;

(d) if the product claimed to be defective requires on-site repair, such warranty labor will be provided at no charge, however, transportation and living expenses will be charged to Buyer;

(e) if the product is a consumable or the like, it is warranted only to conform to the quantity and content and for the period (but not in excess of one year) stated on label at the time of delivery or 90 days;

(f) CAI may from time to time provide a special printed warranty with respect to a certain product, and where applicable, such warranty shall be deemed incorporated herein by reference;

(g) CAI shall be released from all obligations under all warranties, either expressed or implied, if any product covered hereby is repaired or modified by persons other than its own authorized service personnel unless such repair by others is made with the written consent of CAI.

IT IS EXPRESSLY AGREED THAT THE ABOVE WARRANTY SHALL BE IN LIEU OF ALL WARRANTIES OF FITNESS AND OF THE WARRANTY OF MERCHANTABILITY AND THAT CAI SHALL HAVE NO LIABILITY FOR SPECIAL OR CONSEQUENTIAL DAMAGES OF ANY KIND OR FROM ANY CAUSE WHATSOEVER ARISING OUT OF THE MANUFACTURE USE, SALE, HANDLING, REPAIR, MAINTENANCE OR REPLACEMENT OF ANY OF THE PRODUCTS SOLD UNDER THIS SALES ORDER. SOME STATES DO NOT ALLOW THE EXCLUSION OR LIMITATION OF INCIDENTAL OR CONSEQUENTIAL DAMAGES, SO THAT THE ABOVE LIMITATIONS OR EXCLUSIONS MAY NOT APPLY. THIS WARRANTY GIVES YOU SPECIFIC LEGAL RIGHTS, AND YOU MAY ALSO HAVE OTHER RIGHTS WHICH VARY FROM STATE TO STATE.

Representations and warranties made by any person, including dealers and representatives of CAI which are inconsistent or in conflict with the terms of this warranty, shall not be binding upon CAI unless reduced to writing and approved by an expressly authorized officer of CAI.

## **RECOMMENDED SPARE PARTS**

### **Models 3300, 3400 & ZRH Infrared Gas Analyzers**

<b><u>Part Number</u></b>	<b><u>Qty</u></b>	<b><u>Description</u></b>
ZZPZFU3-A220	1	Fuse (5/Pkg)
ZZPZFU3-C050	1	IR Source Unit & Chopper

**For Analyzers Ranged:** CO 0-200, 0-500, 0-1000, 0-2000, 0-5000 ppm, or  
CO<sub>2</sub> 0-400, 0-1000 ppm

ZZPZFU3-C310	2	Pipe Cell Window
ZZPZFU3-C320	2	Pipe Cell O-Ring
	1	*Pipe Cell Liner

\*The pipe cell liner is the same length as the pipe cell. Specify the corresponding part number from the table for the liner.

<b>Length</b>	<b>Part Number</b>
64 mm	910064
125 mm	910125
250 mm	910250

**For Analyzers Ranged:** CO 0-1% and higher, or  
CO<sub>2</sub> 0-2000 ppm and higher

ZZPZFU3-C080	1	Block Cell Window
ZZPZFU3-C090	1	Block Cell O-Ring

*Overnight shipment from stock is available for most items.  
Orders are subject to a \$50 minimum.*

PRICES SUBJECT TO CHANGE WITHOUT PRIOR NOTICE

## TABLE OF CONTENTS

	PAGE
1.GENERAL DESCRIPTION .....	1-1
2.SPECIFICATIONS .....	2-1
3.MEASURING PRINCIPLE .....	3-1
4.INSTALLATION .....	4-1
4.1 DESCRIPTION OF COMPONENTS .....	4-2
4.2 MOUNTING .....	4-3
4.3 PIPING .....	4-4
4.4 SAMPLING .....	4-4
4.4.1 SAMPLE GAS CONDITIONING .....	4-4
4.4.2 FLOW RATE OF SAMPLE GAS .....	4-5
4.4.3 PREPARATION OF CALIBRATION GAS .....	4-5
4.4.4 PURGING INTERIOR OF THE ANALYZER CASE .....	4-5
4.4.5 PRESSURE AT THE OUTLET OF SAMPLE GAS .....	4-5
4.5 WIRING .....	4-5
4.5.1 POWER SOURCE TERMINALS .....	4-6
4.5.2 COMP1 TERMINALS .....	4-8
4.5.3 COMP2 TERMINALS .....	4-9
4.5.4 AUTO CAL TERMINALS(OPTION) .....	4-10
5.OPERATION .....	5-1
5.1 OPERATION PROCEDURES .....	5-1
5.2 DESCRIPTIONS OF DISPLAY AND CONTROL PANEL .....	5-3
5.3 OUTLINE OF OPERATION FLOW .....	5-5
5.4 MEASUREMENT MODE .....	5-7
5.4.1 MEASURING .....	5-7
5.4.2 ZERO CALIBRATION .....	5-8
5.4.3 SPAN CALIBRATION .....	5-9
5.4.4 INITIAL CALIBRATION .....	5-11
5.5 SET MODE .....	5-12
5.5.1 SPAN GAS CONCENTRATION(SPAN VALUE) SETTING AND INDEPENDENT/DEPENDENT CALIBRATION SELECTION .....	5-13
5.5.2 SETTING OF ANALOG OUTPUT SIGNAL HOLDING .....	5-15
5.5.3 SETTING OF REMOTE RANGE(OPTION) .....	5-17
5.5.4 KEY LOCK ON/OFF SETTING .....	5-18
5.6 AUTOMATIC CALIBRATION (OPTION) .....	5-19
5.6.1 SETTING OF AUTOMATIC CALIBRATION START TIMER .....	5-21

5.6.2 SETTING OF AUTOMATIC CALIBRATION CYCLE TIME .....	5-22
5.6.3 SETTING OF CALIBRATION GAS FLOWING TIME .....	5-23
5.6.4 SETTING OF CALIBRATION GAS FLOWING MODE .....	5-24
5.6.5 SETTING OF AUTOMATIC CALIBRATION ON/OFF .....	5-25
6.MAINTENANCE .....	6-1
6.1 MEASURING CELL CLEANING .....	6-2
6.1.1 HOW TO DISASSEMBLE AND REASSEMBLE MEASURING CELL .....	6-2
6.1.2 HOW TO CLEAN CELL .....	6-7
7.TROUBLE SHOOTING .....	7-1
7.1 TROUBLE SHOOTING .....	7-1
7.1.1 DISPLAY OR INDICATING LIGHTS ARE NOT LIT ON .....	7-1
7.1.2 INDICATED VALUE IS NOT VARIED .....	7-2
7.1.3 INDICATED VALUE IS NOT STABILIZED .....	7-3
7.1.4 RESPONSE IS SLOW .....	7-4
7.1.5 RESPONSE IS SLOW AT RETURNING TO ZERO .....	7-4
7.1.6 LARGE DRIFT .....	7-5
7.2 CHECKING AND REPAIRING .....	7-7
7.2.1 DETECTOR .....	7-7
7.2.2 INFRARED SOURCE UNIT .....	7-8
7.2.3 CHOPPER .....	7-9
7.2.4 WINDOWS OF MEASURING CELL, DETECTOR AND INFRARED SOURCE UNIT .....	7-9
7.2.5 PIPING .....	7-10
7.2.6 PRINTED CCT. BOARD OF THE 1ST COMPONENT .....	7-10
7.2.7 PRINTED CCT. BOARD OF THE 2ND COMPONENT .....	7-12
7.3 ERROR CODES AND HOW TO REPAIR .....	7-13

## 1. GENERAL DESCRIPTION

FUJI Model ZRH Infrared Gas Analyzer is a multi-functional and easy-handling non-dispersive type infrared gas analyzer, employing highly sensitive and liable mass-flow sensor and microprocessor to measure concentrations of gaseous components like CH<sub>4</sub>, CO<sub>2</sub>, CO etc.

### FEATURES

- (1) Both zero calibration and span calibration can be performed by simple key operation.
- (2) Function of self-diagnosis is provided.
- (3) Function of automatic calibration can be added. (Option)
- (4) Function of remote selection of measuring ranges can be added. (Option)

### NOTE

Prior to operation of this analyzer, it is recommendable to the user to read through this Instruction Manual in order to ensure efficient operation and accurate measuring results

## 2. SPECIFICATIONS

- Repeatability : The 1st range(low range)  $\pm 0.5\%$  of full scale  
The 2nd range(high range)  $\pm 1.0\%$  of full scale
- Zero drift :  $\pm 2\%$  of full scale/week
- Span drift :  $\pm 2\%$  of full scale/week
- Response time : Electronic system response time (90%): 2 sec.  
Response time including gas replacing time of  
sample cell (90%): within 15 sec.  
(depending on cell length)
- Power source : AC 100V, 115V or 220V  $\pm 10\%$ , 50/60 Hz  
(Note: Refer to designation of TYPE NO.)
- Power consumption: 37VA max.
- Ambient temperature:  $-5 \sim +45^{\circ}\text{C}$
- Ambient humidity: Less than 90% RH
- Enclosure : Steel plate case, indoor use.
- Measurable gas : <Single gas component, dual ranges measuring>  
components and  $\text{CO}_2$ , CO,  $\text{CH}_4$  (Low range/High range) ;  
measuring ranges 0~0.05/0.1% (unavailable for  $\text{CH}_4$ ),  
0~0.1/0.2%, 0~0.2/0.5%, 0~0.5/1%  
0~1/2%, 0~2/5%, 0~5/10%, 0~10/20%  
0~20/50%, 0~50/100%,  
  
<Dual gas components, single range measuring>  
 $\text{CO}_2/\text{CO}$  ;  
0~20%/0~0.05%, 0~20%/0~0.1%
- Measuring principle: Infrared ray absorption, non-dispersive type  
deflection method, single IR source single  
beam system.

- Output signal : Output 1; DC 0 ~ 1V  
Output 2; DC 4 ~ 20mA (allowable load resistances less than 550Ω).  
To-order production of either DC 0 ~100mV or DC 0 ~10mV (output resistance less than 100 Ω to be available as non-standard.
- Contact output : 1'a'contact at analyzer fault  
Rating: AC250V, 2A (resistance load)
- Overall dimensions : Rack mounted type 133 x 483 x 448 mm  
(H x W x D) Panel flush mounted type 133 x 443 x 448 mm  
Desk top type 145 x 443 x 448 mm
- Weight : Approx. 12 kg
- Color of finish : MUNSELL 5Y8/1
- Indication : Concentration indication(main display screen)  
4-digit LED display  
Parameter indication (sub-display screen)  
4-digit LED display
- Hold of output signal : Output signal just prior to calibration are held during either manual or automatic calibration.  
Hold or non-hold both selectable.
- Sample gas temperature : 0 ~ 50 °C
- Warm-up time : Approx. 4 hours after power switch on
- Materials of gas contacting parts : Measuring cell: stainless steel type 304  
NEOPRENE® rubber  
Window for infrared ray: CaF<sub>2</sub> or Sapphire  
Internal piping TEFLON® tube  
TOALON® tube



- Inlet & outlet dia.: RC 1/4 (PT 1/4) female threads or  
of sample gas and NPT 1/4 female threads.  
purging gas inlet
- Measuring gas flow : 1 ℓ /min. ± 0.5 ℓ /min.  
rate
- Purging gas flow : Approx. 1 ℓ /min. (by occasional demands)  
rate

#### ADDITIONAL SPECIFICATIONS

- Remote selection : Selection of measuring range by external  
of measuring range signal available.  
1st range selection signal:voltage input DC5V
- Contact output of : 1'a'contact output for 1st(low) range  
range rating: AC250V, 2A (resistance load)  
identification  
signal
- Automatic : Automatic zero & span calibration at preset  
calibration cycle time and due to external start signal.  
Calibration gases flow orderly by sequential  
driving of external solenoid valves.
- Nos. of components : Simultaneous calibration of max.2 gas  
for calibration components available.
- Zero calibration : Fixed at 0%.  
point
- Span calibration : Setting available in range of 0~ 100%  
point of full scale
- Calibration start : To be started by either built-in timer or  
remote start signal.

- Flowing mode of calibration gas at calibration : (1) Zero gas  
 (2) Zero gas - span gas 1  
 (3) Zero gas - span gas 2  
 (4) Zero gas - span gas 1 - span gas 2
- Calibration gas flowing time at calibration : Setting range from 100 to 599 sec.
- Cycle time of auto-matic calibration : Setting range from 1 to 199 hours (pitch by 1 hour)
- Automatic calibration error alarm : Output signal at error during automatic calibration.
- Contact outputs : 1'a'contact during calibration  
 Rating : AC250V, 2A (resistance load)  
 1'a'contact at calibration error  
 Rating : AC250V, 2A (resistance load)  
 1'a'contact for each solenoid valve drive  
 Rating : AC250V, 2A (resistance load)
- Remote starting of automatic calibration : Remote starting signal: voltage input DC5V

### 3. MEASURING PRINCIPLE

The principle of composition of the FUJI Model ZRH Infrared Gas Analyzer is shown in Fig.3.1.

Infrared light emitting from an Infrared Source① is intermitted by a Chopper② driven by a Chopper Motor③ in a certain frequency, then led into a Measuring Cell④. The infrared light beam is partially absorbed into the measured component in the Measuring Cell and the unabsorbed portion reaches a Detector⑤, which is provided with a Front Chamber and a Rear Chamber, both normally being filled with the same gas component as the gas to be measured.

When infrared light is led into the detector, the gases filling in both chambers absorb the light and expand.

Since the Detector is so designed as to produce an expansion difference between the Front and Rear Chambers, a slight gas flow is produced in a Mass-flow Sensor⑥ and this slight flow generates output voltage in the sensor as shown in Fig.3.2.

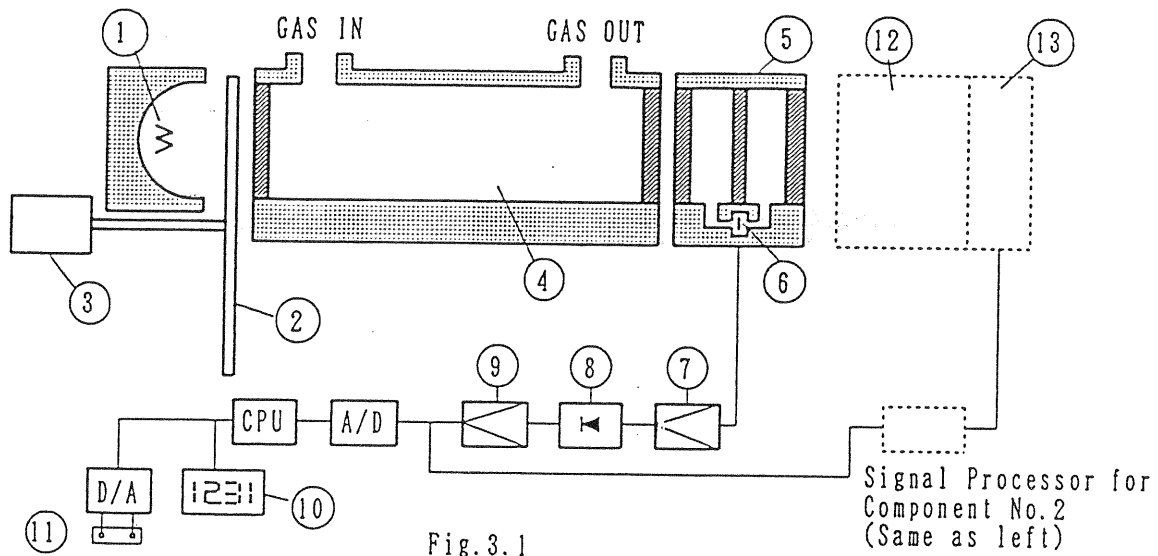

Fig.3.1

- |                     |                    |
|---------------------|--------------------|
| ①: Infrared Source  | ⑨: DC Amplifier    |
| ②: Light Chopper    | ⑩: Display Panel   |
| ③: Chopper motor    | ⑪: Output Terminal |
| ④: Measuring Cell   | ⑫: Measuring cell  |
| ⑤: Detector         | for No.2 component |
| ⑥: Mass-flow Sensor | ⑬: Detector for    |
| ⑦: AC Amplifier     | No.2 Component     |
| ⑧: Rectifier        |                    |

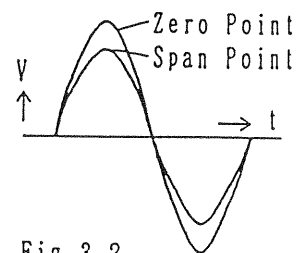

Fig.3.2

Output signal generated in the sensor is amplified by an AC Amplifier ⑦, then converted to DC voltage by a Rectifier ⑧.

The converted DC signal is amplified by a DC Amplifier ⑨, then converted by an A/D Converter and after being processed through concentration computing, temperature compensation and linearizing in a micro-processor, the concentration of measured component is displayed in 4-digit on a Display panel ⑩ in digital form and simultaneously a D/A converted signal is transmitted from an Output Terminal ⑪ as an analog output signal.

When sample gas contains such interfering gas components as absorption range partially overlapping with the gas component to be measured, the same expansion as mentioned above is produced in both chambers of the detector, however, since both expansions are designed for almost the same volume, mutual influence owing to interfering gas component can be minimized.

A dual components analyzer has additional Measuring Cell ⑫, Detector ⑬ and signal processing electronics the same as for the 1st component. As shown in Fig.3.1, they proceed with the same measuring process.

## 4. INSTALLATION

### WARNINGS

- Dangerous voltages are present at power supply terminals and inside the instrument assembly.
- Be careful with gas leakage, especially in case of toxic gas and other hazardous gas to people.

### CAUTIONS

- Select an adequate installing location.  
Install the analyzer so as not to be subjected to high and/or fluctuating temperature, strong heat radiation or direct sun light exposure.  
In case when the instrument is installed outdoors, select weather protected area.
- Avoid the location with frequent and/or severe vibration.
- Avoid the location with corrosive and flammable gas in atmospheric air.

### NOTES

- Check whether the followings are contained or not at time of unpacking.

Item	Quantities
◦ Instrument -----	1
◦ Power Source Fuse -----	2
◦ Test report -----	1
◦ Instruction Manual -----	1
◦ Mounting Screw -----	4 (in case of panel mounting type)

## 4.1 DESCRIPTIONS OF COMPONENTS

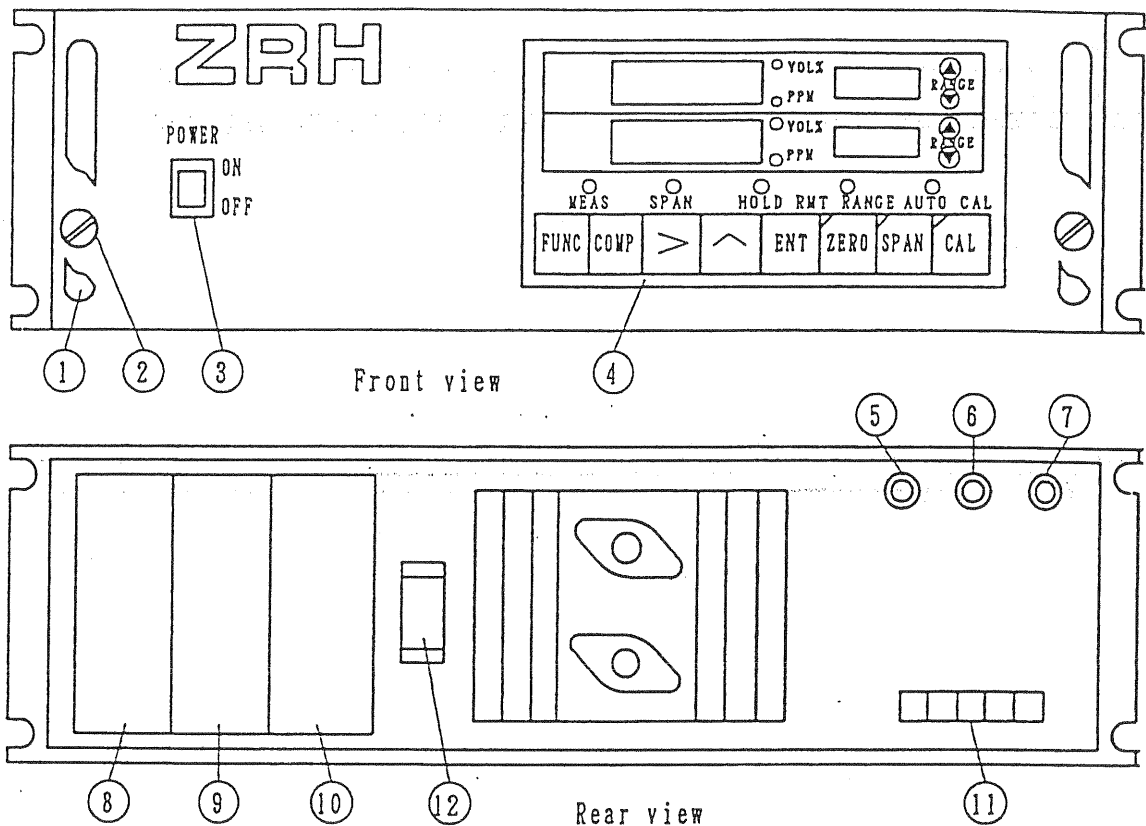

- |                           |   |
|---------------------------|---|
| ① Handle                  | ⑨ COMP 2 Terminals                                    |
| ② Set Screw               | Attached to the dual components analyzer              |
| ③ Power Switch            |   |
| ④ Display & Control Panel | ⑩ AUTO CAL. Terminals                                 |
| ⑤ Sample Gas Inlet        | Attached to the analyzer with auto-calibration option |
| ⑥ Sample Gas Outlet       |   |
| ⑦ Purge Gas Inlet         | ⑪ Power Supply & Grounding Terminals                  |
| ⑧ COMP 1 Terminals        | ⑫ Pin connector (for manufacturer's internal use)     |

### NOTE

The Pin connector ⑫ is intended to be used only in the manufacturing process. Do not remove the cover and do not make any electrical connections on it.

## 4.2 MOUNTING

3 ways of mounting (19" rack mount, panel flush mount and desk top) are available. Prepare for mounting referring to data listed in a table below (Dimensions in mm).

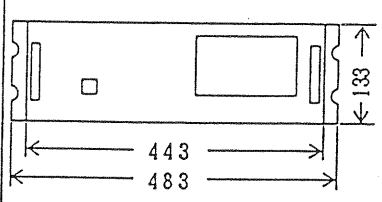
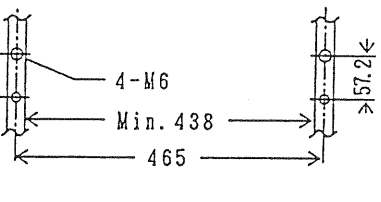
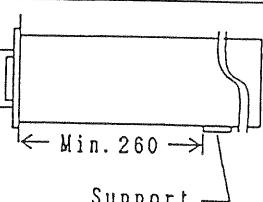
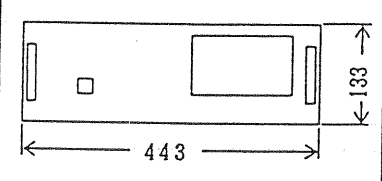
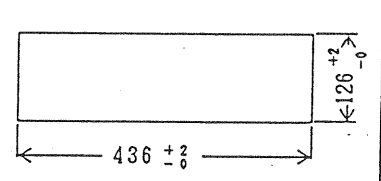
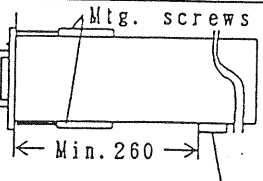
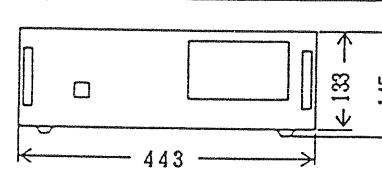
	Ext. Dimensions of Analyzer	Dimensions for Mounting	Mounting Method
19" Rack Mount			
Panel Mount			
Desk top			

### CAUTIONS

- Mount front side of the analyzer so as to be vertically positioned.
- In case of both mounting on panel and 19" rack, hold the rear side with such support as to be able to hold 10kg or more weight.

### 4.3 PIPING

Connect piping with gas inlet-outlet on the rear upper side of the analyzer. Connect the analyzer with a sampling system by means of corrosive-resistant tubing like TEFLON® stainless steel or polyethylene etc. Do not use rubber or soft vinyl tubing even in any uncorrosive case to avoid incorrect indication due to adsorption of gas onto piping materials. Rc1/4 (PT1/4) or NPT1/4 female threads connectors are equipped for piping connection.

Be sure to minimize piping length as short as possible in order to ensure quicker response. Adequate tubing bore is 4 mm.

Use clean tubings and connections as dust inhaling may cause improper operation.

Location of pipe connectors on the rear panel of the analyzer is shown below.

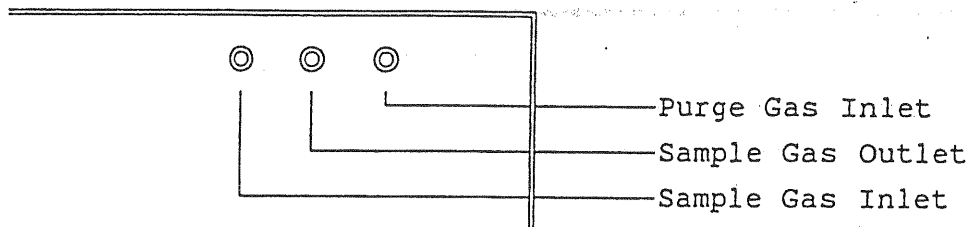

### 4.4 SAMPLING

#### 4.4.1 SAMPLE GAS CONDITIONING

(1) Remove dust in sample gas completely through filters.

For final stage filtering, use a filter capable of removing particles of dust larger than  $0.3\mu$ .

(2) Dew point of sample gas must be lower than ambient temperature in order to eliminate moisture to drain inside the analyzer.

In case that moisture is contained in sample gas, bring dew point of the sample gas down to about  $0^{\circ}\text{C}$  through a dehumidifier.

(3) When  $\text{SO}_2$  mist is contained in sample gas, remove it through a mist-filter and cooler etc. Remove other mist by similar procedures.

(4) Note and take care, the life of the analyzer is to be shortened when such heavy corrosive gases as  $\text{Cl}_2$ ,  $\text{F}_2$ , &  $\text{HCl}$  etc. are much contained in sample gas.

(5) Allowable temperature range of sample gas is  $0^{\circ}\text{C} \sim 50^{\circ}\text{C}$ .

Be careful not to bring hot gas into the analyzer directly.



#### 4.4.2 FLOW RATE OF SAMPLE GAS

Keep flow rate of sample gas at 1 l /min.  $\pm$  0.5 l /min.

Prepare flowmeter so as to measure flow rate.

#### 4.4.3 PREPARATION OF CALIBRATION GASES

Prepare calibration gases for zero and span calibration.

zero gas	N <sub>2</sub> gas
span gas	Each component should have concentration more than 80% of full scale.

#### 4.4.4 PURGING INTERIOR OF THE ANALYZER CASE

Purging inside the analyzer is generally unneeded, however, proceed purging with instrumentation air or N<sub>2</sub> gas for the following cases.

Purging flow rate is to be approx. 1 l /min.

When dust & mist are contained in purge gas, utilize it after their complete removal.

- (1) When corrosive gas exists in the environmental air of the installing location.
- (2) When the same or interfering gas component with the gas to be measured, exists in the environmental air of the installing location.

#### 4.4.5 PRESSURE AT THE OUTLET OF SAMPLING GAS

Keep pressure at the outlet of sample gas so as for it to be atmospheric pressure.

## 4.5 WIRING

### CAUTION

Do not locate analyzer near to the electric apparatus to generate electric noises. (Induction furnace & electric welder etc.).

When the analyzer is operated near to such electric apparatus be sure to separate the power source to avoid noise.

In case the noise from relay or solenoid valve etc. influences the analyzer through the power source, provide a ballistor(example: Fuji Electric Type No.ENA211-2) or a spark-killer(example: Okaya Type No.S1201) with the noise generating apparatus as shown in Fig.4.5.1

Be sure to mount the above as close as possible to such noise generating sources.

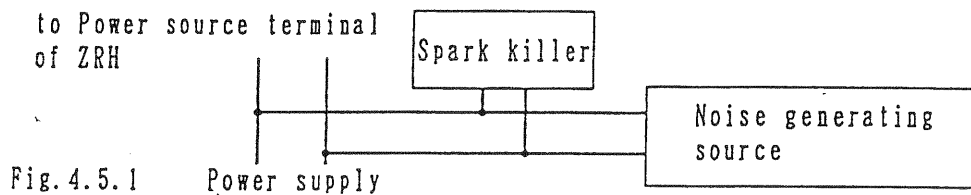

Fig.4.5.1

All input & output terminals are on the rear panel of the analyzer.

Proceed wiring of each terminal as shown in Fig.4.5.2.

Terminal screw is M3.5.(Power source terminal is M4.)

Use shield wire for wiring of output signal in order to reduce the influence of noise.

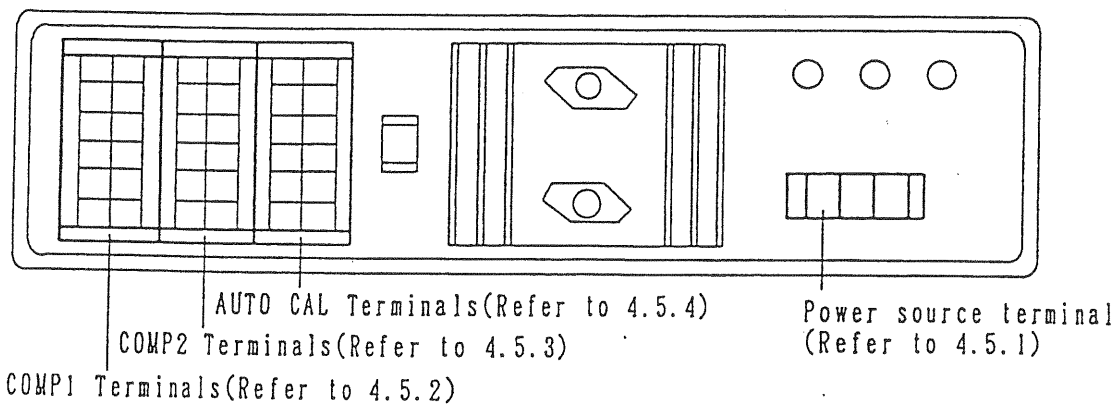

Fig.4.5.2 Rear panel

## 4.5.1 POWER SOURCE TERMINALS

### CAUTION

Ensure to check voltage of power source to be identical with the one specified on the name plate of the analyzer, otherwise it may be broken.  
Proceed ground earthing with earth terminal to eliminate electrical hazards.

Layout of power source terminals are shown in Fig. 4.5.3.  
Proceed earthing of earth terminal and connect power source terminals to a power source.  
Use crimp terminals (for M4 screw) for connecting.

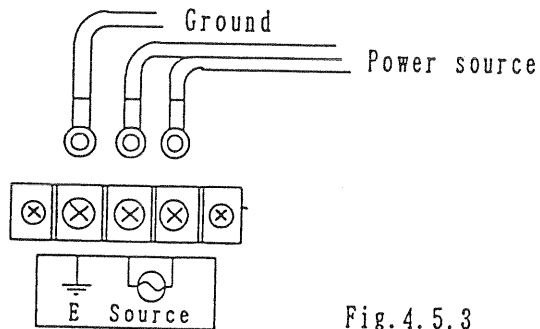

Fig.4.5.3

## 4.5.2 COMP1 TERMINALS

COMP1 Terminals are input & output terminals for the 1st measuring component. Connection is to be referred to Fig. 4.5.4.

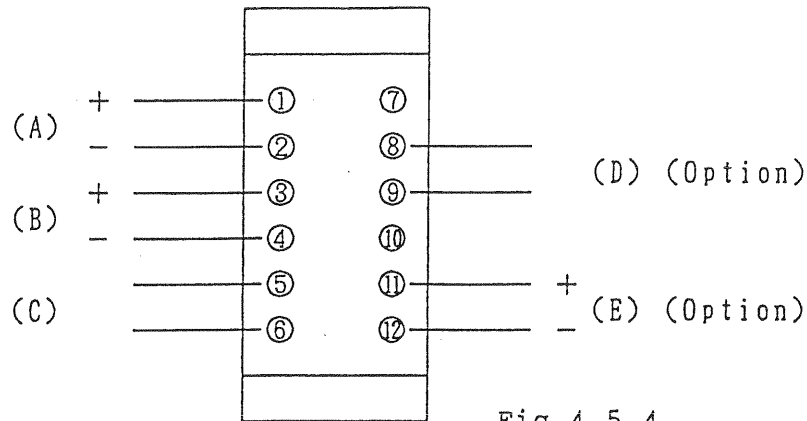

Fig.4.5.4

- (A) Voltage output signal : DC 0~ 1V
- (B) Current output signal : DC 4~ 20mA
- (C) FAULT contact output : 1'a'contact  
Rating: AC 250V, 2A (resistance load)  
Make-contact output for occasional error in analyzer. Refer to 7.3 Error codes & how to recover regarding details of fault.
- (D) Contact output of measuring range identification : 1'a'contact  
Rating: AC 250V, 2A (resistance load)  
At selection of the 1st range:  
⑧ & ⑨ close  
At selecting of the 2nd range:  
⑧ & ⑨ open
- (E) Remote range selection input : DC 5V  
During DC 5V is input to terminals ⑪ & ⑫, the 1st range is selected.  
When terminals ⑪ & ⑫ are opened or given 0V, the 2nd range is selected.

### 4.5.3 COMP2 TERMINALS

COMP 2 Terminals are input & output terminals for 2nd measuring component. Connection is to be referred to Fig. 4.5.5.

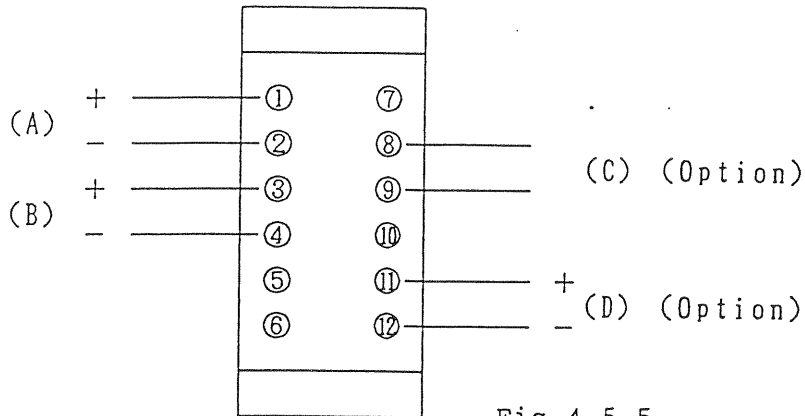

Fig.4.5.5

- (A) Voltage output : DC 0~ 1V  
signal
- (B) Current output : DC 4~ 20mA  
signal
- (C) Contact output of : 1'a'contact  
measuring range Rating: AC 250V, 2A (resistance load)  
identification At selection of the 1st range;  
⑧ & ⑨ close  
At selecting of the 2nd range;  
⑧ & ⑨ open
- (D) Remote range : DC 5V  
selection input During DC 5V is input to terminals  
⑪ & ⑫, the 1st range is selected.  
When terminals ⑪ & ⑫ are opened or given  
0V, the 2nd range is selected.

#### 4.5.4 AUTO CAL TERMINALS (OPTION)

AUTO CAL Terminals are input & output terminals for automatic calibration and the connection is shown in Fig. 4.5.6.

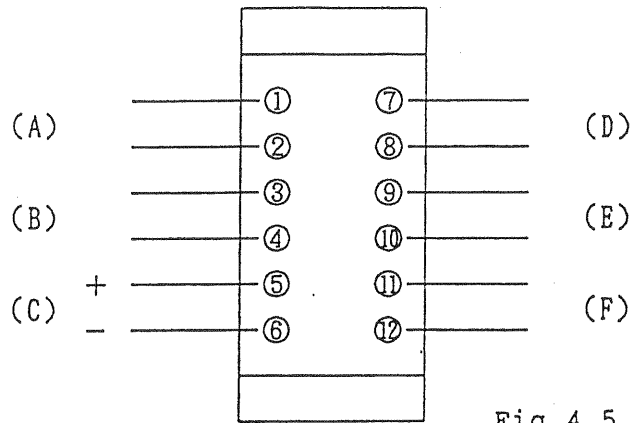
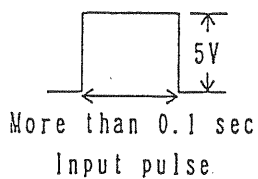

Fig.4.5.6

- |  |  |
|--|--|
| (A) Contact output during calibration                | : 1'a'contact<br>Rating: AC 250V, 2A(resistance load)<br>Make-contact output to indicate automatic calibration taking place.   |
| (B) Contact output of error in automatic calibration | : 1'a'contact<br>Rating: AC 250V, 2A(resistance load)<br>Make-contact output for error occurring in analyzer during automatic calibration, which works simultaneously with the contact output FAULT.<br>If error occurs, corresponding error code is displayed.<br>For details of error codes refer to 7.3 Error codes & how to recover. |
| (C) Remote start input                               | : DC 5V square signal longer than 100msec. in duration.<br>Input to start automatic calibration by external signal. When the pulse shown left is input to terminals ⑤ & ⑥ automatic calibration is to start.   |



- (D) Contact output : 1'a'contact  
for zero gas Rating: AC 250V, 2A(resistance load)  
Make-contact output to open solenoid  
valve for zero gas flowing.
- (E) Contact output : 1'a'contact  
for span gas 1 Rating: AC 250V, 2A (resistance load)  
Make-contact output to open solenoid  
valve for span gas of the 1st component  
flowing.
- (F) Contact output : 1'a'contact  
for span gas 2 Rating: AC 250V, 2A (resistance load)  
Make-contact output to open solenoid  
valve for span gas of the 2nd component  
flowing.

CAUTION

Keep each unused terminal open so as not to make damage to  
analyzer by short-circuit or misconnection etc.

## 5. OPERATION

### 5.1 OPERATION PROCEDURES

Proceed the followings for getting an analyzer into operation

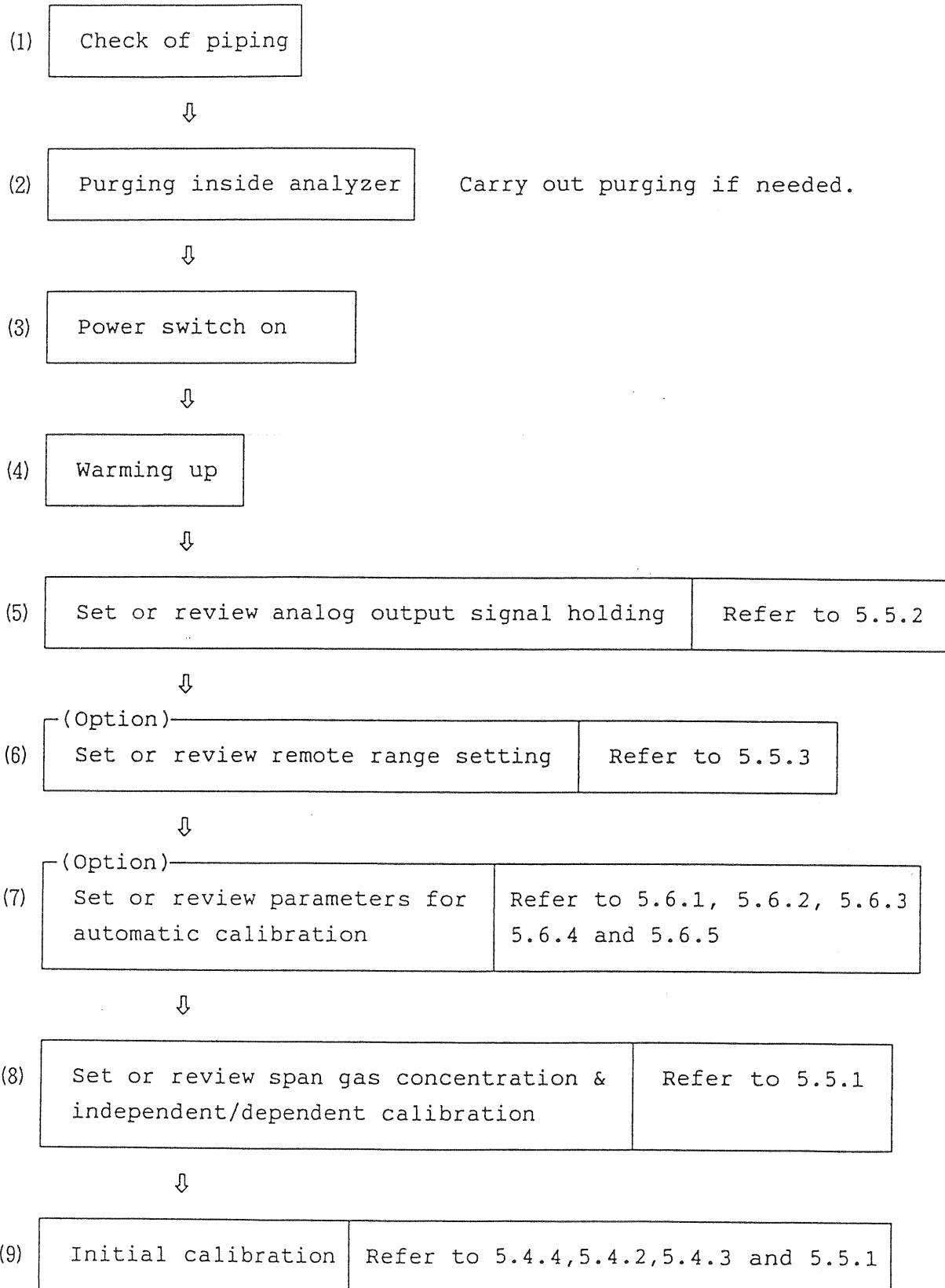



↓

(10)	Set or review key lock ON/OFF	Refer to 5.5.4
------	-------------------------------	----------------

↓

(11)	Introduction of sample gas
------	----------------------------

(Start of measuring)

↓

(End of measuring)

(12)	Stop sample gas and purge the analyzer
------	--

Supplemental explanations to above described items

- (1) Check of piping  
Check whether piping are rightly made.
- (2) Purging inside analyzer  
Check flow rate of purging gas when purging is needed.  
(Refer to 4.4.4.)
- (3) Power switch on  
When power source is switched on, analyzer is operating in  
function mode "Measuring".
- (4) Warming up  
After power source is switched on, warm up the analyzer.  
Approx. 4 hours are needed for warming up to obtain the specified  
performances in the specifications, but indication come to be  
stabilized approx. 2 hours after.  
During warming up, reviewing all configuration parameters is  
recommended to get well acquainted with analyzer performance.
- (9) Initial calibration  
Proceed zero & span manual calibration according to 5.4.4.  
If initial calibration has been surely completed in manufacturer  
or distributor, proceed ordinary zero & span calibration instead,  
either automatic or manual and either independent or dependent.
- (12) Stop flowing-in of sample gas then proceed purging of measuring  
cell inside with dry nitrogen gas for 10 minutes.  
If switching off power source, refer notes on the next page.

## NOTES

Even after switching off the power source, all preset parameters is stored and kept in non-volatile memory. However, time until the next automatic calibration stored in a timer expires after 4 hours from power source turned off. In this case, reset the timer again at re-starting.

### 5.2 DESCRIPTIONS OF DISPLAY AND CONTROL PANEL

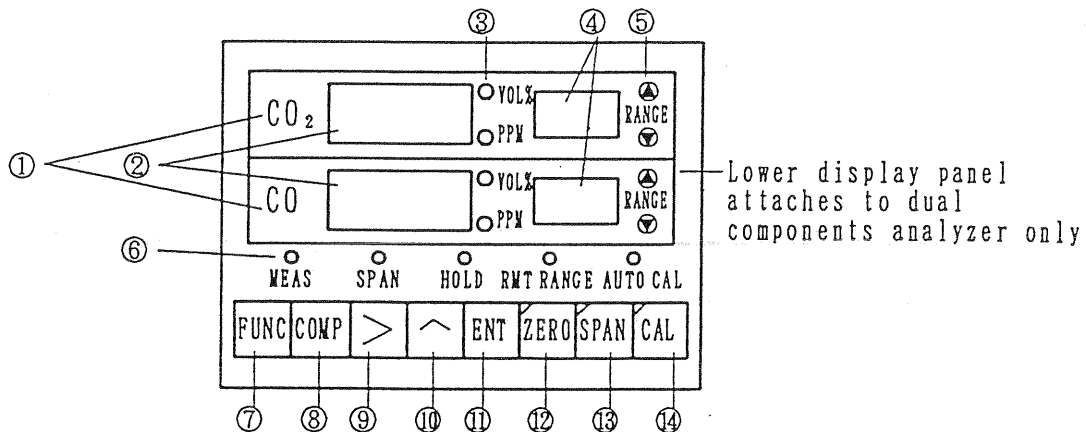

NAME	DESCRIPTIONS
① Name of measured components	Indicating measured components
② Main display screens	Indicating measured concentration, and also indicating each parameter of automatic calibration etc. in set mode
③ Indicating light of measuring unit	Measuring unit of concentration display to be indicated.
④ Sub display screens	Besides displaying of measuring range, error code & parameters etc. also to be displayed.
⑤ Measuring range selection keys	To be utilized for range selection. ▲ : Selection button for high range ▼ : Selection button for low range

⑥ Function indicating lights

In case of single range, both do not work even if depressed.

Each light shows the following status.

MEAS : Lighting in measurement mode.

SPAN : Blinking in function mode of span gas concentration setting

HOLD : Blinking in hold setting mode, and keeping lit during hold function working.

RMT RANGE: Blinking in remote range setting mode, keeping lit during remote range function working.

AUTO CAL : blinking in automatic calibration setting mode, and keeping lit during automatic calibration function working.

⑦ [FUNC] key

Setting mode to be changed-over at every key depression.

⑧ [COMP] key

Change-over of components for parameter setting in set mode.

⑨ [ > ] key

A changeable digit on the display shifts down by every key depression.

⑩ [ ^ ] key

Value of the chosen digit to be increased by every key depression.

⑪ [ENT] key

Set parameters to be stored and become effective by key depression.

⑫ [ZERO] key

To be used for zero calibration (zero key indicating light on up-left corner of key blinking during zero calibrating.)

⑬ [SPAN] key

To be used for span calibration (span key indicating light on up-left corner of the key blinking during span calibration.)

⑭ [CAL] key

To be used for starting of manual calibration.

While zero key indicating light blinking, CAL key depression leads to zero calibration, while span key indicating light blinking, it leads to span calibration.

### 5.3 OUTLINE OF OPERATION FLOW

As under-shown, function to be changed-over by FUNC key pressing down.

Key	Function (Reference pages)	Main/Sub display	Function display light
FUNC	[Measurement mode] Measuring (P.5-7)	Measuring value/ Measuring range	MEAS lighting on
↓	[Set mode]		
FUNC	Span gas concen- tration setting (P.5-13)	Span value/ Measuring range	Span blinking
↓	Hold setting (P.5-15)	"HoLd"/ "ON"or"OFF"	HOLD blinking
FUNC	Remote range setting(option) (P.5-17)	"r.rAG"/ "ON"or"OFF"	RMT RANGE blinking
	Automatic calibration (option)		
FUNC	Calibration start timer (P.5-21)	"Strt"/Time	AUTO CAL blinking
↓	Calibration Cycle time setting (P.5-22)	"CyCL"/Time	AUTO CAL blinking
FUNC	Calibration gas flowing time setting (P.5-23)	"F.SEC"/Time	AUTO CAL blinking
↓			

	Calibration gas flow mode setting (P.5-24)	"FLno."/	AUTO CAL blinking
FUNC ↓		Mode No.	
	Automatic calibration on/off (enabling or not) (P.5-25)	"A.CAL"/ "ON"or"OFF"	AUTO CAL blinking
FUNC ↓			
	Key lock on/off (enabling or not) (P.5-18)	"LOC."/	
FUNC ↓		"ON"or"OFF"	
	(To function mode measuring)		
	[Measurement mode]		
ZERO	Zero calibration	Measuring value/ Measuring range	Zero key indicating light blinking
SPAN	Span calibration	Measuring value/ Measuring range	Span key indi- cating light blinking

#### NOTES

- When the analyzer operating in set mode, the analog output signal is held at the value just prior the mode change.
- In case of no addition of optional function, the relating parameters of un-added optional function are not displayed.

## 5.4 MEASUREMENT MODE

The measurement mode consists of three function modes of "Measuring", "zero calibration", and "Span calibration".

When the analyzer operates in the measurement mode, the indicating light MEAS is lit.

The analyzer operates in the function mode "Measuring" when power switch is turned on.

When the indicating light RMT RANGE is not lit in the measurement mode, high and low measuring ranges are selectable by depressing range selection keys.

The selected range value (max. value of the selected measuring range) is displayed on the sub-display screen.

### 5.4.1 MEASURING

Concentration reading of the measured component is displayed on the main display screen.

The selected measuring range value is displayed on the sub-display screen.

The measuring unit of concentration display is indicated by the unit indicating lights. (Fig. 5.4.1)

When the measuring range is selectable by an external signal, the indicating light RMT RANGE is lit.

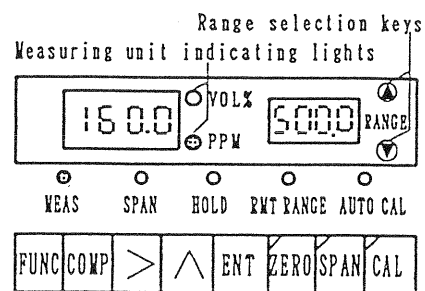

Fig. 5.4.1

## 5.4.2 ZERO CALIBRATION

Depress [ZERO] key.

The ZERO key indicating light at the up-left corner of [ZERO] key blinks and it indicates that the analyzer is ready for zero calibration.

The indicating light HOLD is lit when the holding function is set as ON and the analog output signal is kept constant at the value immediately before [ZERO] key is depressed. (Fig. 5.4.2 a)

If the analyzer with automatic calibration option is used, the output signal for energizing a solenoid valve is turned on and zero gas is introduced into the analyzer.

The zero gas should be introduced into the analyzer manually if the analyzer without automatic calibration option is used.

If the dual ranges analyzer is used, select the range for zero calibration.

When displayed concentration reading on the main display screen reaches its final value, depress [CAL] key.

The CAL key indicating light at the up-left corner of [CAL] key is lit and it indicates that the calibration is taking place.

The ZERO key indicating light changes simultaneously from blink to continuous lighting. (Fig. 5.4.2 b)

In the dual components analyzer, zero calibration is performed for both measured components simultaneously.

Lighting interval of the CAL key indicating light is normally very short, but if displayed concentration does not reach its final value the analyzer waits for a maximum 30 seconds for stabilization of measured value.

If displayed concentration is not stabilized in 30 seconds,

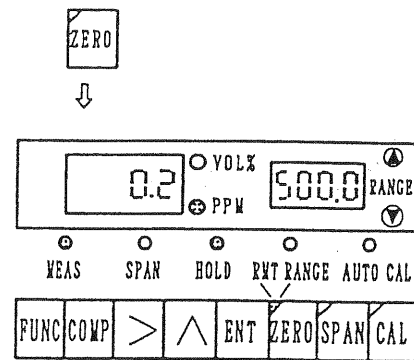

Fig. 5.4.2a

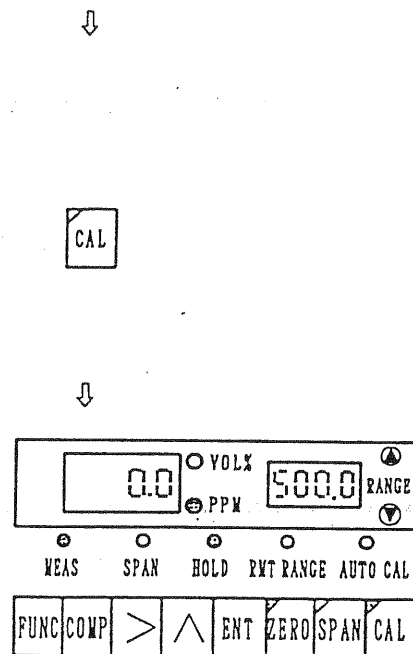

Fig. 5.4.2b

the calibration is cancelled.

After finishing zero calibration, the ZERO key indicating light and the CAL key indicating light are turned off and if the indicating light HOLD was lit, it is also turned off and then return to the function mode "Measuring".

#### NOTE

If zero calibration should be discontinued after starting, press [ZERO] key again.

The ZERO key indicating light is turned off and the analyzer returns to the function mode "Measuring" without performing zero calibration.

When [ZERO] key is depressed, and the holding function is set as ON, the analog output signal is kept constant at the value immediately before [ZERO] key is depressed.

When the zero calibration ends, the holding function is released. Therefore, before the sample gas is fully introduced into the analyzer, the analyzer transmits an analog signal different from measured component concentration for a short duration.

### 5.4.3 SPAN CALIBRATION

Concentration of span gas(span value) should be set before getting the analyzer into operation.

If not, span value should be set before calibration.

For this purpose, function mode "Span gas concentration(span value) setting and independent/dependent calibration selection" in set mode, should be selected by depressing [FUNC] key, and span value should be set beforehand. (Refer to 5.5.1, P.5-13)



Depress [SPAN] key.

The SPAN key indicating light at the up-left corner of [SPAN] key blinks and it indicates that the analyzer is ready for span calibration.

The indicating light HOLD is lit when the holding function is set as ON and the analog output signal is kept constant at the value immediately before [SPAN] key is depressed. (Fig. 5.4.3 a)

If the analyzer with automatic calibration option is used, the output signal for energizing a solenoid valve is turned on and span gas is introduced into the analyzer.

Span gas should be introduced into the analyzer manually if the analyzer without automatic calibration option is used.

If the dual components analyzer is used, the main display screen of one component to be calibrated blinks.

The component to be calibrated can be changed by depressing [COMP] key.

Select the correct component.

If the dual ranges analyzer is used, the range for calibration must be selected.

When displayed concentration on the main display screen reaches its final value, depress [CAL] key.

The CAL key indicating light at the up-left corner of [CAL] key is lit and it indicates that the calibration is taking place.

The SPAN key indicating light changes simultaneously from blink to continuous lighting. (Fig. 5.4.3 b)

Lighting interval of the CAL key indicating light is normally very short, but if displayed concentration does not reach its final value the analyzer waits for a maximum 30 seconds for stabilization of measurement.

If displayed concentration is not stabilized in 30 seconds, the calibration is cancelled.

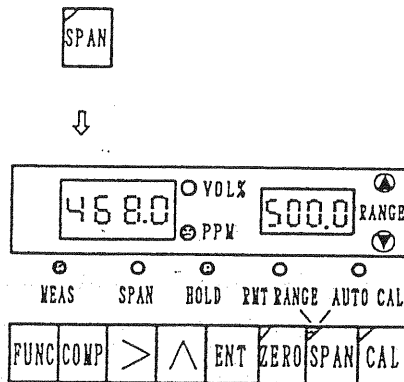

Fig. 5.4.3a

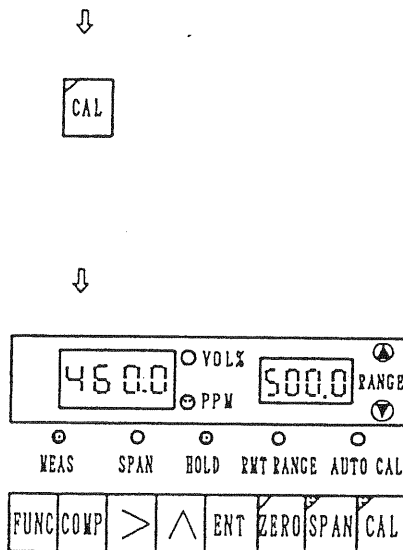

Fig. 5.4.3b

After finishing span calibration, the SPAN key indicating light and the CAL key indicating light are turned off and if the indicating light HOLD was lit, it is also turned off and then return to the function mode "Measuring".

#### NOTE

If span calibration should be discontinued after starting, press [SPAN] key again. The SPAN key indicating light is turned off and the analyzer returns to the function mode "Measuring" without performing span calibration.

When [SPAN] key is depressed, and the holding function being set as ON, the analog output signal is kept constant at the value immediately before [SPAN] key is depressed.

When span calibration ends, the holding function is released.

Therefore, before the sample gas is fully introduced into the analyzer, the analyzer transmits an analog signal different from measured component concentration for a short duration.

#### 5.4.4 INITIAL CALIBRATION

Before getting the analyzer into operation, zero/span calibration should be completed in each range and for each measured component. Calibration for this purpose is called the initial calibration. Select function mode "Span gas concentration setting and independent/dependent calibration selection".

Set correct span gas concentration and select independent calibration for the dual ranges analyzer. (Refer to 5.5.1, P.5-13 )

After finishing up the above-mentioned preparation, return to the function mode "Measuring" by depressing [FUNC] key repeatedly, and perform manual zero and span calibration.

For the dual ranges analyzer, zero and span calibration should be performed in each range independently.

For the dual components analyzer, perform zero calibration and span calibration of each component.

Move to set mode after completion of the initial calibration, and set or review various configuration parameters except span gas concentration setting.

## 5.5 SET MODE

Set mode is operating mode in which configuration parameters & data of the analyzer is reviewed or set.

This mode consists of following 3 basic function modes;

5.5.1 span gas concentration setting and independent/dependent calibration selection

5.5.2 Hold(Freeze) of analog output signal setting

5.5.4 Key lock ON/OFF setting

For the analyzer with remote range option,

5.5.3 Remote range setting

and further, for the analyzer with automatic calibration option,

5.6.1 Setting of automatic calibration start timer

5.6.2 Setting of automatic calibration cycle time

5.6.3 Setting of calibration gas flowing time duration

5.6.4 Setting of calibration gas flowing mode

5.6.5 Setting of automatic calibration ON/OFF. are added.

In set mode the indicating light MEAS is turned off and the analog output signal is kept constant at the value immediately before moving to set mode.

Though many optional functions are included in set mode, parameters and data concerning them are not displayed for the analyzer without a corresponding option.

In the dual components analyzer, there are data and parameters to be set for each measured component.

In the function mode to set or review data and parameters for each component respectively, the main display of the currently selected component blinks.

Depressing [COMP] key, another component is selected and the display on the main display screen of the corresponding component starts blinking. (Fig. 5.5)

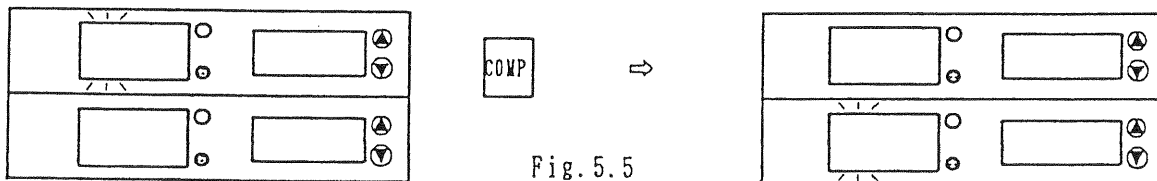

Fig. 5.5

### NOTE

Configuration parameters and data are stored in a non-volatile memory in the analyzer and kept while the power is off.

### 5.5.1 SPAN GAS CONCENTRATION (SPAN VALUE) SETTING AND INDEPENDENT/DEPENDENT CALIBRATION SELECTION

In this function mode, concentration value of span gas and the calibration method for the dual ranges analyzer are set or reviewed. The setting or reviewing procedure of span gas concentration is as follows.

Depress [FUNC] key (repeatedly if necessary) until indicating light SPAN starts blinking.

Blink of the indicating light indicates that the analyzer is functioning in this mode.

Span value currently used is displayed on the main display screen. (Fig. 5.5.1 a)

If the dual ranges analyzer is used, depress range selection keys, the span value for selected range appears on the main display screen.

If the current setting is applicable, move to other function by depressing [FUNC] key or select independent or dependent calibration. (Refer next page) Follow the procedure described below when span value setting should be changed.

Depress [ > ] or [ ^ ] or [ COMP ] key. The number of the digit which can be changed blinks on the main display screen. (Fig. 5.5.1b)

Select the measuring range or the component to be changed.

Depress [ COMP ] key to select the component.

The digit which can be changed shifts according to every depress of [ > ] key.

In every depression of [ ^ ] key, the digit on the screen increases one by one (1, 2 ..... 9 → 0).

After setting a new span value for each

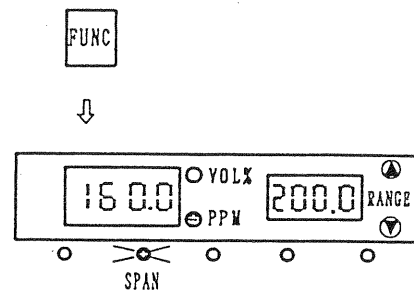

Fig. 5.5.1a

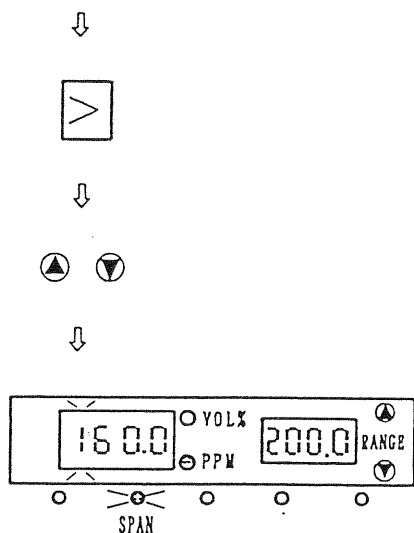

Fig. 5.5.1b

component or for each range, depress [ENT] key to write the new values into the memory.

Blink of the main display screen stops when the new value is stored.

There are two methods of performing calibration for high and low measuring ranges of the dual ranges analyzer.

One is performing calibration independently in each range and the other is performing calibration in one range with dependent calibration calculation for the other range.

In independent calibration, calibration only in one range is necessary.

The other range is calibrated automatically by calculation.

The dependent calibration is mostly used, but in the initial calibration independent calibration must be chosen.

(Refer to 5.4.4, P.5-11)

Change setting according to the following procedure.

Depress [ > ] or [ ^ ] or [ COMP ] key.

Displayed value on the main display screen blinks. (Fig. 5.5.1 c)

Depress [ CAL ] key. Message "S.CAL" appears on the main display screen, and "on" or "OFF" is displayed on the sub-display screen. "on" denotes dependent calibration and "OFF" denotes independent calibration. (Fig. 5.5.1d)

When [ ^ ] key is depressed, displayed number "on" changes to "OFF" or vice versa. Depress [ ENT ] key to store the new parameter into the memory.

Blink of the sub-display screen stops after storing.

High or low range selection does not affect this setting.

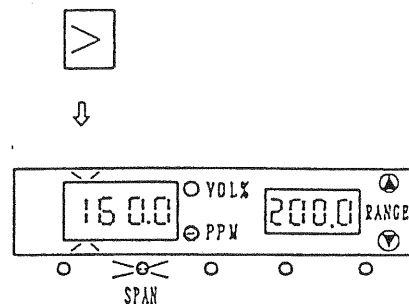

Fig. 5.5.1c

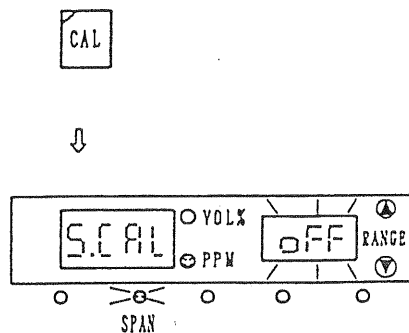

Fig. 5.5.1d

### 5.5.2 SETTING OF ANALOG OUTPUT SIGNAL HOLDING

This function is to hold the analog output signal at the value immediately before beginning of the calibration.

On the other hand, the displayed value on the main display screen is not held.

Holding can be set for each component respectively in the dual components analyzer.

Depress [FUNC] key repeatedly until message "HoLd" is displayed on the main display screen.

The indicating light HOLD blinks and it indicates that the analyzer is operating in the function mode "Setting of analog output signal holding". Message "on" or "oFF" is displayed on the sub-display screen. (Fig. 5.5.2 a)

"on" denotes that the holding function is effective.

"oFF" denotes that the holding function is ineffective.

Depress [FUNC] key if the current setting is applicable and move to other function mode.

Follow the procedure described below when current setting is to be changed.

Depress [ > ] or [ ^ ] or [ COMP ] key.

The display on the sub-display screen blinks and it indicates that the setting is ready for change. (Fig. 5.5.2 b)

Choose the component for the dual components analyzer with [ COMP ] key.

Depress the [ ^ ] key, and select either ON or OFF.

After setting a new parameter, depress [ ENT ] key and store it into the memory.

Blink of the sub-display screen stops when the new parameter is stored.

(Fig. 5.5.2c)

When holding is set as "ON", indicating light HOLD is lit during calibration.

FUNC

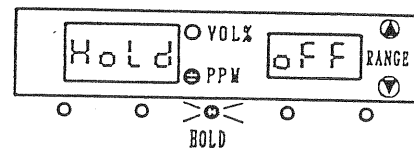

Fig. 5.5.2a

>

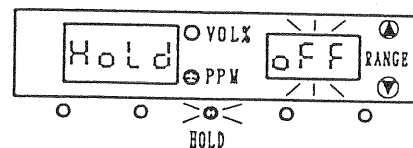

Fig. 5.5.2b

ENT

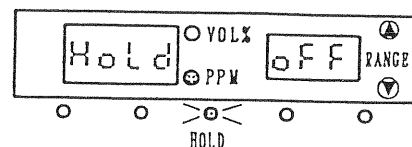

Fig. 5.5.2c

NOTE

When [ZERO] key or [SPAN] key is depressed and calibration is taking place, holding of the analog output is effective during calibration and until 30 minutes after the end of calibration.

On the other hand, in automatic calibration, holding is released after analog output signal representing measured component concentration.

Besides, notwithstanding setting of the holding function ON or OFF, the analog output signal is held while the analyzer is operating in set mode.

When a remote control signal for holding is applied, the analog output is frozen at the value when the signal is applied.

Timing charts of above described 3 cases are shown below

1) Zero or span calibration

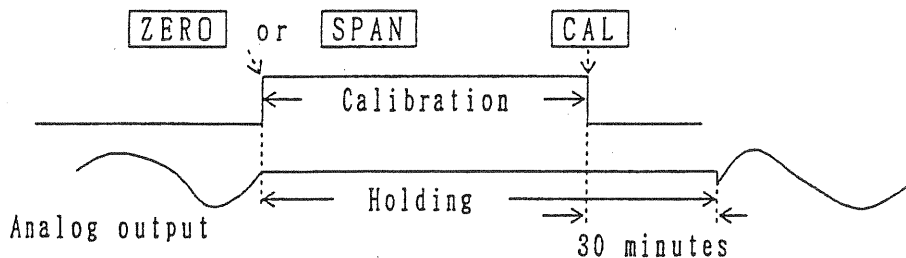

2) Automatic calibration

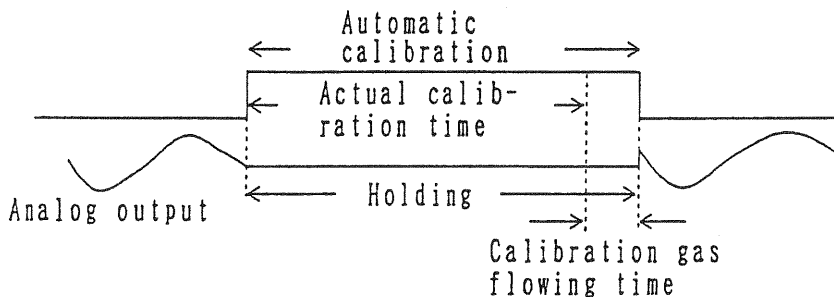

3) Remote control of analog output holding

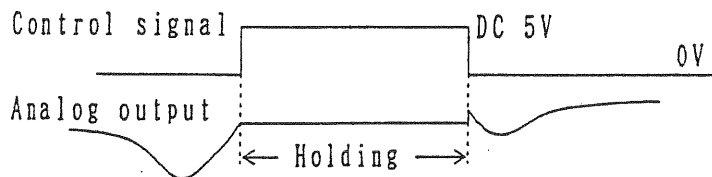

### 5.5.3 SETTING OF REMOTE RANGE(OPTION)

In this function mode, either of 2 ways for selecting measuring ranges of the dual components analyzer can be selected or reviewed. The one is to perform range selection by external signal, the other is to perform it by depressing range selection keys on the front panel of the analyzer.

Depress [FUNC] key repeatedly until message "r.rAG" appears on the main display screen. Message "on" or "oFF" appears on the sub-display screen.

The indicating light RMT RANGE blinks, and it indicates that the analyzer is operating in this function mode.

"on" denotes that measuring ranges are selectable by external signal.

"oFF" denotes that measuring ranges are selectable manually by depressing range selection keys on the front panel of the analyzer.

(Fig. 5.5.3a)

If the current setting is applicable, depress [FUNC] key and move to other function mode.

When the current setting should be changed, follow the procedure described below.

Depress [>] or [^] or [COMP] key, display on the sub-display screen blinks and it indicates that the setting is ready for change.(Fig. 5.5.3b)

By depressing [^] key, change the displayed message from "oFF" to "on" or vice versa.(Fig. 5.5.3c)

Depress [ENT] key, and store the new parameter into the memory.

After the new parameter being stored, display on the sub-display screen stops blinking.(Fig. 5.5.3d)

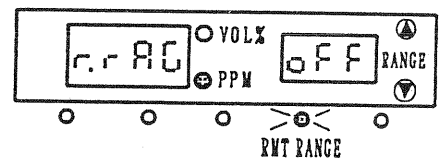

Fig.5.5.3a

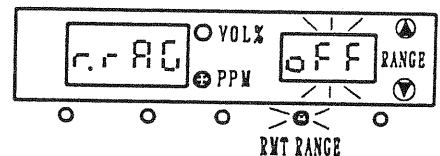
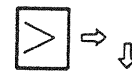

Fig.5.5.3b

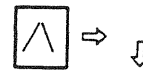
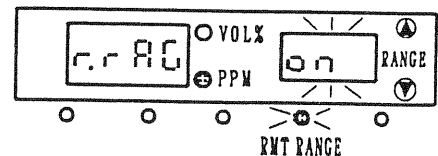

Fig.5.5.3c



RMT RANGE

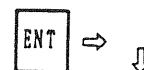
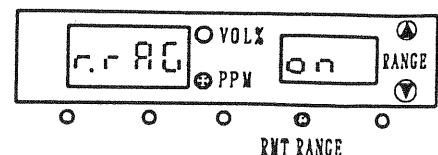

Fig.5.5.3d



RMT RANGE

#### NOTE

If "Remote range" is set as ON the indicating light RMT RANGE is lit & manual range selection is not feasible.



#### 5.5.4 KEY LOCK ON/OFF SETTING

The key lock ON/OFF function intends to protect various settings from careless alteration.

When the key lock is set as ON, all key operations except [FUNC] key becomes invalid, that is, various parameters and data can be reviewed in the state of key lock "on", but the setting cannot be changed.

Set the key lock "OFF" before setting change and manual calibration.

Depress [FUNC] key repeatedly until message "LOC" being displayed on the main display screen.

The current setting "on" or "off" is displayed on the sub-display screen.

(Fig. 5.5.4 a)

Follow the procedure described below when the setting should be changed.

Depress [ > ] or [ ^ ] or [ COMP ] key.

Display on the sub-display screen blinks and it indicates that the setting is ready for change. (Fig. 5.5.4 b)

Depress [ ^ ] key and set "on" or "off" on the sub-display screen.

(Fig. 5.5.4 c)

After setting a new parameter, depress [ ENT ] key and store it into the memory.

Blink of the sub-display screen stops when the new parameter is stored.

(Fig. 5.5.4 d)

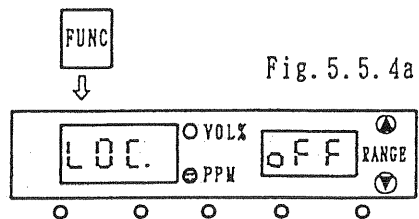

Fig. 5.5.4a

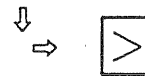

Fig. 5.5.4b

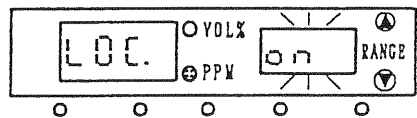
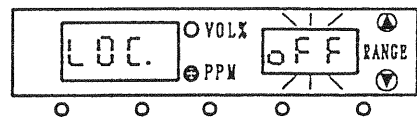

Fig. 5.5.4c

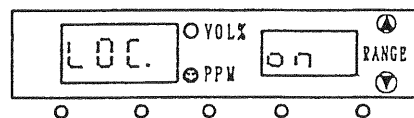

Fig. 5.5.4d

## 5.6 AUTOMATIC CALIBRATION (OPTION)

The automatic calibration is performed periodically and also performed at any time by an external start signal (remote start). When automatic calibration starts, the signal outputs for solenoid valves energizing at the automatic calibration input-output terminals turn on in preset sequence.

Zero gas and span gas are introduced into the analyzer in order and calibration of zero points and calibration of span points are automatically performed.

If the dual ranges analyzer is used, automatic calibration must be performed at the measuring range in which span gas is prepared and its concentration (span value) is set beforehand.

Automatic calibration is handled as top priority. When automatic calibration starts, all other functions are interrupted.

All key operations and an external range selection signal become invalid while the automatic calibration is taking place.

### NOTE

The automatic calibration initiated by an external signal (remotely started automatic calibration) handled with more priority than the periodic automatic calibration.

Periodic automatic calibration does not start at its starting time if the automatic calibration due to a remote start signal is being performed.

Moreover, when a remote start signal is given during periodic automatic calibration, the automatic calibration is interrupted and the automatic calibration initiated by the remote start signal starts.

Even if the setting of automatic calibration ON/OFF is OFF, automatic calibration due to remote signal can be performed.

The DC voltage signal to be given to the remote start signal input terminal should be 5V and longer than 100msec. in duration.

To decide how automatic calibration operates, the following parameters should be set properly.

- Setting of automatic calibration start timer (5.6.1)
- Setting of automatic calibration cycle time (5.6.2)
- Setting of calibration gas flowing time (5.6.3)
- Setting of calibration gas flowing mode (5.6.4)
- Setting of automatic calibration ON/OFF (5.6.5)

If an automatic calibration should be interrupted after it's starting, [ENT] key and [CAL] key must be simultaneously depressed.

The automatic calibration is discontinued and the analyzer returns to operate in the function mode "Measuring".

If an error occurs during automatic calibration, a contact signal is transmitted from the automatic calibration input-output terminal.

The corresponding error code is displayed on the sub-display screen. (Refer to P.7-13 )

The calibration is not performed for the calibration gas in which error occurs and it moves to the introduction of the following calibration gas or sample gas determined in the calibration program.

Fig.5.6.1 is a timing chart of typical automatic calibration.

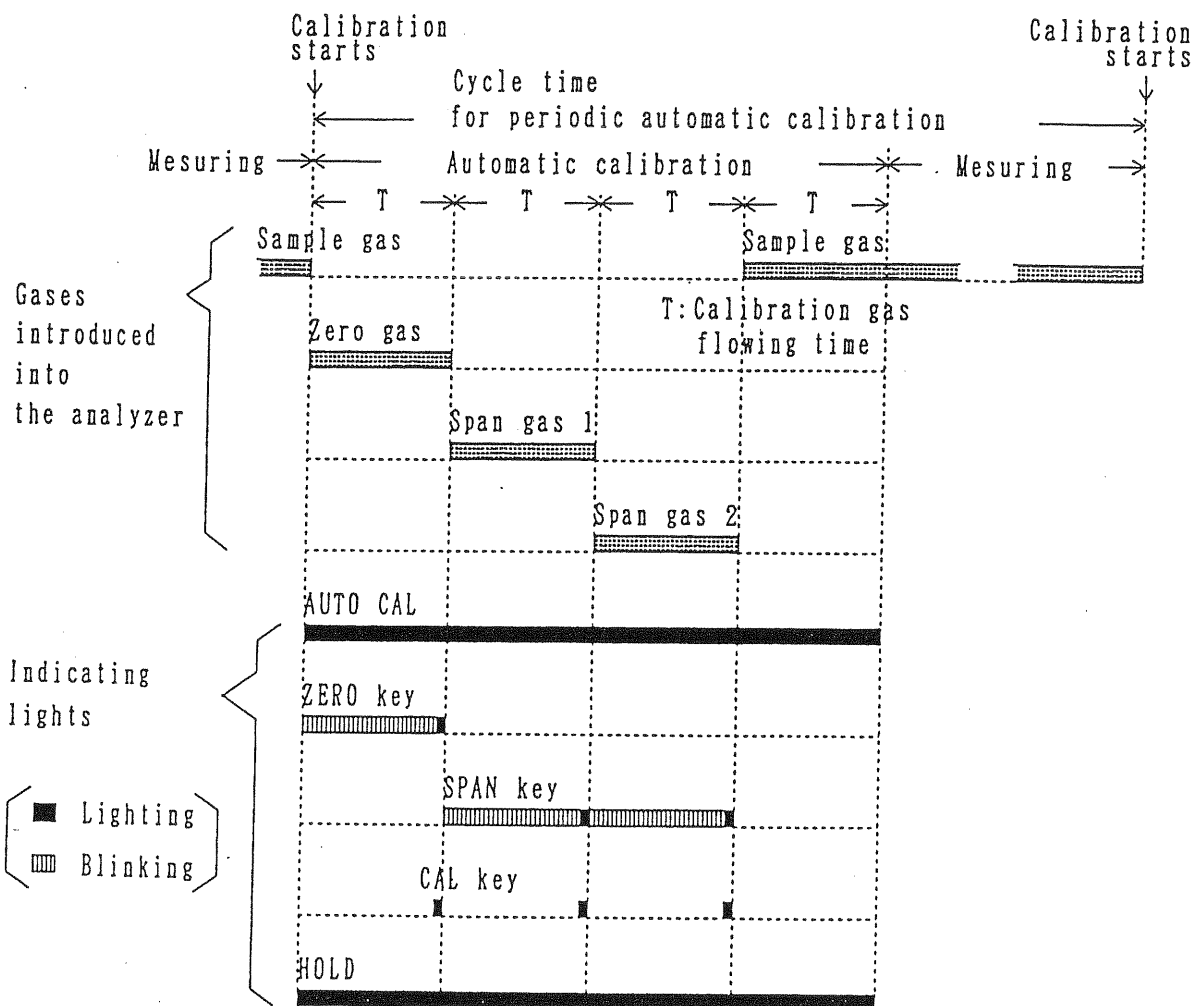

Fig.5.6.1 Timing chart of an automatic calibration

### 5.6.1 SETTING OF AUTOMATIC CALIBRATION START TIMER

The start timer sets starting time of the next periodic automatic calibration.

The next periodic automatic calibration begins after time set in the start timer elapsed.

This setting should be renewed at the new installation or if the time at which the periodic automatic calibration is performed deviates from desirable range because of interruption of power supply etc.

Depress [FUNC] key repeatedly until message "Strt" appears on the main display screen. The indicating light AUTO CAL blinks and the time until the next periodic automatic calibration is displayed on the sub-display screen in counting down mode.(Fig.5.6.2a)

If the current setting is applicable, depress [FUNC] key and move to other function mode.

When the start time should be changed, follow the procedure described below.

Depress [>] or [^] or [COMP] key.

The display on the sub-display screen blinks and it indicates that the setting is ready for change.(Fig.5.6.2b)

The first digit below decimal point means time in 10 minutes.

Numbers upper than decimal point mean time in hours.

Depress [>] key and choose the digit to be changed.

The display of the chosen digit blinks.

Depress [^] key and change the number.

The time can be set from 10 minutes to 199 hours in 10 minutes step.

After setting, depress [ENT] key and store the new start time into the memory.

Time until the next periodic automatic calibration is displayed in counting down mode on the sub-display screen after [ENT] key depressed.(Fig.5.6.2c)

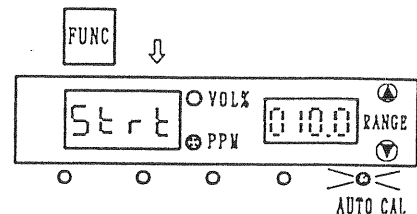

Fig. 5.6.2a

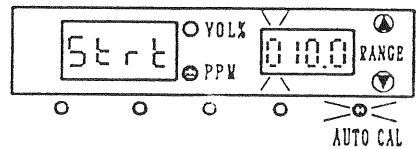

Fig. 5.6.2b

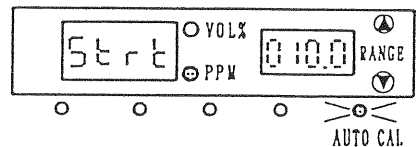
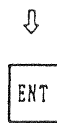

Fig. 5.6.2c

NOTE

Time until the next periodic automatic calibration is displayed on the sub-display screen either the setting of automatic calibration ON/OFF is ON or OFF.  
 But, the periodic automatic calibration is not performed if the automatic calibration ON/OFF is set as OFF .

### 5.6.2 SETTING OF AUTOMATIC CALIBRATION CYCLE TIME

In this function mode, The time interval that the periodic automatic calibration is performed is reviewed or set.

The time interval can be set 1 to 199 hours in one hour step.

Depress [FUNC] key repeatedly until message "CyCL" appears on the main display screen.

The indicating light AUTO CAL blinks.

The automatic calibration cycle time currently set is displayed on the sub-display screen.(Fig.5.6.3a)

Depress [FUNC] key and move to other function mode if the current setting is applicable.

If the setting value should be changed, follow the procedure described below.

Depress [ > ] or [ ^ ] or [ COMP ] key.

The most significant digit on the sub-display screen blinks. It indicates that the setting is ready for change.

(Fig.5.6.3b)

Choose the digit to be changed by depressing [ > ] key. The display of the chosen digit blinks

Depressing [ ^ ] key, the digit chosen increases one by one.(Fig.5.6.3c)

After setting, Depress [ ENT ] key and store the new cycle time into the memory.(Fig.5.6.3d)

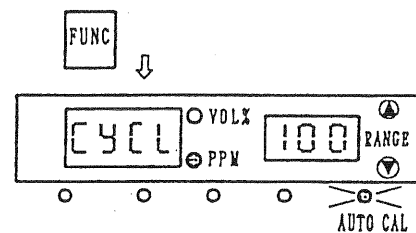

Fig. 5.6.3a

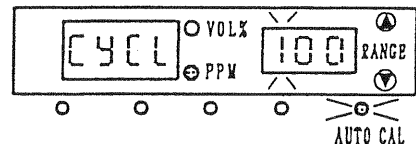

Fig. 5.6.3b

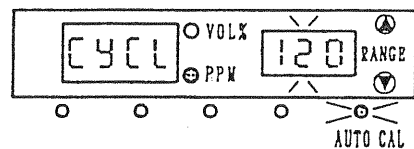
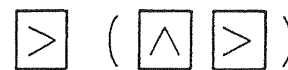

Fig. 5.6.3c

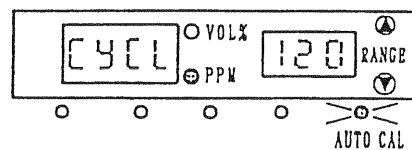
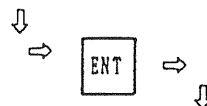

Fig. 5.6.3d

### 5.6.3 SETTING OF REFERENCE GAS FLOWING TIME

The gas flowing time should cover the time necessary for complete substitution of gas inside the analyzer from sample gas to calibration gas or vice versa and the concentration reading reaching to it's final value.

The time can be set from 100 to 599 seconds in one second step.

Depress [FUNC] key repeatedly until message "F.SEC" appears on the main display screen.

The indicating light AUTO CAL blinks, and the calibration gas flowing time currently set is displayed on the sub-display screen. (Fig.5.6.4a)

If the current setting is applicable, depress [FUNC] key and move to other function mode.

If it is to be changed, depress [ > ] or [ ^ ] or [ COMP ] key, the analyzer becomes the state that the setting is ready for change.

Depress [ > ] key to choose the digit to be changed. The display of the chosen digit blinks.

Depress [ ^ ] key and change the digit. (Fig.5.6.4b)

After setting, store the new calibration gas flowing time by depressing [ ENT ] key. (Fig.5.6.4c)

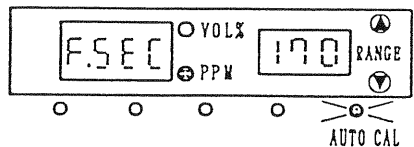
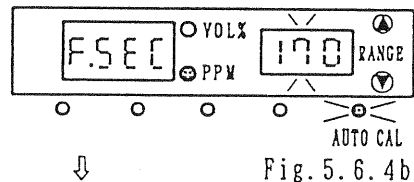
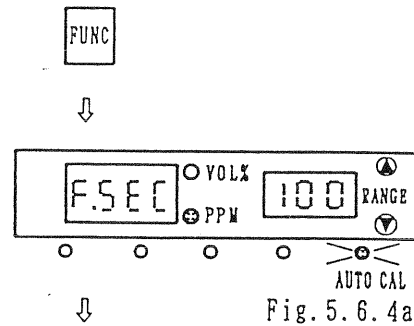

### 5.6.4 SETTING OF CALIBRATION GAS FLOWING MODE

In this function mode the calibration gases to be introduced into the analyzer and their order of introduction are set.

Depress [FUNC] key repeatedly until message "FLno." appears on the main display screen.

The indicating light AUTO CAL blinks. The number from 0 to 3 which indicates the flowing mode currently set is displayed on the sub-display screen.

(Fig.5.6.5a)

These numbers correspond to flowing modes as follows.

No.0:Zero gas

No.1:Zero gas-The span gas for the first component

No.2:Zero gas-The span gas for the second component

No.3:Zero gas-The span gas for the first component-the span gas for the second component

FUNC

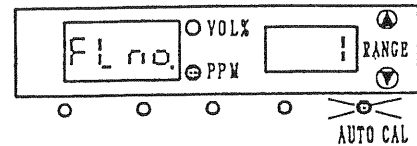

Fig. 5.6.5a



[>] ( [^] )

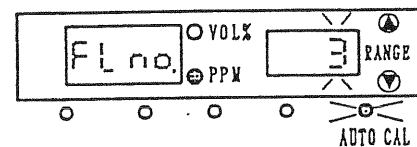

Fig. 5.6.5b

#### NOTE

Choose mode number 1 when zero and span automatic calibration is to be performed in single components analyzer.

Depress [FUNC] key and move to other function mode, if the current setting is applicable.

If setting should be changed, follow the procedure described below.

Depress [>] or [^] or [COMP] key, the analyzer becomes the state that the setting is ready for change.

Depress [^] key and change the mode number.(Fig.5.6.5b)

Store the new mode number by depressing [ENT] key.(Fig.5.6.5c).



ENT

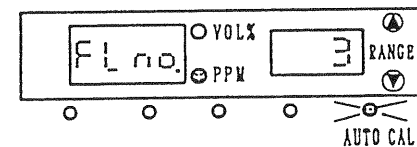

Fig. 5.6.5c

### 5.6.5 SETTING OF AUTOMATIC CALIBRATION ON/OFF

This setting is to choose either the periodic automatic calibration is performed or not.

When periodic automatic calibration is to be performed, it should be set as ON and when not, it should be set as OFF.

Periodic automatic calibration is not performed if it is set as OFF. However, the remote start automatic calibration is possible in spite of setting as OFF.

Depress [FUNC] key repeatedly until message "A.CAL" appears on the main display screen.

The indicating light AUTO CAL blinks and "on" or "off" currently set is displayed on the sub-display screen. (Fig.5.6.6a)

Depress [FUNC] key and move to other function mode if the current setting is applicable.

Follow the procedure described below if the current setting should be changed.

Message "on" or "off" on the sub-display screen blinks when [ > ] or [ ^ ] or [ COMP ] key is depressed and it indicates that the setting is ready for change. (Fig.5.6.6b)

(Fig.5.6.6b)

Depress [ ^ ] key and change the setting (Fig.5.6.6c)

Depress [ ENT ] key and store the new setting. (Fig.5.6.6d)

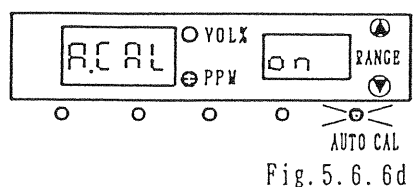
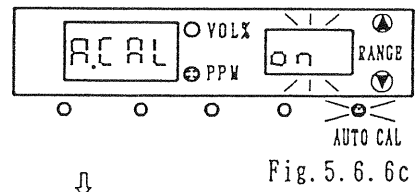
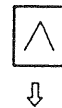
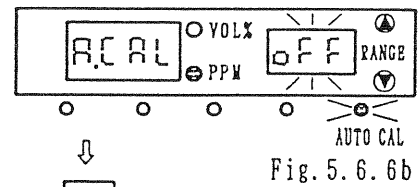
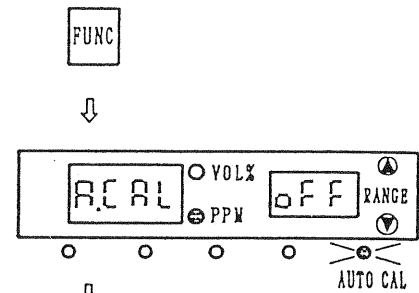



## 6. MAINTENANCE

### WARNINGS

- Dangerous voltages are present inside the instrument assembly.
- Be careful with the gas leakage, especially in case of toxic gas.

To ensure normal operation of analyzer, carry out daily, weekly and yearly checks & maintenance according to the following table.

#### Points of daily check

Check points	Troubles	Causes	Adjustments
Digital display of concentration	Large indicating error	1) Dust is contained in measuring cell	1) Clean the cell. Check sampling systems, especially gas filter.
		2) Leaking of air into sampling piping.	2) Find leaking part & repair.
Flow rate of sample gas & purge gas (in case of interior purging)	Deviating from allowable range 0.5~1.5 ℓ /min.		Adjust flow rate.
Dust filter (membrane filter)	Severe contamination	Breakage of primary filter etc.	1) Replace primary filter. 2) Replace membrane filter.

### Points of weekly check

Analyzer zero point	Zero shift		Carry out calibration of zero point
Analyzer span point	Span shift		Carry out calibration of span point

### Point of yearly check

Analyzer		Preventive maintenance	Overhaul analyzer
----------	--	------------------------	-------------------

## 6.1 MEASURING CELL CLEANING

When measuring cell inside is contaminated by dust or mist, a drift of measured value may be caused.

Clean the interior of the measuring cell if contaminated. At the same time, check sampling system devices, especially filter, in order to eliminate any cause of contamination of cell interior by dust & mist.

### 6.1.1 HOW TO DISASSEMBLE AND REASSEMBLE MEASURING CELL

There are 2 types of measuring cell, one is a block cell (cell lengths: 4mm, 8mm, 16mm & 32mm) and the other is a pipe cell (cell lengths: 64mm, 125mm & 250mm). In case of a dual components analyzer, there is a combination cell type, which is composed of both types of cells in the optical system. For this type, disassemble pipe cell first then the block cell. (refer to Fig. 6.3)

(1) How to disassemble pipe cell (refer to Fig. 6.1)

- a. Shut sample gas flow down. When toxic gas is contained, purge measuring cell interior with zero gas sufficiently.
- b. Turn power switch off.
- c. Loosen 2 fixing screws of the front panel and draw out the inner part until stopped by stoppers inside the case. When complete drawing-out of the inner part from the case is needed, hold the front panel up and draw it out beyond stop carefully.
- d. Detach piping connection to the measuring cell.
- e. Displace the infrared source unit (No. 5 in Fig. 6.1) by loosening

- 2 fixing screws(No.1 in Fig. 6.1) to base plate so as to make a gap between pipe cell(No.12 in Fig.6.1) and IR source unit.
- f. Loosen and detach 4 screws(No.7 in Fig.6.1) of the cell holders (No.11 in Fig. 6.1).
  - g. Remove the cell from measuring unit then detach both windows (No.14 Fig. 6.1) by rotating the window holders anticlockwise.
  - h. A window plate made of calcium-fluoride is fixed to the window holder and reflector plate inside cell is fixed to cell wall, therefore both are unremovable.
  - i. Proceed reassembling in reverse to disassembling procedures. In reassembly, make a space of approx. 0.5 mm both between infra-red source unit & cell and between cell & detector.

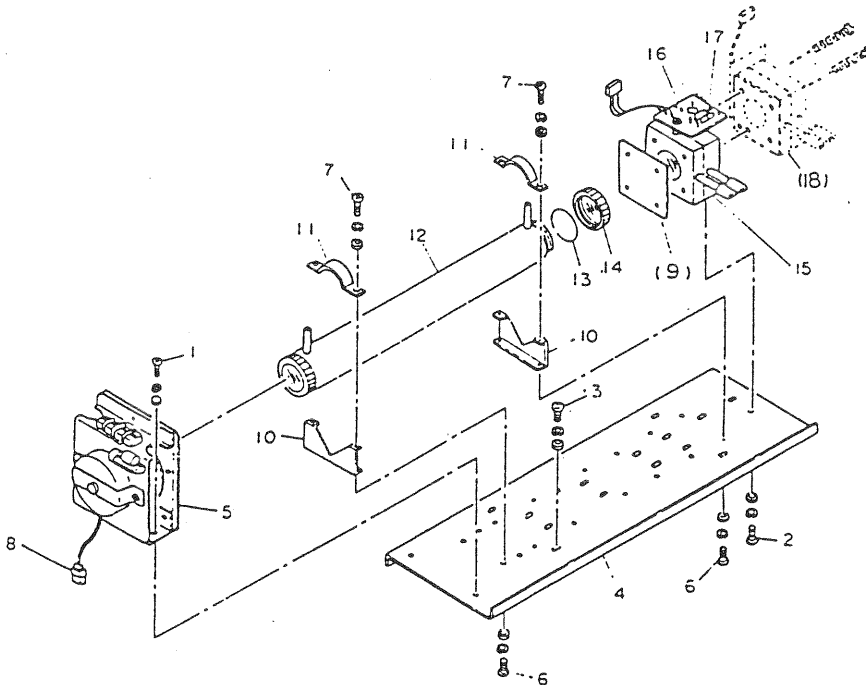

Fig. 6.1 Exploded view of measuring unit  
(Pipe cell)

- |   |                                      |
|---|--------------------------------------|
| 1. Screw(for infrared source unit fixing) | 10. Support                          |
| 2. Screw(for detector fixing)             | 11. Holder                           |
| 3. Screw(for base plate fixing)           | 12. Pipe cell                        |
| 4. Base plate                             | 13. O-ring                           |
| 5. Infrared source unit                   | 14. Window                           |
| 6. Screw(for support fixing)              | 15. Detector                         |
| 7. Screw(for holder fixing)               | 16. Bridge cct. board                |
| 8. Connector for chopper motor            | 17. Bridge resistor                  |
| 9. [Filter(provided if necessary)]        | 18. [Detector for the 2nd component] |

- (2) How to disassemble block cell(refer to Fig.6.2 next page)
- a. Proceed the same procedures described in a.~d. of (1)how to disassemble pipe cell.
  - e. Remove connector a of detector output cord from p.c.b..  
In case of the dual components analyzer, remove connector of output cord of the 2nd component detector(No.13 in Fig.6.2) from the 2nd component printed cct. board, then remove the 2nd component detector by loosening 2 screws(No.14 in Fig.6.2).
  - f. Loosen 2 screws(No.10 in Fig.6.2), with which the detector and the infrared source unit are mounted together, then remove the detector from the measuring unit.  
In this removal, the cell is also removed together with detector.
  - g. Remove the cell from the detector by loosening 2 fixing screws (No.6 in Fig.6.2).  
A window(No.8 in Fig.6.2) on one side of block cell is not fixed but only inserted between detector and block cell, therefore hold the detector upside while disassembling not so as to drop the window down.
  - h. Proceed reassembling in reverse to disassembling procedures.  
Locate an O-ring between the window holder and detector.  
Be sure not to mislocate the O-ring.  
For the dual components analyzer, the 2nd component detector should be assembled after finishing assemble of the 1st component detector.  
Make sure not to make space between 1st and 2nd detectors.  
Also, make sure that 2 connectors of detector output cord are connected properly to the 1st and 2nd component printed cct. boards.

CAUTION

The window on one side of block cell is not fixed. Be careful not to break it by careless falling down.(Refer to (2)g)

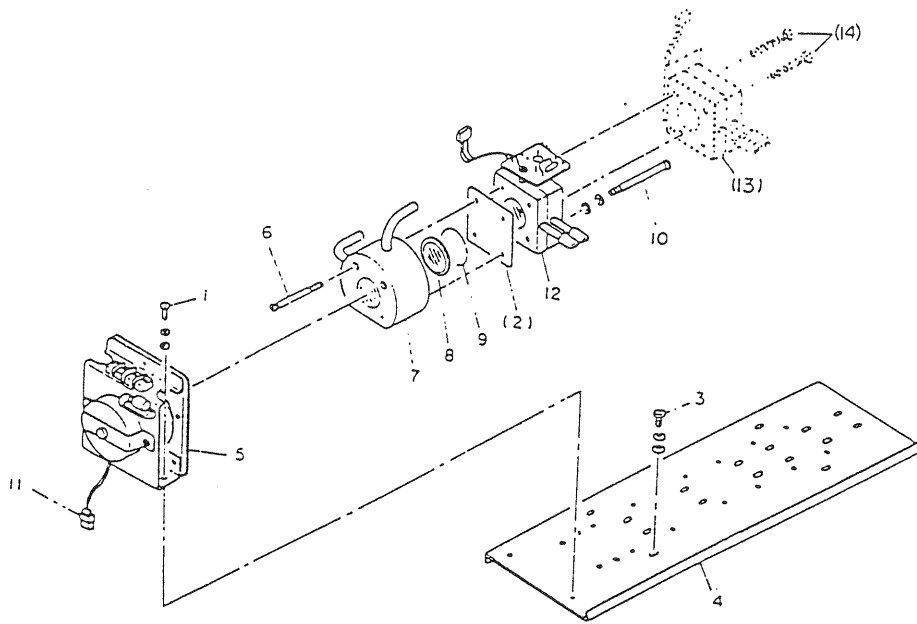

Fig. 6.2 Exploded view of measuring unit  
(Block cell)

- |   |   |
|---|---|
| 1. Screw(for infrared source unit fixing) | 8. Window   |
| 2. [Filter(provided if necessary)]        | 9. O-ring   |
| 3. Screw(for base plate fixing)           | 10. Screw(for detector fixing)                        |
| 4. Base plate                             | 11. Connector of chopper motor                        |
| 5. Infrared source unit                   | 12. Detector  |
| 6. Screw(for block cell fixing)           | 13. [Detector for the 2nd component]                  |
| 7. Block cell                             | 14. [Screw(for the 2nd component<br>detector fixing)] |

- (3) How to disassemble combination cell: (Refer to Fig.6.3 next page)
- a. Proceed the same procedures described in a.~d. of (1) how to disassemble pipe cell.
  - e. Remove connectors of output cord of detector from printed cct. boards.
  - f. Remove both wiring to 2 pin terminals of the infrared source unit and 2 pin connectors(No.19 in Fig.6.3) of the chopper motor.
  - g. Remove 4 screws(No.20 in Fig.6-3) for fixing the base plate(No.3 in Fig.6.3) and take out the measuring unit.

## CAUTIONS

- Do not give any rough handling to both pipings of detector and infrared source unit during disassembling & reassembling measuring cell. Pipe deforming may lead to irregular action due to leakage of sealed gas.
- Window(No.7 in Fig.6-3) on one side of block cell is not fixed, therefore, care not to break it by falling down.

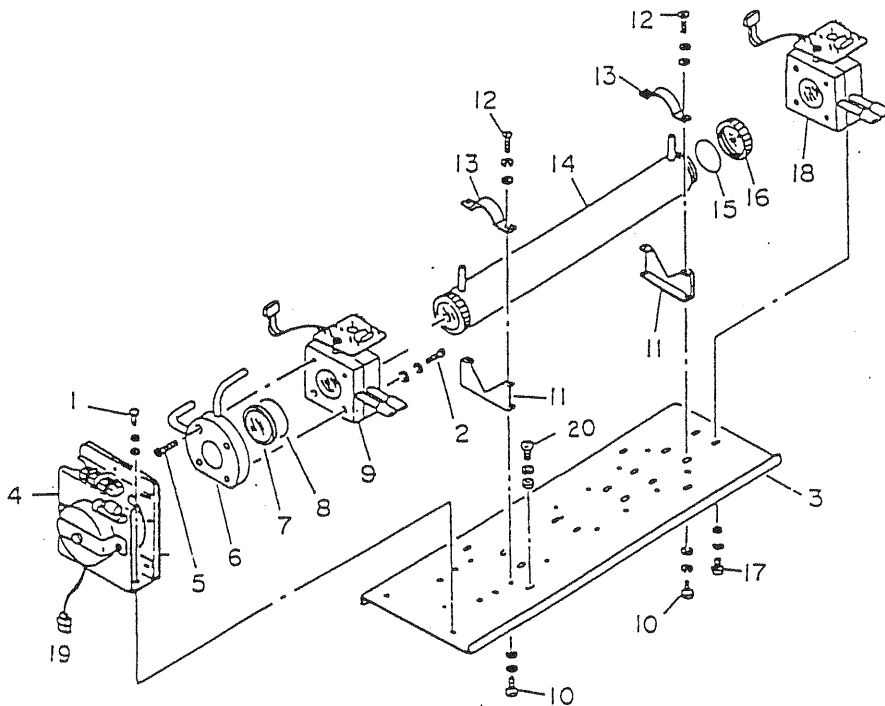

Fig.6.3 Exploded view of measuring unit  
(Combination cell)

- |                                      |                                  |
|--------------------------------------|----------------------------------|
| 1. Screw(for infrared source fixing) | 11. Support                      |
| 2. Screw(for detector fixing)        | 12. Screw(for holder fixing)     |
| 3. Base plate                        | 13. Holder                       |
| 4. Infrared source unit              | 14. Pipe cell                    |
| 5. Screw(for block cell fixing)      | 15. O-ring                       |
| 6. Block cell                        | 16. Window                       |
| 7. Window                            | 17. Screw(for detector fixing)   |
| 8. O-ring                            | 18. Detector                     |
| 9. Detector                          | 19. Connector of chopper motor   |
| 10. Screw(for support fixing)        | 20. Screw(for base plate fixing) |

## 6.1.2 HOW TO CLEAN CELL

### CAUTIONS

- Be careful to handle cell windows as it is very fragile and easily scratched on surface.
- Be careful not to make scratch or crack on cell interior because it is utilized as optical reflection mirror face.

- (1) At cleaning of cell inside and infrared ray window, firstly wipe out with soft brush etc. for rather big particles of dust, then with soft cloth lightly.  
Do not use hard cloth for cleaning.
- (2) In case of a heavily dirty window, clean it with alcohol or acetone moistened soft cloth.
- (3) If a window were lightly corroded, remove corrosion by rubbing with chromium oxide powder on soft cloth.  
However, if heavily corroded, replace it with a new one.
- (4) After cleaning of cell and window, reassemble them according to disassembling & reassembling procedures of cell.  
Connect piping tightly so as not to leak during operation.  
Also, be sure to connect piping rightly without forced bent portion.

## 7. TROUBLE-SHOOTING

### WARNINGS

- Dangerous voltages are present inside the analyzer.
- Be careful for gas leakage, especially for toxic gas.

### 7.1 TROUBLE-SHOOTING

Proceed trouble shootings according to flow-charts in this paragraph and referring to Fig.7.1 on page 7-6.

#### 7.1.1 DISPLAY OR INDICATING LIGHTS ARE NOT LIT ON

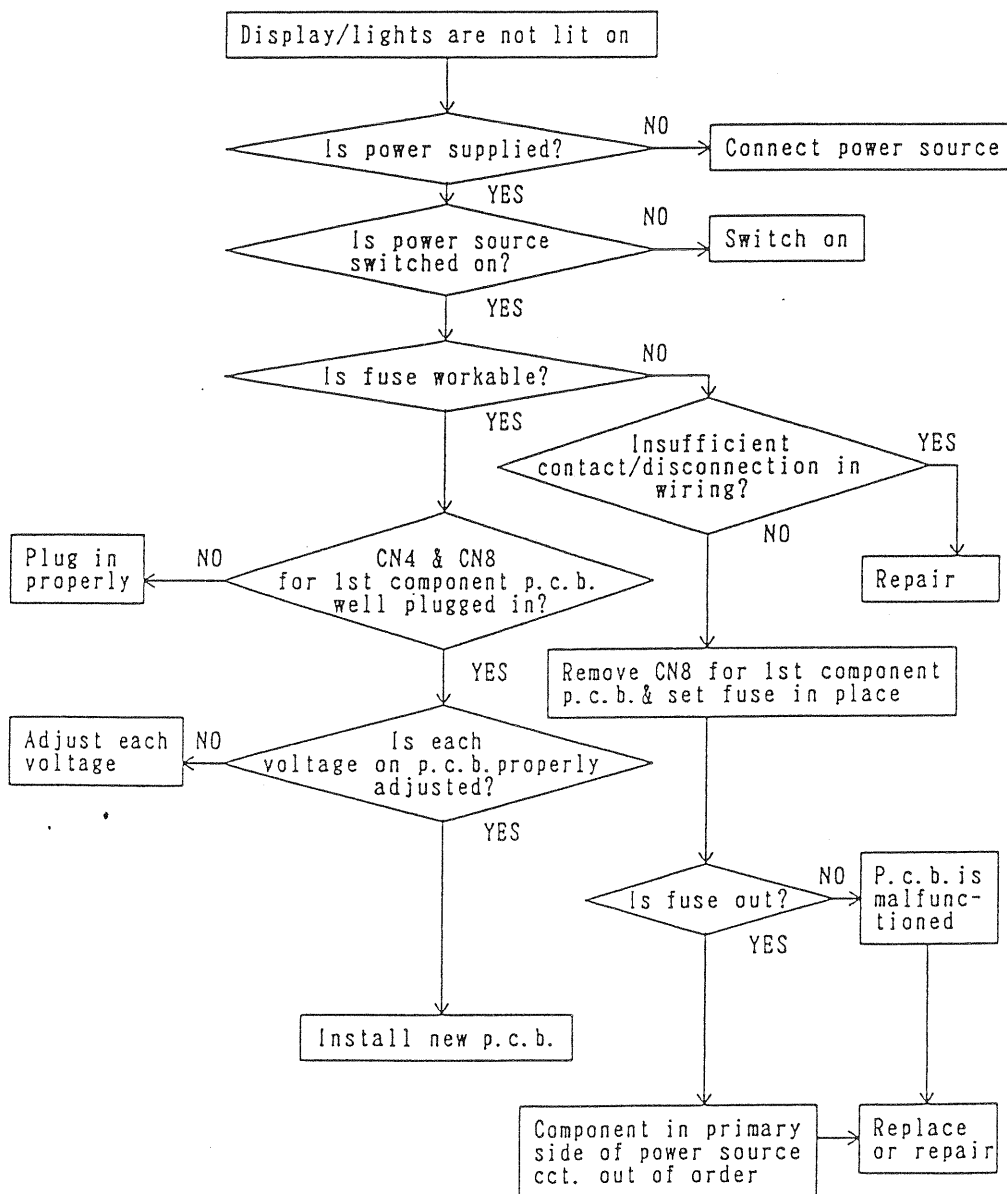



### 7.1.2 INDICATED VALUE IS NOT VARIED

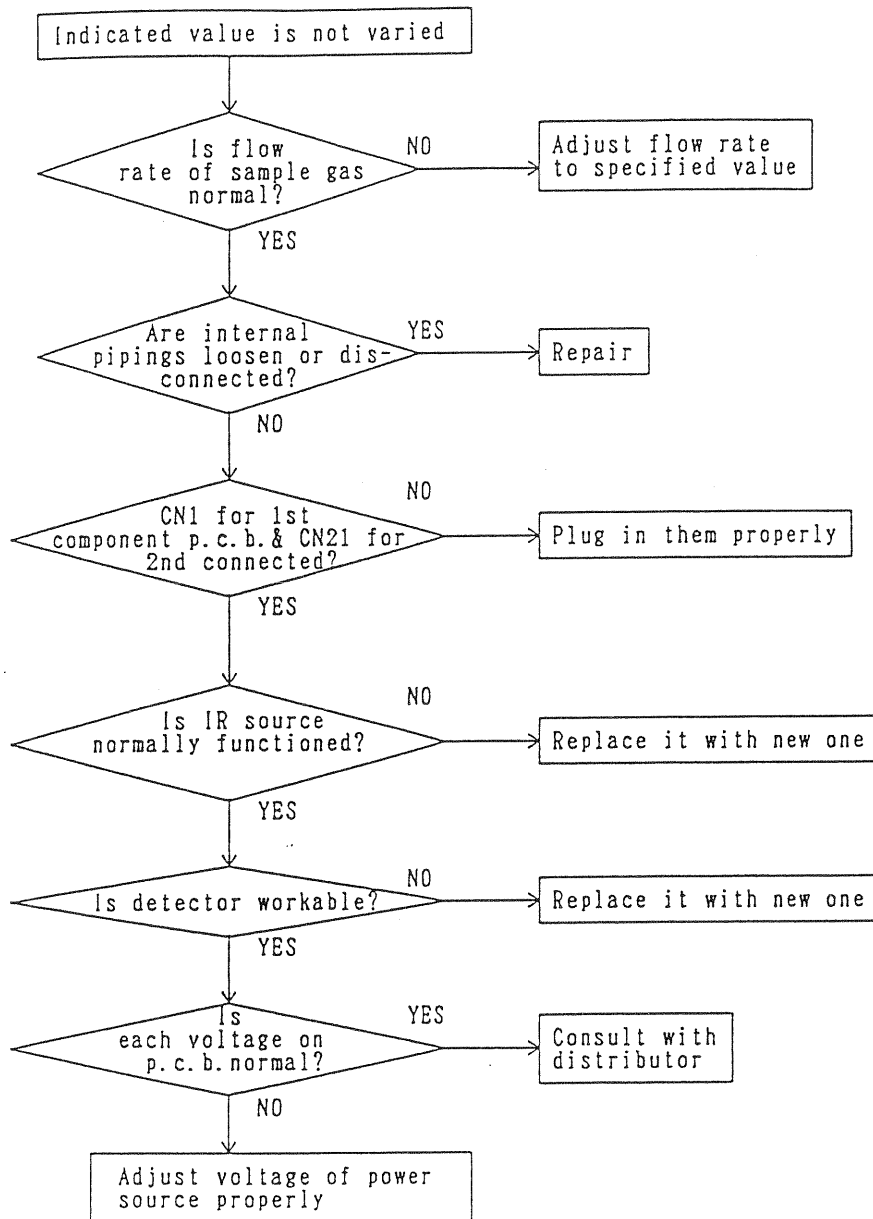

### 7.1.3 INDICATED VALUE IS NOT STABILIZED

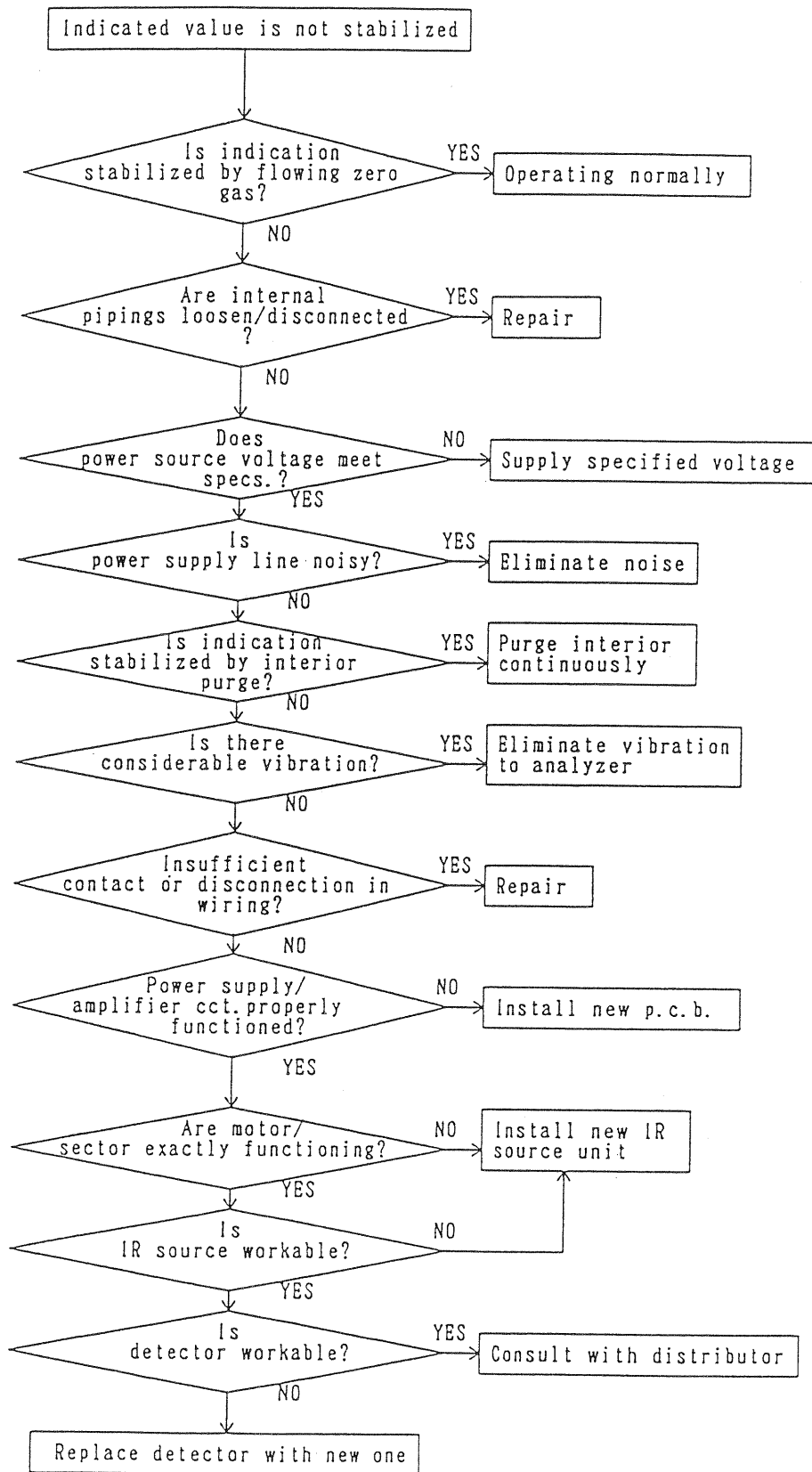

#### 7.1.4 RESPONSE IS SLOW

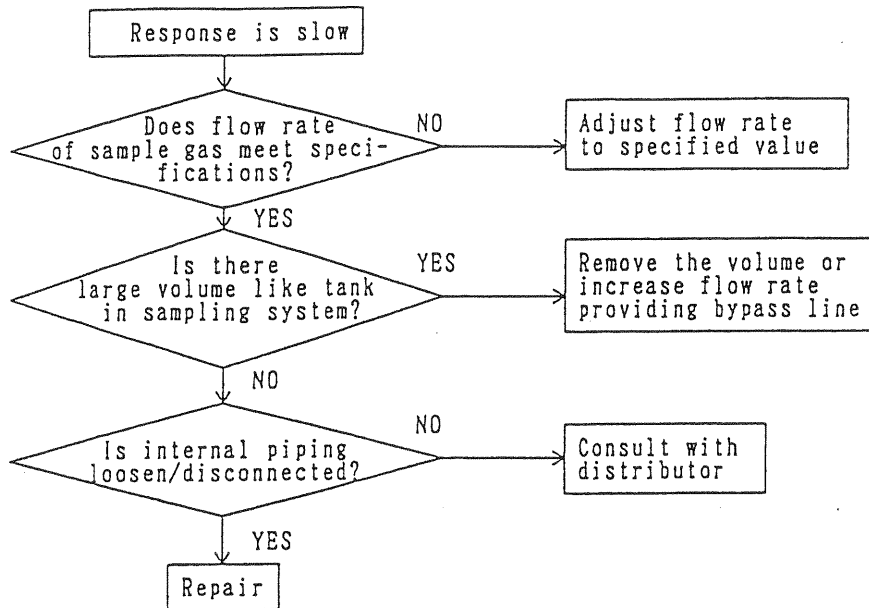

#### 7.1.5 RESPONSE IS SLOW AT RETURNING TO ZERO

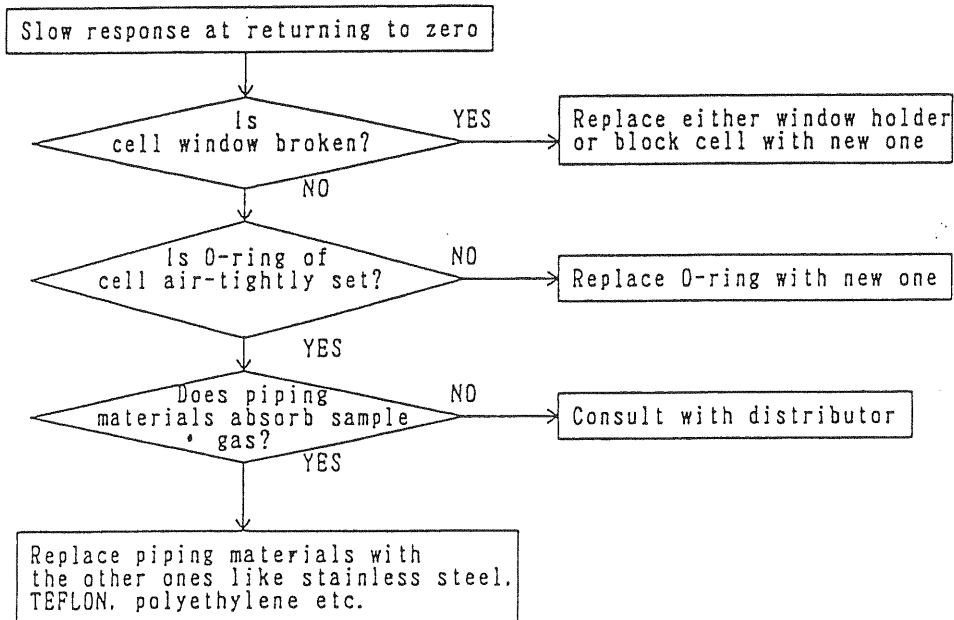

NOTE: TEFLON is a registered trade name of DuPont Inc.

### 7.1.6 LARGE DRIFT

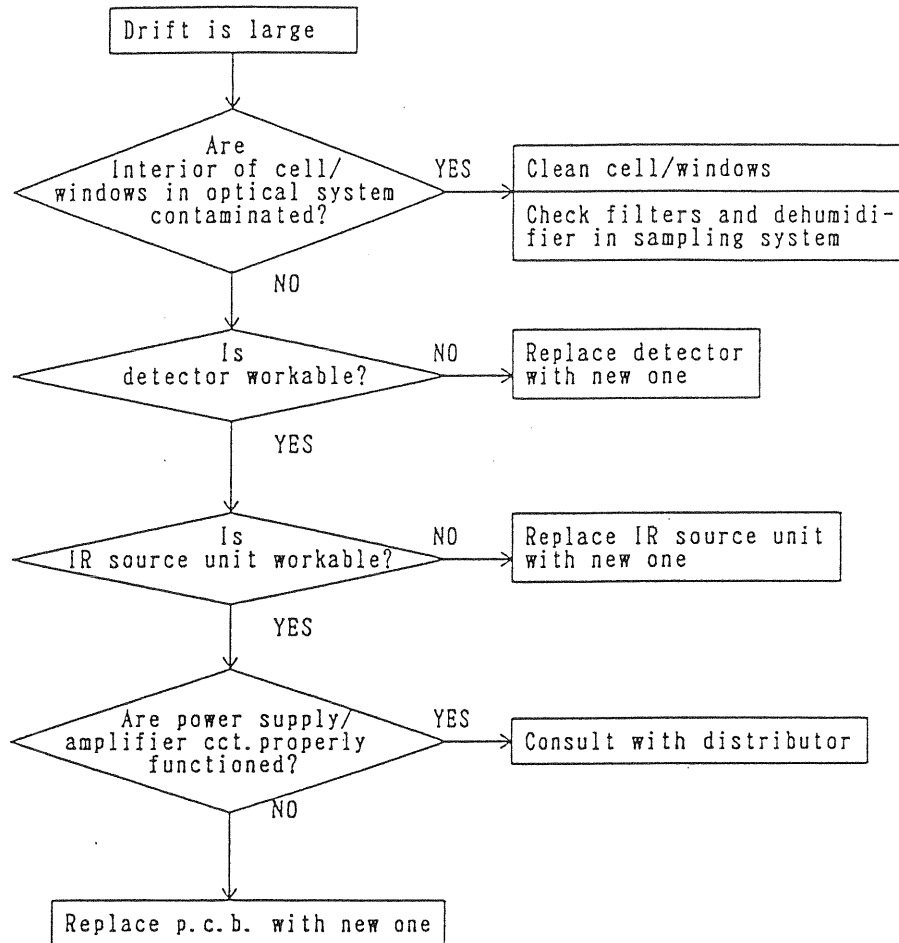

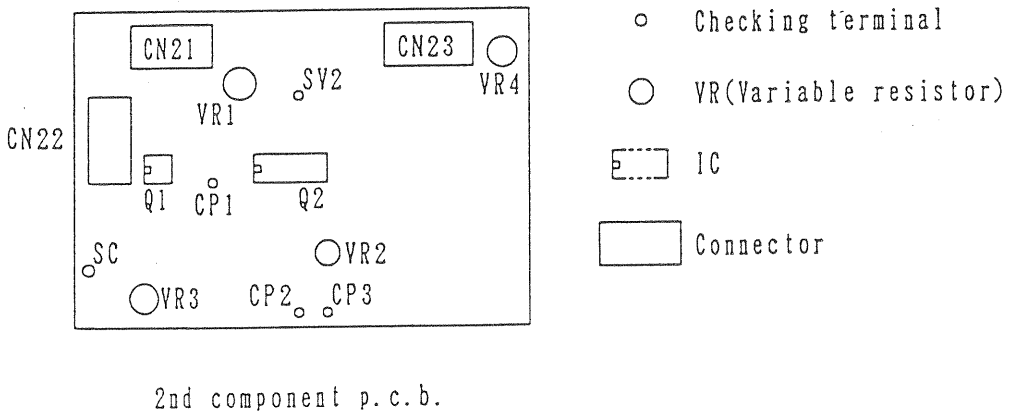
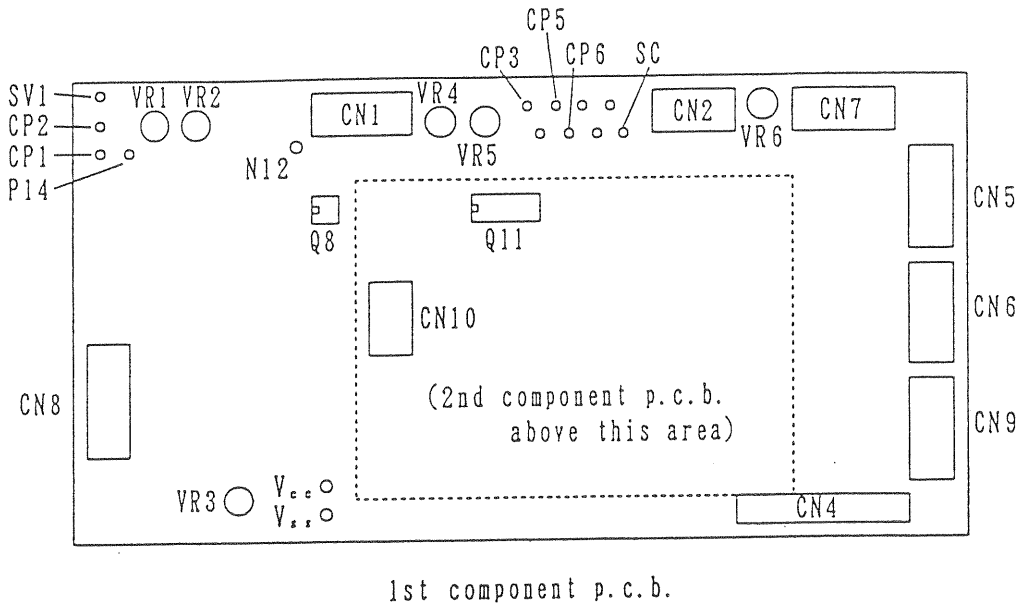

Fig. 7.1 Parts lay out on p.c.bs.

## 7.2 CHECKING AND REPAIRING

### 7.2.1 DETECTOR(No.15 IN FIG. 6-1)

Symptom: Zero adjustment not feasible

Causes of trouble: Breakage of mass-flow sensor or  
trouble of bridge resistances or  
leakage of detector sealed gas.

- Checking:
- a) There are approx. 1.5V~2V DC voltages on between 1 & 3 and 2 & 3 terminals of bridge p.c.b. of detector (No.16 in Fig.6-1) and when the differences between both voltages are within 0.1V, the mass-flow sensor and bridge resistors (No.17 in Fig.6.1) operate properly.
  - b) Connect a synchroscope between CP6 & SC check terminals on the 1st component p.c.b..  
When AC waveform(8<sup>+</sup>/, or 10 HZ) at the check terminals is not observed although checking a) above is passed and the IR source unit & chopper operate properly, leakage of detector sealed gas is most probable.(Refer to 7.2.6(2))  
Regarding checking of the 2nd component, proceed checking between CP2 & SC check terminals of the 2nd component p.c.b.. Checking procedures are the same with those of the 1st component.
  - c) When measured voltages are abnormal in checking a), switch off power source and remove both connector of detector & bridge resistors, then check resistance of mass-flow sensor.  
Measure resistance value both between 1 & 3 and 2 & 3 terminals on bridge p.c.b.. When measured resistance ranges between 25 to 50  $\Omega$ , mass-flow sensor is in normal condition and bridge resistor may be damaged.  
If resistance values are infinite, mass-flow sensor is broken.

#### Replacement

- of detector:
- a) Replace detector with a new one by referring to 6.1.  
In case of pipe cell, replace the detector after removal of the measuring unit because it is fixed by screws on the under side of the base plate.

- b) After replacing the detector, adjust voltage between SV1 & SC terminals on the 1st component p.c.b. to specified detector voltage through VR2, and for the 2nd component, adjust voltage between SV2 & SC on the 2nd component p.c.b. through VR1 in the same manner as the 1st component.
- c) Proceed both zero & span adjustment.

### 7.2.2 INFRARED SOURCE UNIT(No.1 IN FIG.6.1)

Symptom: Indicated value exceeds it's range value or output signal is unstable.

Causes of trouble: Breakage of infrared source and/or leakage of infrared source unit sealed gas.

Checking:a) Switch off power source and measure resistance between 2-pin terminals after removal of lead wires from 2-pin terminal block. The normal resistance value is  $37 \pm 3 \Omega$ . When infrared source is broken, the resistance value is extremely high.

Increase of resistance make output drift towards plus side.

- b) Although both detector & amplifier p.c.b. are properly operating, if IR source unit sealed gas leaks, atmosphere may influence the output signal to drift. Keep in mind, however, that atmospheric CO<sub>2</sub> existing in air gaps of the measuring unit may cause the output signal of low-concentration CO<sub>2</sub> analyzer to drift. in this case interior purge of the analyzer is the right solution.

Replacement:a) Remove both wiring of 2-pin terminals and disconnect of the unit motor connector and then remove 2 fixing screws of the infrared source unit to base plate.

Carry out replacement by referring to Fig.6.1 or Fig.6.2..

- b) After replacement, carry out both zero & span adjustment.

### 7.2.3 CHOPPER

Symptom: Unstable output signal and/or indicated value exceeds it's range value

Cause of trouble: Irregular rotation

- Checking:
- a) Listen to note if a hitting noise of chopper blade on other components occurs when the power is switched on. If the hitting noise is emitted, take out the infrared source unit and remove the enclosure. Then adjust position of the chopper blade carefully so as not to touch other components. Be sure not to damage the chopper blade because it is made of very thin plate. If the analyzer is operating properly, do not make any adjustment on the chopper blade.
  - b) In case the motor does not start in spite of the power being switched on, disconnect motor power supply cord and check whether the specified power source voltage is supplied. When the motor does not rotate despite the right power source voltage supplied, check if the motor shaft or other motor parts might be touching other components. If the motor does not rotate even without any touching, the motor is out of order.

Replacement: Replace the whole infrared source unit with motor assembly with a new one.

Refer to 7.2.2

### 7.2.4 WINDOWS OF MEASURING CELL, DETECTOR & INFRARED SOURCE UNIT

Symptom: Zero adjustment is not feasible because of excess plus-sided drift.

Causes of trouble: Cell & windows are heavily contaminated.

Checking: After removing the cell, check whether cell and all windows are contaminated or not.

When contaminated, clean them by wiping with alcohol moistened soft cloth.



Be sure to handle windows carefully because they are easily damaged. Refer details to 6.2.

### 7.2.5 PIPING

Symptom: Unstable output signal and/or slow response

Causes of trouble: Loosening, disconnecting, contaminating & clogging

Checking: a) Proceed tight and firm repiping when piping is loosen or disconnected.

b) When inside piping is contaminated or clogged, remove contaminant inside then blow out them with compressed air.

### 7.2.6 PRINTED CCT. BOARD OF THE 1ST COMPONENT

Replacement of printed cct. board of the 1st component is needed when it is judged to be not functional through the following checkings.

#### (1) Power supply circuits

Checking: a) Secondary voltage of transformer

The output voltages of secondary windings of transformer are approx.AC 18V, approx.AC 17V, approx.AC 8V and approx.AC 100V respectively.

b) Positive 14V power supply voltage

Proceed checking using P14 & SC check terminals.

The right voltage is DC  $14V \pm 0.05V$ .

(Adjustable through VR1. However, be much careful not to exceed the specified voltage.)

c) Positive 5V power supply voltage

Proceed checking using V<sub>+</sub> & V<sub>-</sub> check terminals.

The right voltage is DC  $5V \pm 0.1V$ .

(Adjust the voltage with VR3.)

d) Negative 12V power supply voltage

Proceed checking using N12 & SC check terminals.

The right voltage is DC  $-12V \pm 1V$ .

e) Negative 5V power supply voltage

Proceed checking using CP1 & SC check terminals.

The right voltage is DC  $-5V \pm 0.5V$ .

f) Detector voltage

Check the voltage using SV1 & SC check terminals.  
The right voltage is written on the detector body.  
(Adjust the voltage with VR2.)

(2) Amplifier circuits

Check amplifier cct. after making sure that the power supply circuits function properly.

Checking: AC amplifier circuits

- a) Check AC waveform with a synchroscope connected between CP6 & SC check terminals.  
Amplitude of waveform is adjusted to be approx.  $3.5 \pm 1V_{p-p}$  by VR4 while zero gas introduced.

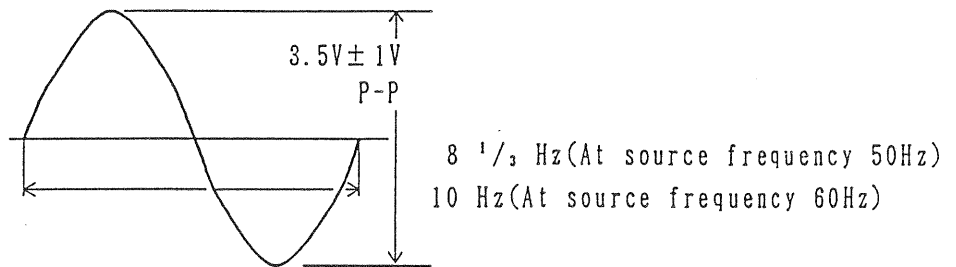

- b) In case when AC waveform can not be observed in a) above, check AC wave form between CP5 & SC check terminals. When  $8 \frac{1}{3}$  or 10 Hz AC waveform is observed, AC amplifier Q8 operates properly, and in this case, Q11 amplifier or VR4 is defective.
- c) In case when AC waveform is not observed on CP5 and SC check terminals, check the detector according to 7.2.1.

(3) Rectifying circuits

Checking: a) Check voltage to be approx. DC  $2.3 \pm 0.2V$  between CP3 & SC checking terminals with volt meter while zero gas being introduced.

- b) In case when the voltage are much different from above described value, Q11 is defective.

## 7.2.7 PRINTED CCT. BOARD OF THE 2ND COMPONENT

### (1) Power supply circuits

Checking: a) Check and adjust each circuit voltage according to the same checking procedures of p.c.b. of the 1st component described in 7.2.6.

b) Detector voltage (for the 2nd component)

Check the voltage using SV2 and SC checking terminals.

The right voltage is written on the detector body.

(Adjust the detector voltage with VR1.)

### (2) Amplifier circuits

The amplifier circuits are to be checked after making sure that the power supply circuits function properly.

Checking: AC amplifier circuits

a) Connect a synchroscope between CP2 & SC checking terminals and observe AC waveform. While zero gas is introduced, amplitude of waveform is adjusted to be approx.  $3.5 \pm 1V$ -p by VR2.

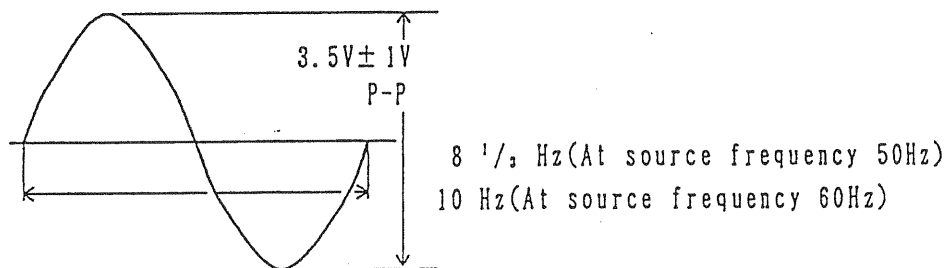

b) In case AC waveform cannot be observed in the above a), observe AC waveform on CP1 and SC checking terminals. When AC waveform of  $8 \frac{1}{2}$  Hz or 10 Hz is observed, AC amplifier Q1 is normal but AC amplifier Q2 or VR2 is defective.

c) In case AC waveform is not observed on CP1 and SC checking terminals, check detector according to 7.2.1.

(3) Rectifying circuits

Checking: a) While zero gas is introduced, check voltage between CP3 & SC checking terminals with a voltmeter.

The right voltage is approx. DC  $2.3 \pm 0.2V$ .

b) In case the voltage is much different from above described value, Q2 is defective.

7.3 ERROR-CODES AND HOW TO REPAIR

As self diagnostic functions are provided in the analyzer, an error-code is displayed on occasion of error.

In case an error is displayed, carry out checking and/or repairing according to the following table.

Error code	Error details	State of analyzer	Check or repair procedure
E - 0 E - 1	Error of digital part	Analyzer wouldn't work until recovered.	<ul style="list-style-type: none"> <li>• Turn off the power and turn on again.</li> </ul> <p>If the error code doesn't appear again, the analyzer is normal. If the error code appears again after trying the power off and on, it is necessary to replace the 1st comp. p.c.b..</p>
E - 2 E - 3	Error of temperature signal procedure	Analyzer's operative but indication is incorrect.	<ul style="list-style-type: none"> <li>• Turn off the power and turn on again.</li> <li>• Depress [ENT] key.</li> </ul> <p>If the error code appears again after that disappears once, replacement of the 1st comp. p.c.b. or the temperature sensor is necessary.</p>
E - 4 E - 5	Correction amount in calibration is out of allowable range	Measuring is possible but zero or span calibration of the range is not performed	<ul style="list-style-type: none"> <li>• Clean measuring cell.</li> <li>• Check the flowing gas concentration and the set value of span.</li> </ul>

(continues to the next page)

			• Check optical system
E - 6	Correction amount in calibration exceeds	Calibration cannot be performed.	Carry out the same as above.
E - 7	50% of measuring range		

Supplemental explanations on error codes

1. Error-code is displayed on the sub-display screen in the single component analyzer and on the sub-display screen of the 1st component in the dual components analyzer.
2. At the occasion of plural errors, the error codes are to be displayed in turn from the lower error-code No. by depressing [ENT] key.  
After displaying all error codes, the error codes display is once off by further depression of [ENT] key, however, the error codes appear again while the error state continues.
3. In case an error-code is displayed, firstly check whether power supply and gas piping are in good order or not.
4. At occasion of error, the contact output of FAULT closes.
5. At occasion of error during automatic calibration, the contact output of automatic calibration error closes together with the contact output of FAULT.

REVISIONS		
REV.	DESCRIPTION	DATE

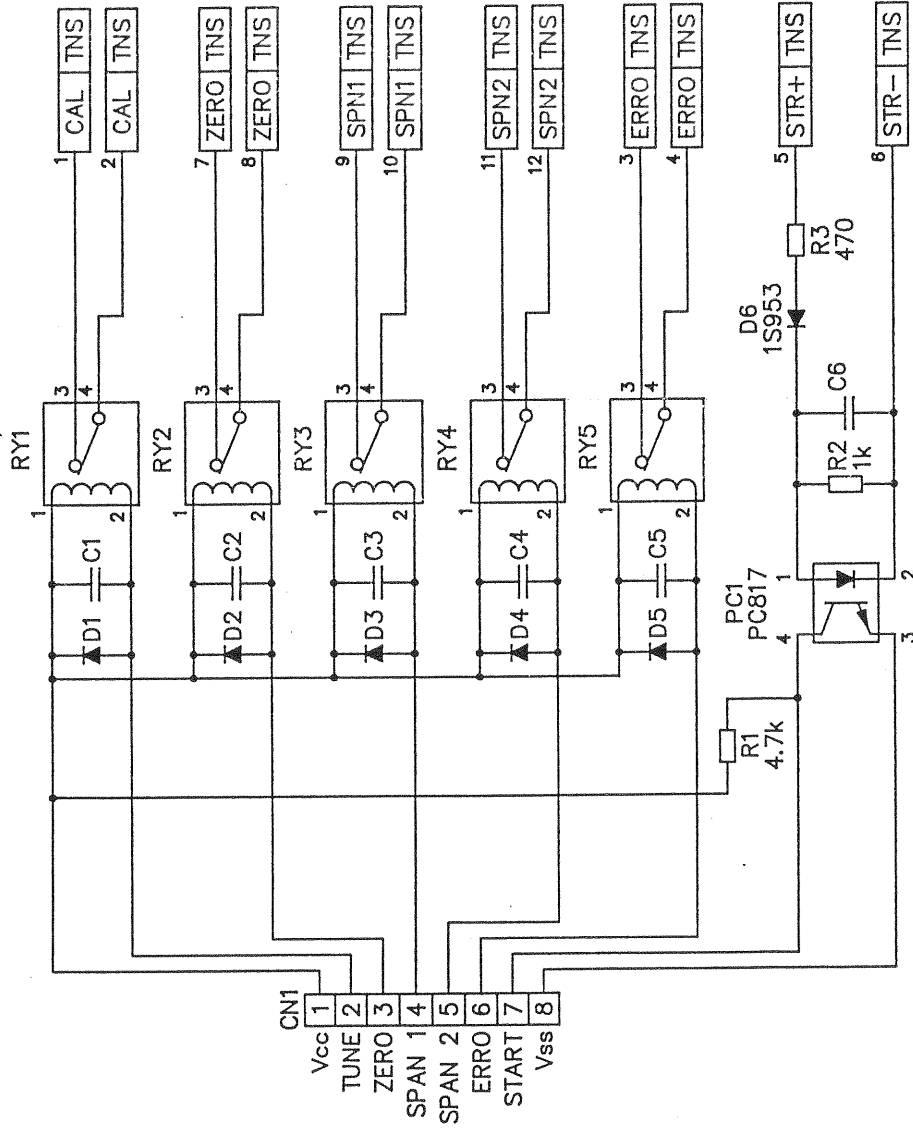

OUTPUT P.C.B.  
(AUTO CAL) (ZRH)

- 3. ALL CAPACITORS ARE 0.1 MICROFARAD.
  - 2. ALL RESISTOR VALUES ARE IN OHMS.
  - 1. ALL DIODES ARE SIB01-02
- NOTES: UNLESS OTHERWISE SPECIFIED.

THIS DOCUMENT AND THE DATA DISCLOSED HEREIN OR HEREWITH IS NOT TO BE REPRODUCED, USED, OR DISCLOSED IN WHOLE OR IN PART TO ANYONE WITHOUT THE WRITTEN PERMISSION OF CALIFORNIA ANALYTICAL INSTRUMENTS.		SIZE	FSCM NO.	DWG. NO.	REV.
		B		200279	
SCALE				7-24-95	SHEET

REV. NO.		DESCRIPTION		DATE		APPROVED	

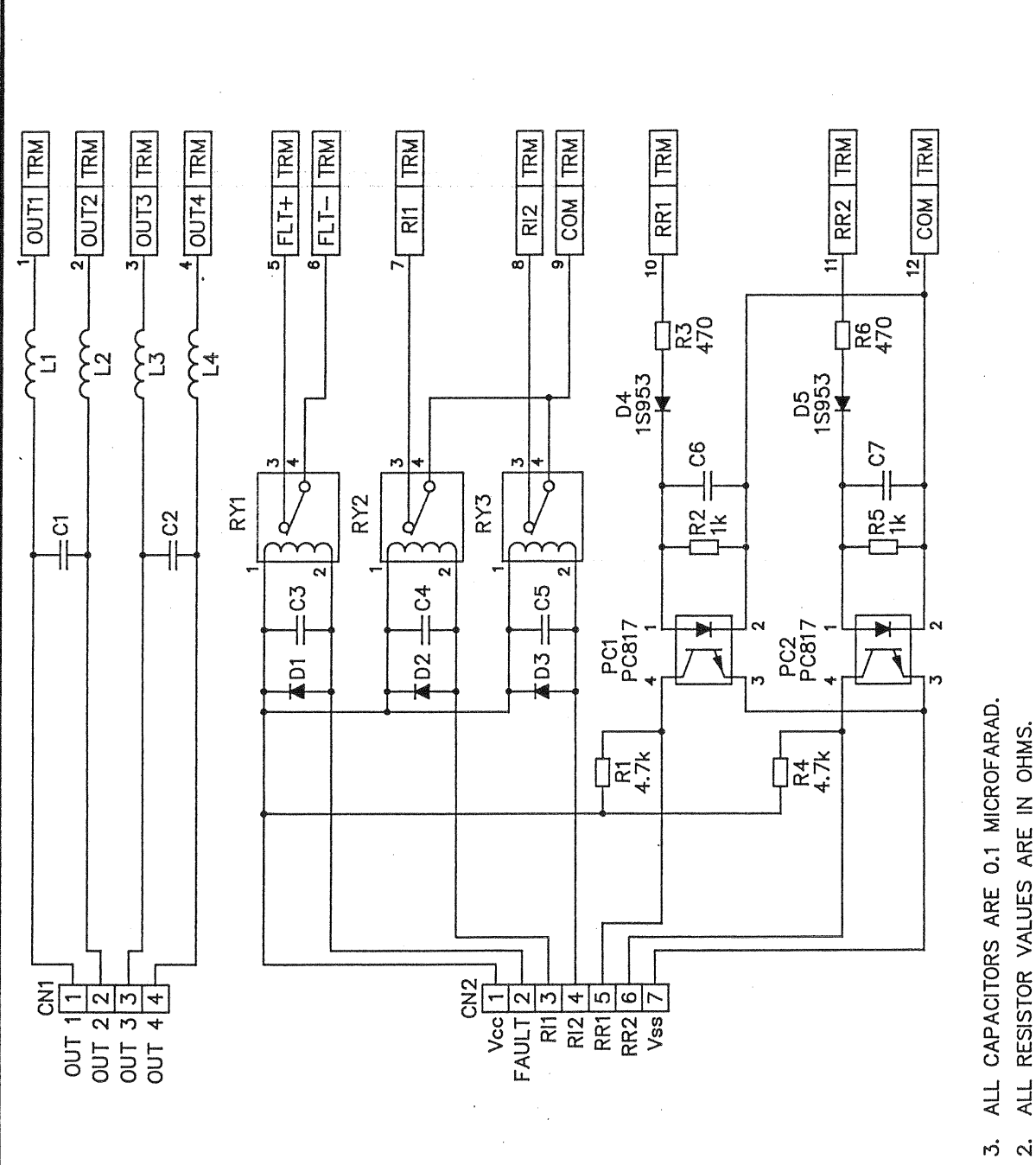

THIS DOCUMENT AND THE DATA DISCLOSED HEREIN OR HEREWITH IS NOT TO BE REPRODUCED, USED, OR DISCLOSED IN WHOLE OR IN PART TO ANYONE WITHOUT THE PERMISSION OF CALIFORNIA ANALYTICAL INSTRUMENTS.	SIZE	FSCM NO.	DWG. NO.	REV.
	B		200280	
SCALE	7-24-95		SHEET	

OUTPUT P.C.B.  
(COMP 1, COMP 2) (ZRH)

- 3. ALL CAPACITORS ARE 0.1 MICROFARAD.
  - 2. ALL RESISTOR VALUES ARE IN OHMS.
  - 1. ALL DIODES ARE SIB01-02
- NOTES: UNLESS OTHERWISE SPECIFIED.

REVISIONS		DATE	APPROVED
REV.	DESCRIPTION		

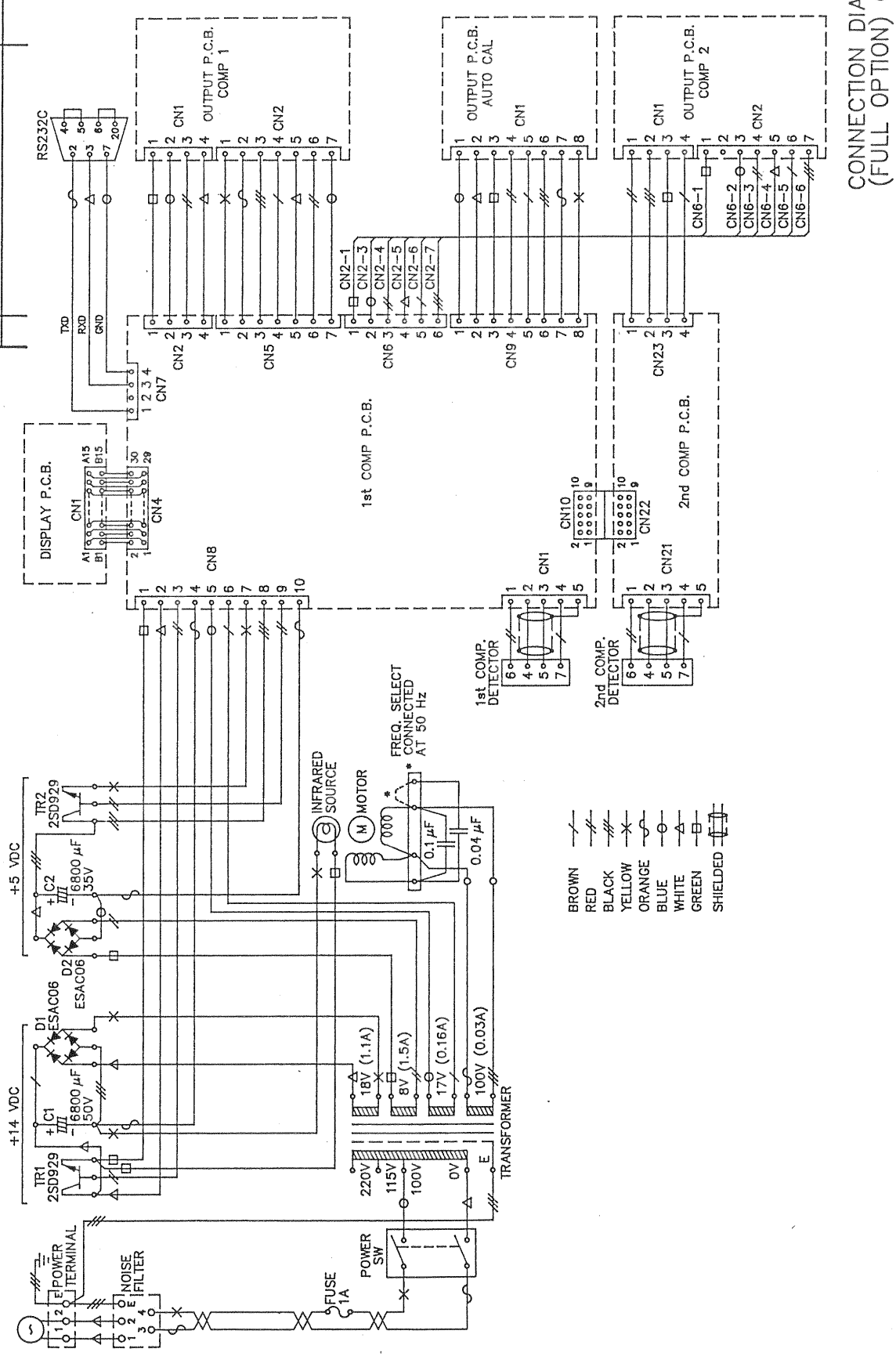

CONNECTION DIAGRAM  
(FULL OPTION) (ZRH)

THIS DOCUMENT AND THE DATA DISCLOSED HEREIN OR HEREWITNESS NOT TO BE REPRODUCED, USED, OR DISCLOSED IN WHOLE OR IN PART TO ANYONE WITHOUT THE WRITTEN PERMISSION OF CALIFORNIA ANALYTICAL INSTRUMENTS.	SIZE	FSCM NO.	DWG. NO.	REV.
B			200481	
SCALE	7-24-95		SHEET	