



700

Series

HCLD NO_x



Operators Manual

Table of Contents

Introduction	5
Analyzer Specifications	8
Installation	10
Safety Information	10
Startup and Shutdown	20
Using the Keypad.....	22
Menu Flow Chart.....	24
Main Menu	32
Measure Screen	33
Measure Mode.....	36
NO Mode.....	37
NO _x Mode	37
NO/NO _x /NO ₂ Mode	38
Analyzer Info	39
Remote/Manual.....	40
Standby.....	41
Menus	42
Calibration.....	43
Manual Calibration.....	44
NO or NO _x Mode.....	45
Zero	46
Span.....	49
NO/NO _x /NO ₂ Mode	51
Automated Calibration	52
Initiate Sequenced Cal.....	54
Initiate Sequenced Check	56
Cal Gas Concentrations	57
Calibration Setup.....	58
Auto Calibration Schedule	59
Auto Calibration Parameters	61
Calibration Via Pump/Valves	63
Auto Calibration/Check	64
Auto Calibration Timing	65
Deviation Limits.....	67
Maximum Calibration Error.....	68
Maximum Verifying Error	69
Analog Hold on Cal	70
Calibration Factors	71
Manual Deviations	72
Zero Gas Deviations.....	73
Span Gas Deviations	74
Auto Cal Deviations.....	75
Verifying Zero Deviations	76
Verifying Span Deviations	77
Offset/Gain Factors	78
Reset Factory Settings.....	79

Range Setup	82
Range Limits	83
Auto Range On/Off	85
Auto Range Switch Points	86
Diagnostics	87
Diagnostic Values	88
Raw Values Display	90
I/O Status	92
Analyzer Digital Outputs	93
Analyzer Digital Inputs	94
Programmable Digital Outputs	95
Status Line	96
Setup Menu	97
Measure Settings	98
Averaging Time	99
NO/NO _x /NO ₂ Mode Times	100
NO _x Correction Factors	101
Output Settings	103
Programmable Analogs	104
Output Assignments	105
Output Scaling	107
Output Adjustments	109
Programmable Digitals	111
Output Assignments	112
Output Hold/Clear	115
Output Test	116
TCP/IP Parameters	118
Data Logging Time	119
Auto Start Settings	120
Clock Settings	122
Alarms Menu	123
Current Alarms	124
Alarm Log	125
Alarm Limits	127
Temperatures	128
Pressures	129
EPC Voltages	130
Concentrations	131
Alarm Display On/Off	132
Service Menu	133
Linear Coefficients	134
Service Menu	136
Security	137
Operator Levels	138
Change Password	139
Reset Password	140
Communication and Interface	141
Analog and Digital Interface	142
Serial Interface	146
AK Protocol	147

Instruction Command.....	149
Error Handling	151
General AK Requirements	152
Scan Commands.....	154
Control Commands	165
Configuration Commands	169
Modbus Protocol	175
MBAP Description.....	175
MBAP Header Description	176
Modbus Command Function Codes.....	177
Modbus Map	194
01H Single-Read Coil	194
05H Write Single Coil.....	196
03H Read Floating Point.....	197
16H Write Floating Point	199
Warranty Statement	201

Introduction



Thank you for purchasing the CAI 700 HCLD Analyzer. Before using the 700 HCLD, please familiarize yourself with its operation by reading this manual. If you have any questions, please do not hesitate to call California Analytical Instruments Technical Support for assistance. We want you to be among our thousands of satisfied customers.

Description

The CAI 700 HCLD Analyzer is an exceptionally accurate chemiluminescent gas analyzer designed for measuring oxides of nitrogen concentrations in gas samples. The HCLD includes a unique internal oven, which maintains all plumbing components in contact with the sample gas, before the detector, at an elevated, customer-specified temperature between 85° and 100°.

Features

- Measurements from 3 to 3,000 ppm full-scale NO/NO₂/NO_x
- Automatic calibration and ranging
- Fast response time
- Unique internal oven
- Electronic control of sample and ozone flow
- Selectable output options of current or 1, 5 or 10 VDC
- Communication via RS-232, AK protocol TCP/IP and Modbus TCP/IP

- CE Mark and ETL listed to UL STD 61010-1; certified to CAN/CSA C22.2 STD 61010.1
- 1065-compliant configurations

Operating Principle

The CAI 700 HCLD Analyzer utilizes the principle of chemiluminescence for analyzing the NO, NO_x or NO₂ concentration within a gaseous sample.

In the NO mode, the measurement is based upon the chemiluminescent reaction between ozone and nitric oxide (NO), yielding nitrogen dioxide (NO₂) and oxygen. This reaction produces light which has intensity proportional to the mass flow rate of NO₂ into the reaction chamber. The light is measured by means of a photodiode and associated amplification electronics.

In the NO_x mode, NO plus NO₂ is determined as above; however, the sample is first routed through the internal NO₂ to NO converter which converts the NO₂ in the sample to NO. The resultant reaction is directly proportional to the total concentration of NO_x. Sample enters the analyzer directly into a heated chamber and is maintained at an elevated temperature. The moisture will remain in the vapor state, ensuring no loss of the NO₂.

Reaction Chamber

The sample and ozone are delivered to the reaction chamber via the unique regulated flow system described below, and mixed together at the center of the chamber where the reaction takes place. The sample is vented from the chamber through a ¼-inch tube. The chamber contains a long-pass filter that is sealed with an integral O ring. The chamber assembly is mounted to the photodiode.

Flow System

The flow system's basic function is to deliver highly regulated flows of sample and air or O₂ to the ozonator and reaction chamber assemblies. The EPC (electronic proportional control) valve delivers approximately 15 PSIG (standard without ozone pump option) to a pre-set capillary and consequently accurately predetermines the ozone flow rate. The air supply cylinder should be set to 25 PSIG.

Sample flows through the sample EPC valve, the NO/NO_x solenoid valve, the sample capillary and into the reaction chamber. The sample pressure is factory set to approximately 3.85 PSIG (standard without low-pressure option). A close-coupled bypass capillary minimizes dead volume and improves response time. Sample inlet pressure and regulated air pressures are monitored by internal pressure transducers and presented in PSIG via the Diagnostics screen.

NOTE: The correct pressures are determined by the factory for optimal analyzer performance and are recorded on the [Factory Settings Screen](#) in the analyzer.

Analyzer Specifications

Specifications are subject to change without notice.

Detector: Chemiluminescence photodiode (thermally stabilized with Peltier cooler).

NO/NO_x Ranges: Four operator-definable ranges from 0-3 to 0-3,000 ppm standard (consult factory for other ranges).

Response Time: T90 < 2 seconds to 60 seconds (adjustable).

Resolution: 10 ppb NO/NO_x (displays 5 significant digits).

Repeatability: Better than 0.5% of full scale.

Linearity: Better than 0.5% of full scale.

Noise: Less than 1% of full scale.

Zero and Span Drift: Less than 1% of full scale per 24-hour period.

Zero and Span Adjustment: Via front panel, digital input, Modbus or AK Protocol.

NH₃, HCN and SO₂ Effect: less than 100 ppm not detectable.

CO₂ Effect: Less than 2% with 10% CO₂.

Flow Control: Electronic proportional pressure controller.

Sample Flow Rate: 2.5 LPM (other flow rate options available).

Converter: Vitreous carbon material (> 95% efficiency at 205°C).

Ozonator: Ultraviolet lamp.

Air or O₂ Requirements: Less than 0.01 ppm NO_x and Dew point < -10°C. (Approx 350 cc/Min at 25 PSIG)

NO/NO_x Control: Via Front Panel, Auto Cycle, Digital input, Modbus or AK Protocol.

Outputs: AK Protocol (TCP/IP and Serial RS-232), Modbus TCP/IP and 4 programmable, scalable analog outputs (Voltage or Current).

Alarms and Statuses: 15 operator-defined digital contact closures.

Digital Diagnostics: Control Voltages, Temperatures, Pressures and Flows.

Special Features:

- Calculated NO₂ derived from NO_x converter efficiency.
- Auto ranging.
- Auto calibration (adjustable through internal clock).
- < 3 cc gold-plated reaction chamber.
- Oven temperature to 85°C (100°C on request)

Display: 3" x 5" backlit LCD.

Sample Temperature: Up to 100°C non-condensing sample.

Ambient Temperature: 5 to 40°C.

Ambient Humidity: Less than 90% RH non-condensing.

Warm-up Time: 1 hour (typical).

Fittings: ¼-inch tube fittings.

Power Requirements: 115 VAC/60 Hz or 230 VAC/50 Hz (±10% 750 Watts).

Dimensions: 5¼ H x 19 W x 23 D (inches).

Weight: Approximately 55 lbs. depending on options.

Installation

Safety Information



Safety Alert

Caution or Warning



Temperature Hazard

Caution or Warning



Electrical Shock Hazard

Caution or Warning

Note, Caution and Warning symbols appear on the instrument and in this manual to draw your attention to important operational and safety information.

A “**NOTE**” marks a short message to alert you to an important detail.

A “**CAUTION**” safety alert appears with information that is important for protecting your equipment and its performance.

A “**WARNING**” safety alert appears with information that is important for protecting you, other people and equipment from damage. Pay especially close attention to all warnings that apply to your application.



The  symbol (an exclamation point in a triangle) precedes a general CAUTION or WARNING statement.



The  symbol (wavy vertical lines with an underscore in a triangle) precedes an elevated temperature hazard CAUTION or WARNING statement.



The  symbol (a lightning bolt in a triangle) precedes an electrical shock hazard CAUTION or WARNING statement.

Some or all of the above symbols may appear in this manual or on the equipment. This manual should be consulted whenever one of these symbols is encountered on the equipment.

Electrical Shock Hazard

Do not operate the analyzer without the cover secured. Servicing the analyzer requires access to live electrical circuits that can cause death or serious injury. Refer servicing to qualified service personnel. For safety and proper performance, connect this instrument to a properly grounded three-wire receptacle.

Safety Information - service and repair

Servicing the analyzer must be performed by qualified trained personnel.

ALWAYS REMOVE POWER BEFORE CONNECTING OR DISCONNECTING SIGNAL CABLES OR WHEN SERVICING THE EQUIPMENT.



 During service with top cover removed AC power voltage runs from the power entry module to the relay board and is distributed to AC powered components.



 Gas connections both interior and exterior at rear panel.

All gas connections must be checked for leaks with a certified leak checking device.



 The analyzer is equipped with a UV (254nm) lamp.

ALWAYS REMOVE POWER BEFORE SERVICING THE UV LAMP



Oven: There are valves and a pump head that penetrate the oven wall. These parts at the exterior wall range in temperature from 50°C to 60°C.

ALWAYS ALLOW OVEN TO COOL TO ROOM TEMPERATURE BEFORE PROCEEDING WITH SERVICE.



Some sheet metal and components have sharp edges. Use care when servicing the analyzer. Avoid pinch point when installing analyzer cover. Replace cover with finger tips squarely pressed on the side flanges and not at the end of the flanges when dropping cover into place. Always reinstall all (4) cover screws.



Never replace main power cord with an inadequately rated power cord.

Main power cord must be minimum rating: 10Amp/250Volts



Never replace fuses with incorrectly rated fuses:

Fuse rating for 115V 60Hz analyzers: MDL8A/250V or equivalent

Fuse rating for 230V 50Hz analyzers: GDC4A/250V or equivalent

Unpacking Instructions

Open the shipping container and carefully remove the analyzer from the packing materials. Inspect the instrument for any sign of damage. Remove the top-cover retaining screws. Visually check for loose parts or connectors that are not properly seated. Verify that all circuit boards and circuit board connections are secure. If all internal components look normal, re-install the cover.

IMPORTANT: You should save the original shipping container your analyzer arrives in. The shipping container and packaging are specially designed to protect the analyzer in transport. If you ever need to return the analyzer to CAI for repair or any other reason, the original shipping container and packaging should be used.

Reporting Damage

Should there be any apparent damage to either the inside or outside of the instrument due to shipping or handling, immediately notify the shipping company and CAI. The shipping container or packing materials should be retained for inspection by the shipper.

Contact Information

California Analytical Instruments, Inc.

1312 West Grove Avenue

Orange, CA 92865

714-974-5560

714-921-2531

www.gasanalyzers.com

Rack Mounting

The front panel is designed for mounting into a standard 19-inch rack enclosure. Holes are located on the left and right side to allow the panel to be secured in the rack by screws. Optional rack slides allow the analyzer to be pulled out of the rack enclosure for access.

Rear Panel

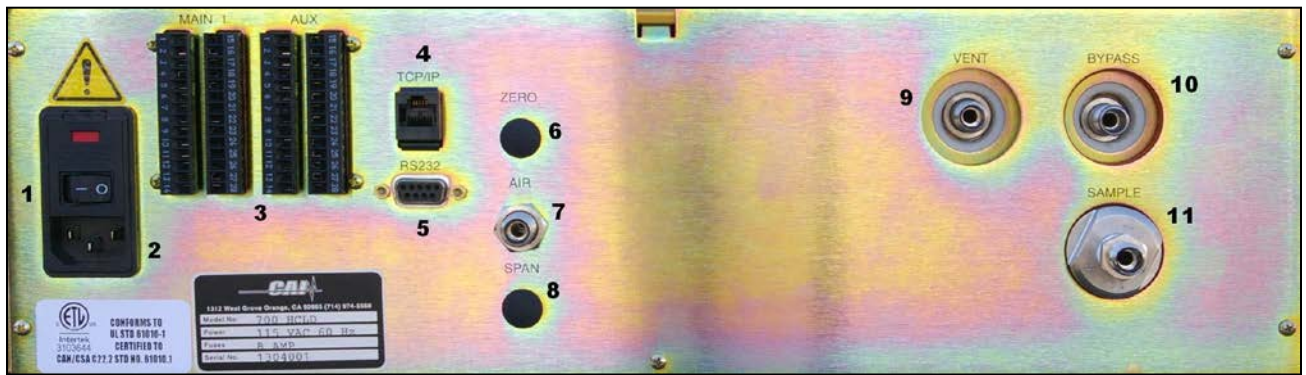

The rear panel includes the following:

1. Rear-panel Power ON/OFF switch.
2. Power Entry module for power connection, power switch, fuse compartment.
3. Connectors for analog and digital outputs and inputs.
4. RS232 Serial connection for serial cable.
5. TCP/IP RJ-47 connection to network cable.
6. Zero Gas inlet for introducing hydrocarbon-free zero air or N₂ to the analyzer (optional).
7. Ozone air inlet for introducing hydrocarbon-free air or oxygen to the ozone generator.
8. Span Gas inlet for introducing calibration gas to the analyzer (optional).
9. Vent to exhaust from reaction chamber, ¼-inch tube fitting.
10. Sample Gas Bypass outlet (vent) for exhaust of sample (¼-inch tube).
11. Sample Gas inlet for introducing sample gas into the analyzer (¼-inch tube).

Site Selection and Mounting



CAUTION: *The following precautions must be carefully observed:*

1. Select a site free from direct sunlight, radiation from a high-temperature surface, or abrupt temperature variations.
2. This analyzer is *not* suitable for installation outdoors.
3. Select a site where the air is clean. Avoid exposing the instrument to corrosive or combustible gases.
4. The instrument must not be subject to severe vibration. If severe vibration is present, use isolation mounts.
5. The instrument is designed for rack mounting. Optional rack-mount slides are available.
6. Do not install the 700 HCLD analyzer near equipment that emits electromagnetic interference (EMI).

NOTE: *A front and rear supporting brace or equivalent is required if the optional rack-mount slides were not purchased.*



The Power On/Off switch is accessible from the rear of the analyzer only. **DO NOT** mount the analyzer in a manner that leaves the Power On/Off switch inaccessible.

Electrical

All wiring is connected at the rear of the analyzer. The AC power cord is connected to the power cord outlet as shown below:

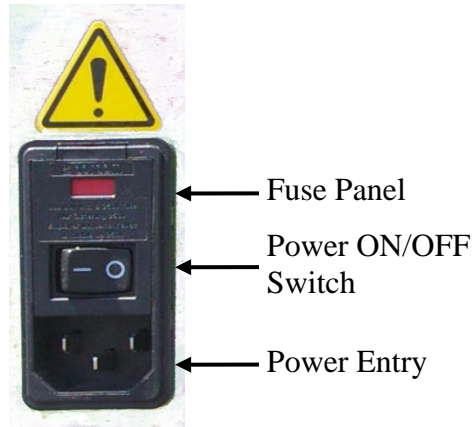

AC Power Switch, Connector and Fuse.

NOTE: A defective ground may affect the analyzer's operation. Shielded wiring is recommended for output signals.

Output Connections

See the [Analog and Digital Interface](#) section of this Manual for instructions for the various output selection options. Shielded wiring is recommended for output signals.

Recommended Gases

Zero calibration for the 700 HCLD requires ultra high-purity nitrogen (UHP N₂) or calibration-grade air, plus a span gas. The recommended span gas for this analyzer is NO in a background of N₂. NO in a background of air is not recommended as some of it will convert to NO₂.

Calibration gases can be introduced through the calibration ports on the back of the analyzer (if optional solenoid valves have been installed) or through the sample inlet.

Gases introduced through a calibration port should be at 20-25 PSIG. If introduced through the sample port, pressures should be as follows:

1. Without sample pump, pressure should be 10-25 PSIG.
2. With sample pump – no pressure.
3. Low-pressure configuration should be 3-7 PSIG.

Gas Handling Equipment

Pressure regulators for zero gas (air or N₂), ozone supply (air or O₂) and span gas cylinders are required for gas analysis by the 700 HCLD analyzer.

NOTE: High levels of ammonia (greater than 10 ppm NH₃) may reduce the NO₂/NO converter's efficiency to a level that is unacceptable. If ammonia levels above 10 ppm are expected, it is recommended that a commercially available ammonia scrubber be purchased and installed on the sample line prior to the sample entering the analyzer.

Gas Connections

If the calibration gases are not connected to calibration inlets on the back of the analyzer (if optional solenoid valves have been installed), the cal gases will need to be delivered through the sample port at the pressure settings listed above.

The tubing from the sampling system to the gas analyzer should be made from corrosive-resistant material such as Teflon or Stainless Steel. Rubber or soft vinyl tubing should not be used since readings may be inaccurate due to gas absorption into the tubing material. For fast response, the tubing should be as short as possible. Optimum tube internal diameter is 0.16 inch (4 mm). Couplings to the instrument are ¼-inch tube.



CAUTION: *Be sure tubing and joints are clean. Dust entering the instrument may cause it to malfunction.*

Sampling Requirements

Filtration

Dust must be eliminated completely in the sample stream. Use filters as necessary. The final filter must be capable of removing any particles larger than 4 microns.

Condensation

The dew point of the sample gases must be lower than the instrument temperature to prevent accidental condensation within the instrument. If necessary, bypass the sample through a dehumidifier to reduce the dew point to 4°C or less. If the sample contains an acid mist, use an acid mist filter, cooler or similar device to remove all traces of the mist.

Presence of Corrosive Gases

The useful service life of the instrument will be shortened if high concentrations of corrosive gases such as Cl₂, SO₂, F₂, HCl etc. are present in the sampled gas.

Gas Temperature

When measuring high-temperature gases, make sure that the maximum temperature rating of the instrument 212°F (100°C) is not exceeded.

Pressure and Flow Rates

The air or oxygen supply entering the instrument is controlled by a proportional flow (EPC) controller. The regulator is factory adjusted for optimal analyzer performance.

The ozone supply (air or O₂) air cylinder pressure should be set at approximately 25 PSIG (standard without ozone pump option). The sample entering the instrument is controlled by a factory-set, precision, electronically controlled proportional flow (EPC) controller.

If the analyzer does not contain an optional internal sample pump, the sample gas entering the instrument should be at a pressure between 10 and 25 PSIG with a flow capacity at a minimum of 3 liters/min.

If the analyzer is using the optional sample pump, do not introduce a pressurized sample. The optional standard pump is capable of drawing a sample through a ¼-inch heated sample line of approximately 85 feet. The calibration gas cylinder pressures should be set at 25 PSIG for delivery into the optional zero and span inlets located on the rear panel.



CAUTION: *If the analyzer contains an optional internal sample pump, the introduction of a pressurized sample gas in excess of 1.5 PSIG will damage the pump.*

Sample Gas Bypass Outlet and Vent

A sample gas bypass outlet connector is located on the analyzer's rear panel (¼-inch tube). Pressure at this outlet should be kept at atmospheric level. **ANY** backpressure will cause an error in reading. The vent outlet is located on the rear panel and may contain high levels of ozone that should be vented away from the instrument.

Startup and Shutdown

Before using the analyzer, make sure the external plumbing and wiring have been connected correctly as shown in the Rear Panel description. All connections should be leak-tight, and inlet pressure settings adjusted as previously described.

NOTE: Make sure the proper connections for the vents for the reaction chamber and sample have been made prior to powering on the analyzer, since ozone will be flowing from these vents.

Turn on the Power switch on the analyzer's rear panel. After a short delay, the digital display should illuminate. If the display does not come on, check the power source and the fuse. If the problem persists, call CAI Technical Support.

Refer to the [Using the Keypad](#) section and review the complete Operator's Manual for detailed instructions for proper setup and operation of the 700 HCLD.

Shutdown Procedure

1. Turn off the valves on the zero, span and air cylinders.
2. If the analyzer contains the optional internal sample pump, disconnect the sample line from the rear inlet port. **Do NOT turn off the sample pump or analyzer power at this point. Any pressurization of the pump could cause damage.**
3. Allow the analyzer to draw in room air for approximately 10 minutes, or flush out any remaining sample that could cause condensation as the analyzer cools.
4. Turn off the optional internal sample pump by setting the analyzer to [Standby](#).
5. Turn off the analyzer power.

Proper Storage

After power down, allow the heated analyzer components to cool to room temperature before preparing for storage.

If the original shipping box was retained, the analyzer should be stored in the box in the packing material supplied. If the original box is not available and another appropriate box cannot be obtained, the analyzer can be placed in a clean, dry plastic bag.

Storage should be in a reasonably temperature-controlled environment and away from any possible exposure to dust and water or other liquids.

Using the Keypad

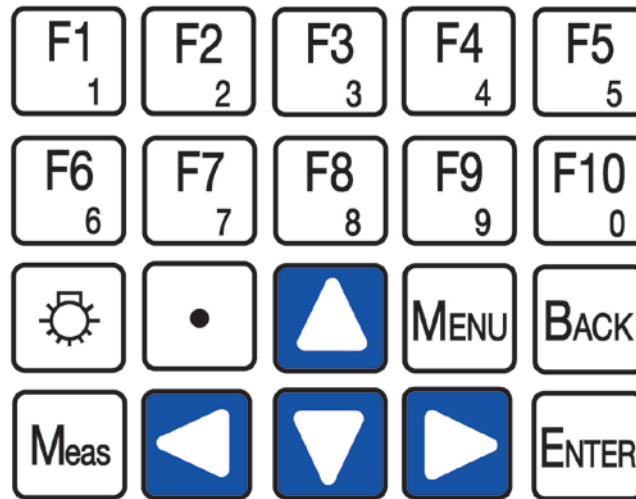

When the Measure screen is displayed, the ten **Function keys (F1 through F10)** are shortcuts to commonly used screens. On other screens, these keys can either be used as function keys or to enter numeric values. This is why each number key includes both the larger **Function number** at the top (for example, F1) and the smaller number underneath for **numeric value** (for example, 1). 



The Light key is used to turn the display's backlight on and off.



The Decimal Point key is used to enter a decimal point when a numeric value is keyed in.



The Menu key is used to bring you to the Main Menu at any time.



The Back key is used to return to the previous screen.



From any screen, the Measure key takes you to the Measure screen. The current measurement is being displayed.





The Enter key:



1. In Function mode, the Enter key selects the highlighted function.
2. When a field is highlighted for numeric input, pressing the Enter key opens the selected field for numeric entry with a blinking cursor. Pressing the Enter key a second time exits the Numeric Entry field.

An **N** will be displayed in the bottom-right corner of the screen when the analyzer is in **Numeric Entry** mode. An **F** is displayed when the analyzer is being used for **Function** mode.



In Function mode, the **arrow keys** move the highlight. Press the Enter key to accept the highlighted function. In Numeric mode these keys control the cursor. Arrow key functions will vary as is shown on some screens.

In Numeric mode, the left and right arrow keys   allow you to move the blinking cursor.

The up and down arrow keys   change the value within a field that has the cursor underneath it. The arrow keys are also used to scroll the input possibilities and edit the numbers.

Menu Flow Chart

The menu flow chart is a handy reference that will help you familiarize yourself with the operation of the CAI System 700 HCLD Analyzer. Start by pressing  to access the Main Menu to quickly find any screen.

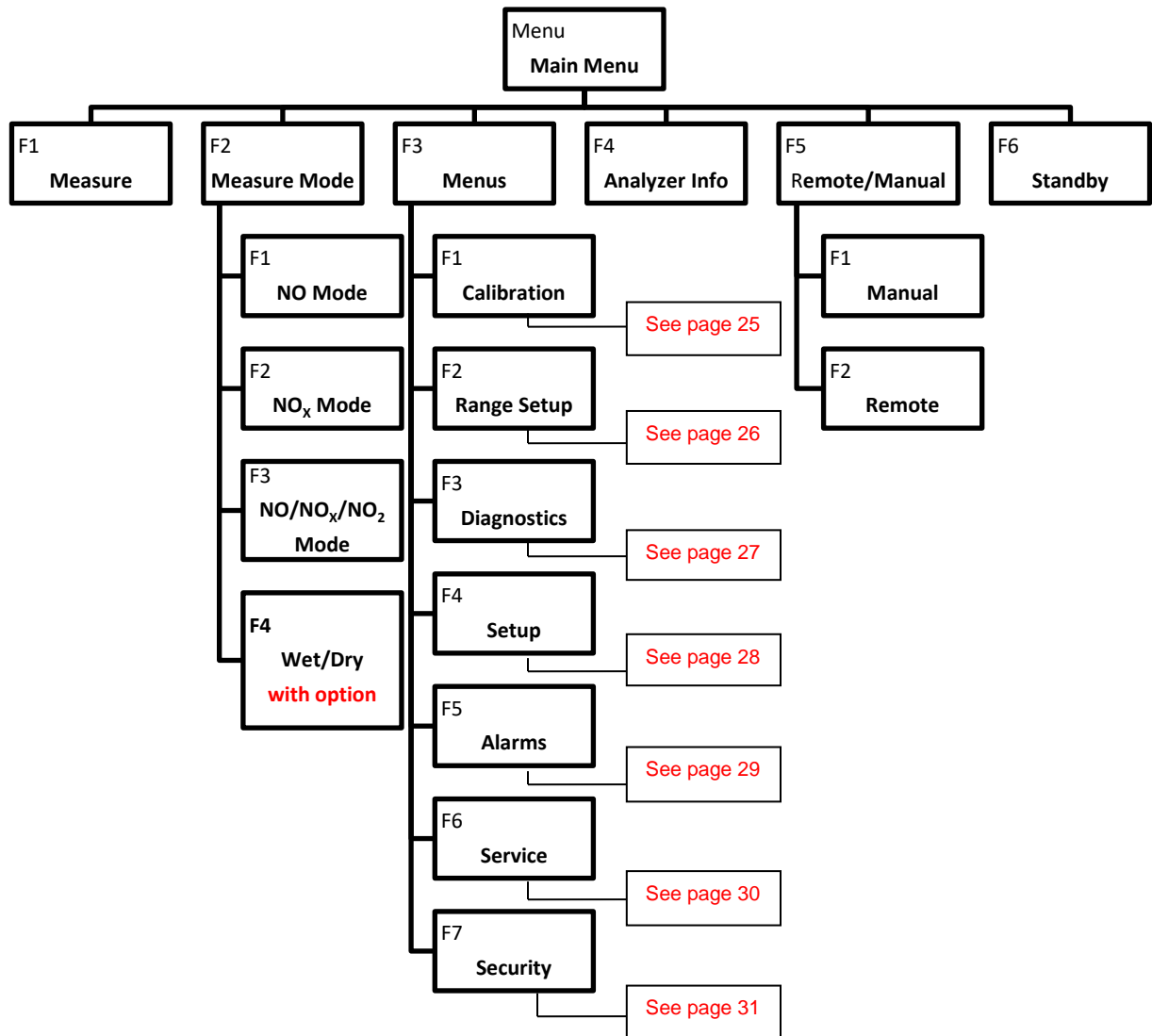

Calibration

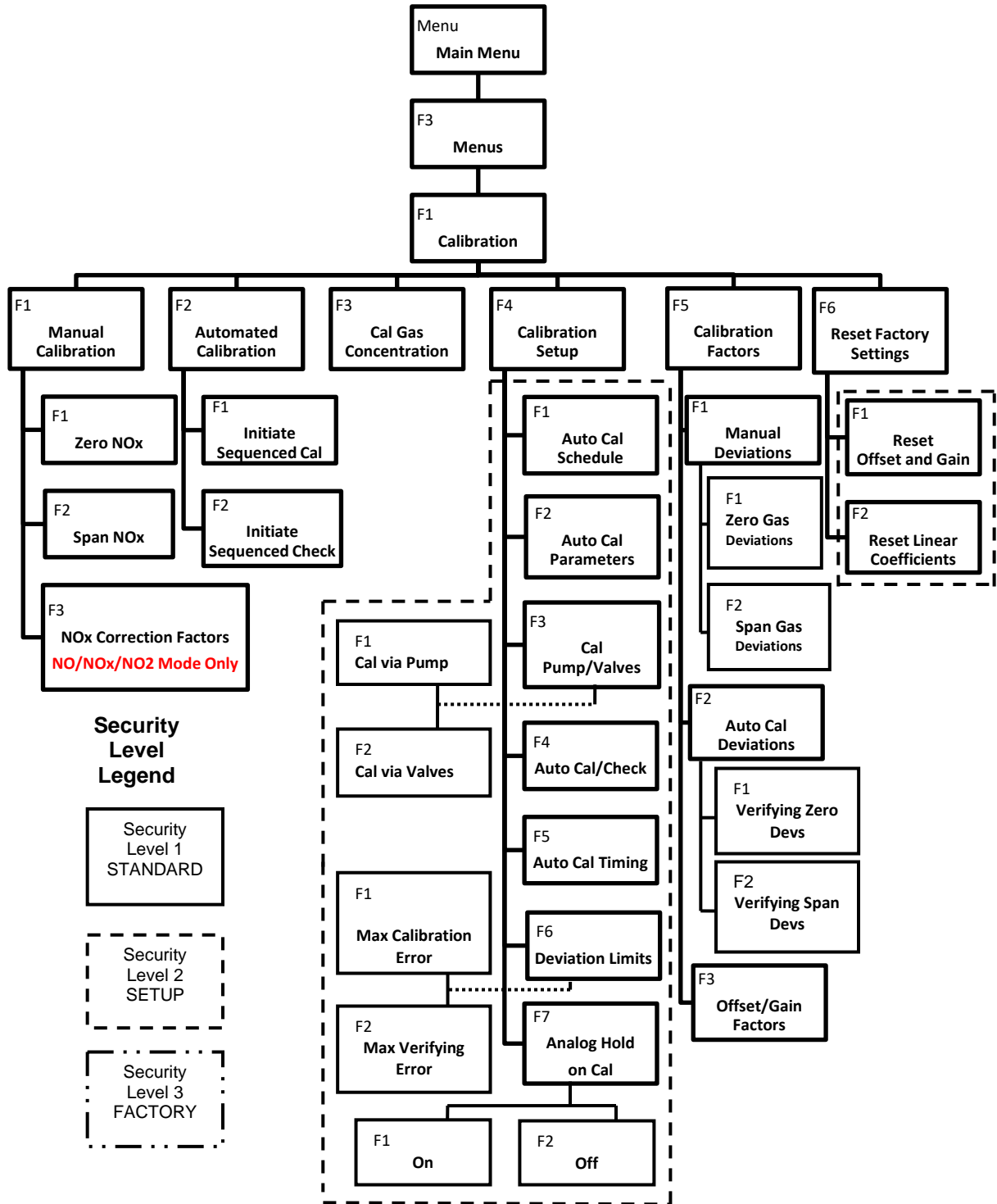

Range Setup

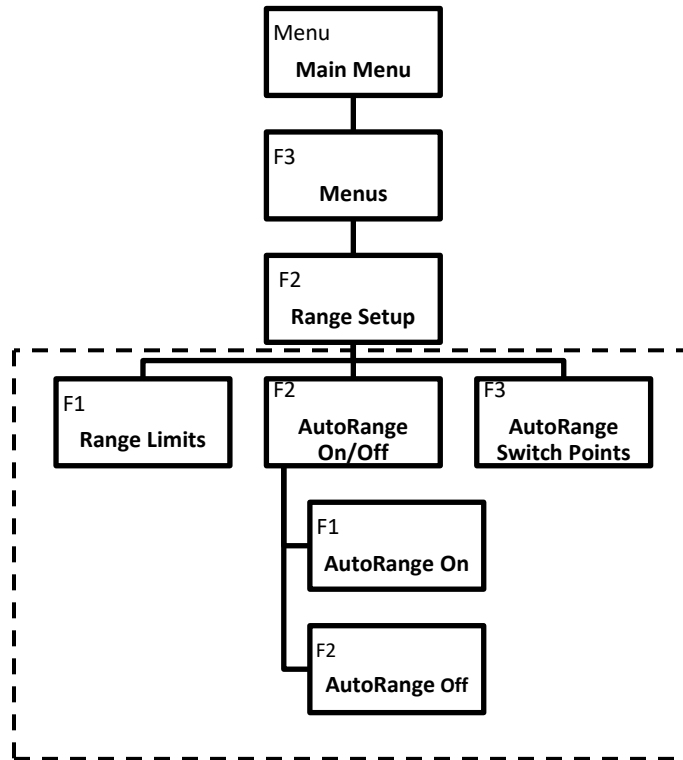

Security Level Legend



Diagnostics

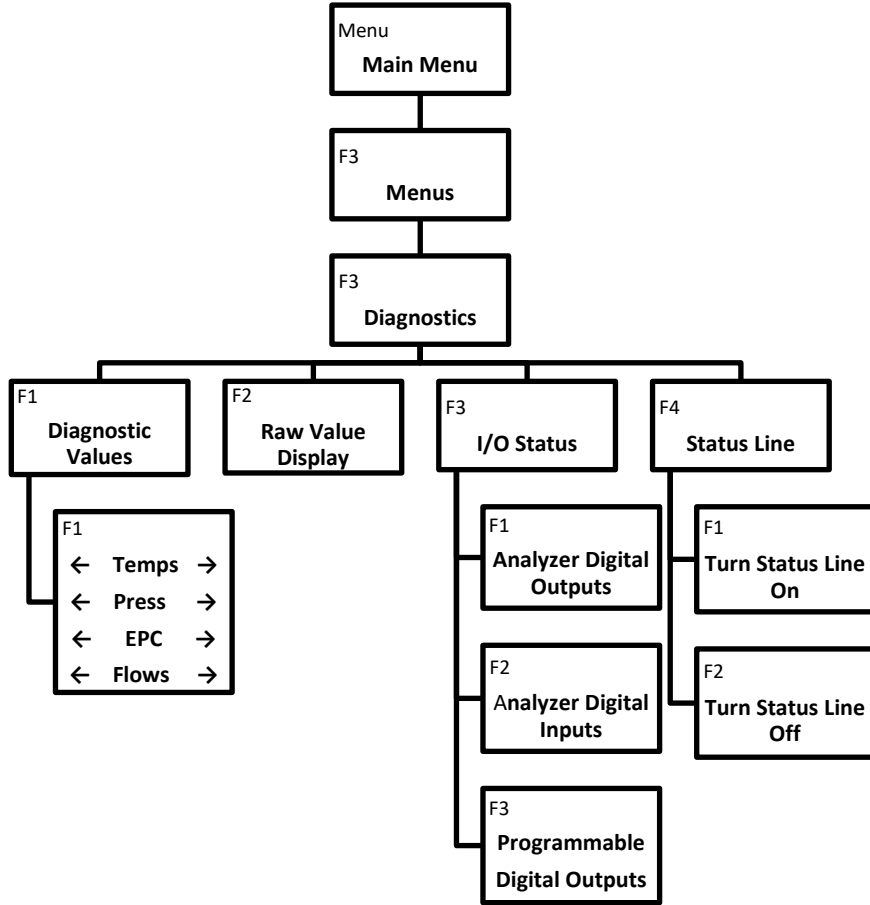

Setup

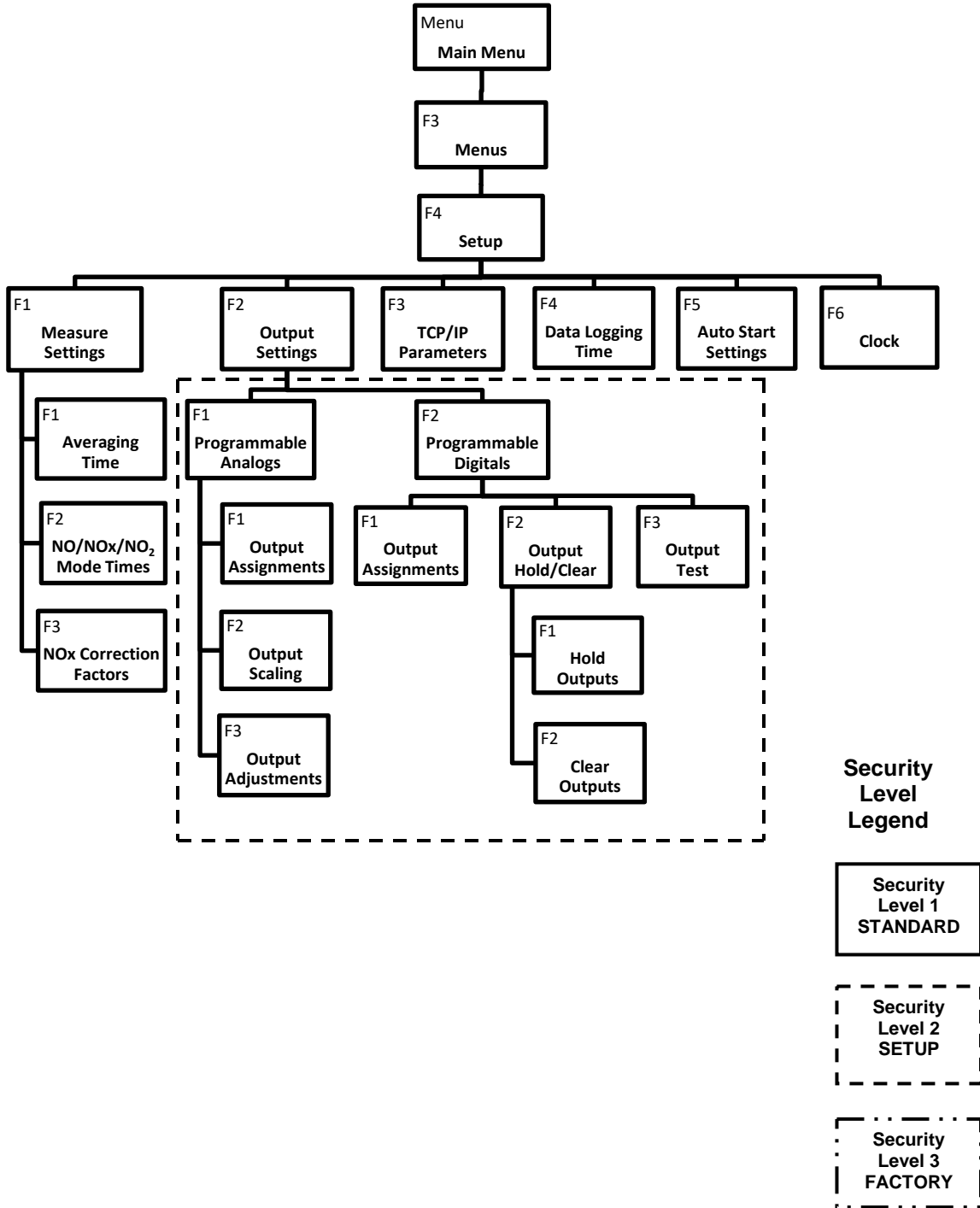

Alarms

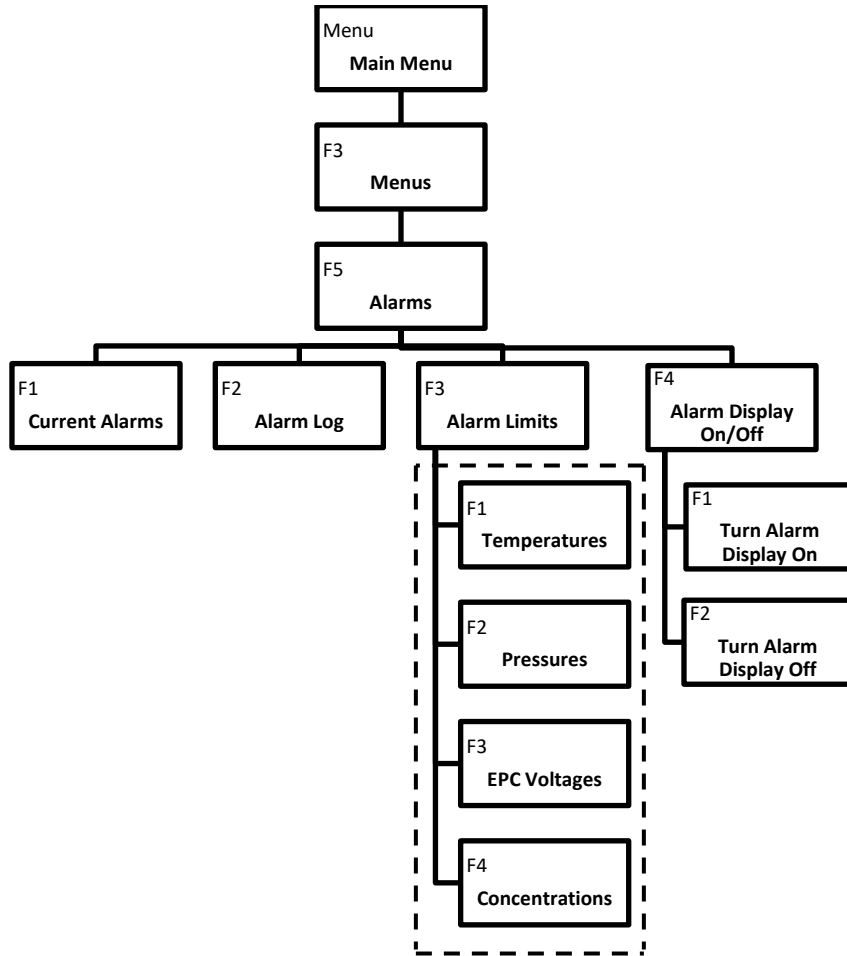

Security Level Legend

Security Level 1 STANDARD

Security Level 2 SETUP

Security Level 3 FACTORY

Service

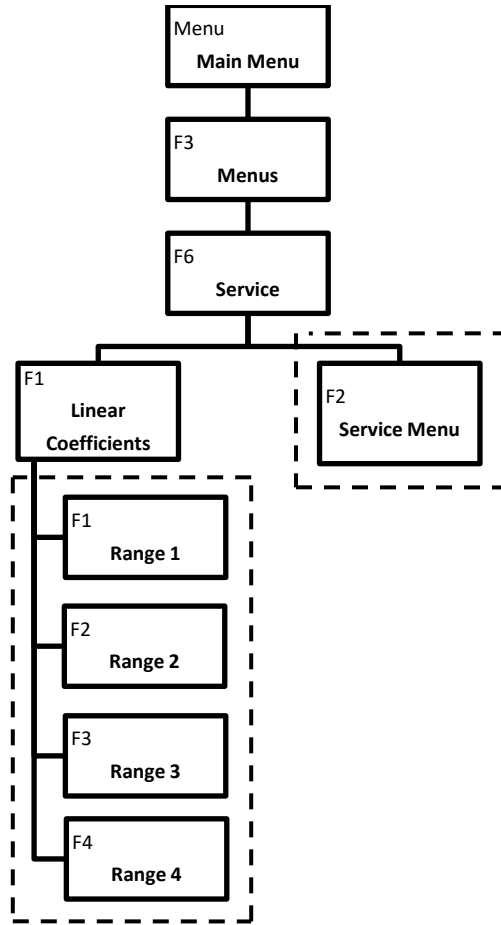

Security Level Legend

Security Level 1
STANDARD

Security Level 2
SETUP

Security Level 3
FACTORY

Security

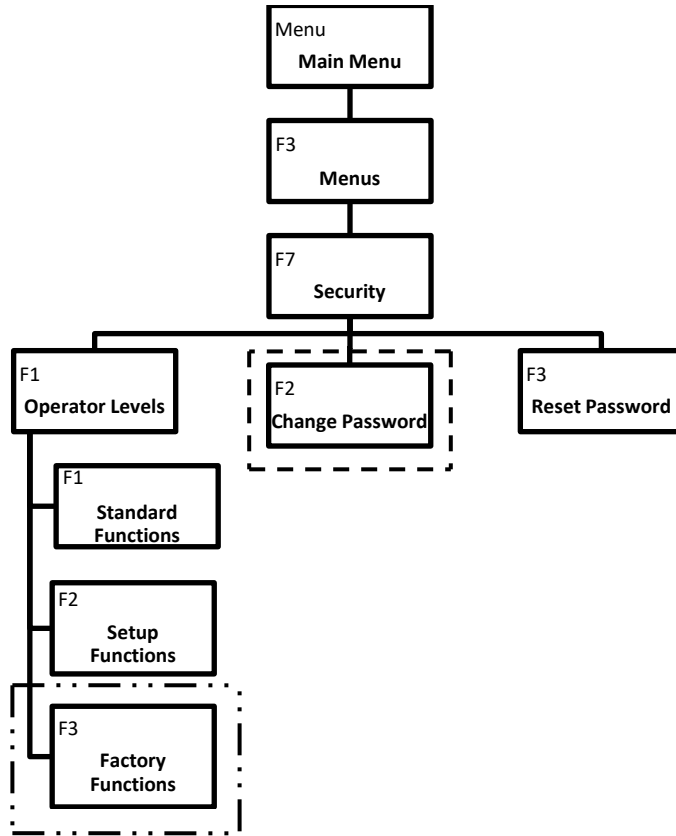

Security Level Legend

Security Level 1
STANDARD

Security Level 2
SETUP







Security Level 3
FACTORY

Main Menu





Main Menu	
F1	Measure
F2	Measure Mode
F3	Menus
F4	Analyzer Info
F5	Remote/Manual... SREM
F6	Standby

The Main Menu is your gateway to operational, setup and maintenance functions on the 700 Series HCLD Analyzer via the corresponding function keys. All software functions of the 700 HCLD can be reached via the menu above from the Main Menu screen.

Operation starts by pressing the Menu key  to bring up the Main Menu. Use the Arrow keys     to highlight the desired function and press  to open the screen. You can also access the desired function by pressing the corresponding function key.

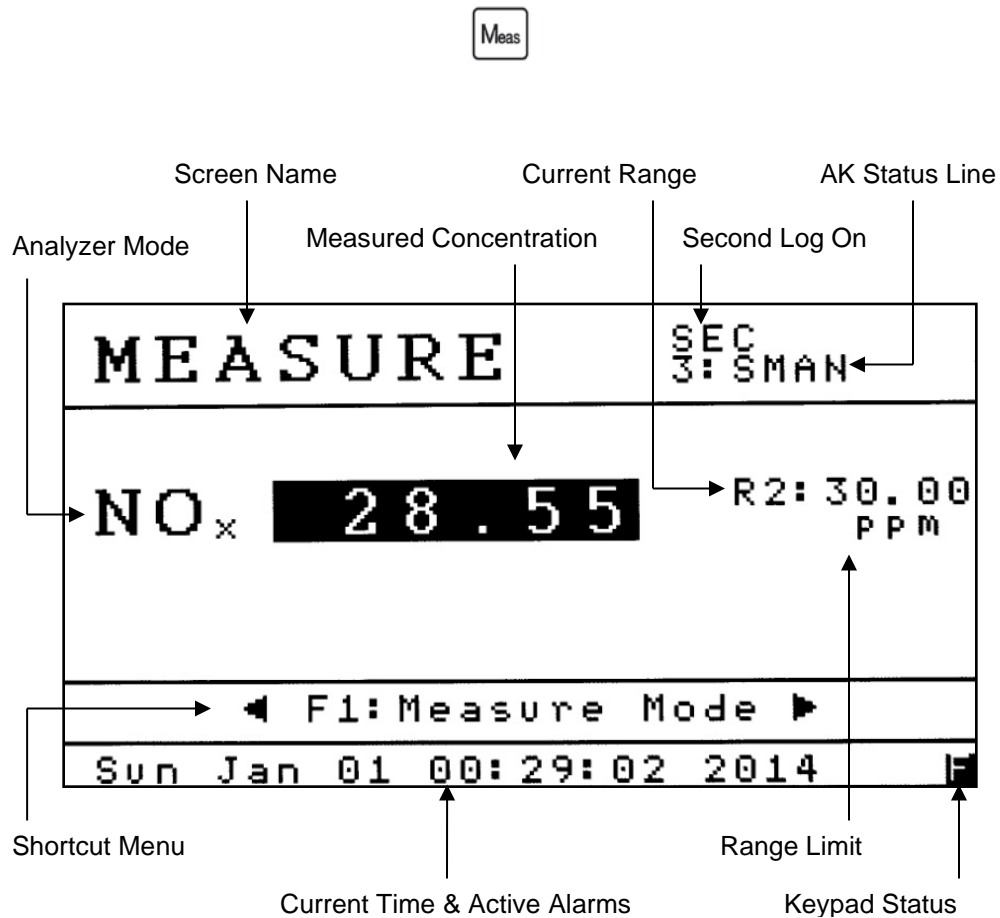
Measure Screen



The Measure Screen provides a visual of the current concentration of the gas being analyzed, along with other pertinent information. The Measure Screen is accessed by pressing the  key. To access the Measure Screen from the Main Menu, press .

Please review the descriptions below (corresponding with the callouts on the illustration above) to familiarize yourself with the Measure Screen.

Screen Name: The name of the active screen the Analyzer is in; in this case the Measure screen.

Second Log On: SEC appears when the second log is enabled. See [Data Logging Time](#).

AK Status Line: When the AK Status line is enabled, it will scroll through the analyzer's present state using AK Protocol. See [AK Protocol](#).

Analyzer Mode: The active mode the analyzer is in (NO, NO_x or NO/NO_x/NO₂).

Measured Concentration: The current concentration that is displayed on the screen.

Current Range: The current range being used by the analyzer. Auto Range is indicated by an A in front of the range number.

Range Limit: The analyzer's full-scale value of the range currently in use.

Current Time/Active Alarms: Scrolls between Time and Date and any active alarms.

Keypad Status: Indicates how the keypad input is currently being used. F is for functions, N is for numeric input.



Up and down arrows are used to change the analyzer's current range.

Shortcut Menu: Scrollable list of shortcut functions available from the Measurement screen. See the shortcuts below:



Left or right arrows are used to scroll through the shortcut menu.



Measure Mode

Allows the operator to change the analyzer's mode to NO, NO_x or NO/NO_x/NO₂.



Raw Values

An advanced diagnostic tool used for troubleshooting.

**F3
3 Diags**

Diagnostic Values is used to view Temperatures, Pressures, EPC Percent Full scale and Flows.

**F4
4 Auto Range**

Allows operators to turn Auto Range On or Off.

**F5
5 Manual Cal**

Allows operators to Zero or Span the analyzer from the Manual Calibration menu.

**F6
6 Menus**

The Menus screen is the starting point for advanced setup and functions.

**F7
7 Standby**

When the analyzer is in Standby mode, it closes all valves and turns off the analyzer's optional sample pump.

**F8
8 Range Limits**

This screen allows operators to customize the analyzer's ranges.

**F9
9 Span Conc**

Operators can change Span gas concentrations for multiple ranges.

**F10
0 NO_x Factors**

Allows operators to set or adjust the NO_x Correction Factors.

Measure Mode

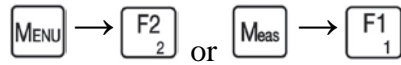

Measure Mode
F1 NO Mode
F2 NO _x Mode
F3 NO/NO _x /NO ₂ Mode

The Measure Mode menu is used to select one of three measurement modes: NO, NO_x or NO/NO_x/NO₂. The Measure Mode menu is accessed by pressing the  key on the Main Menu. This menu will affect how the analyzer operates and what is displayed in the Measure screen.

Press  to set the analyzer in NO only mode.

Press  to set the analyzer in NO_x only mode.

Press  to set the analyzer in NO/NO_x/NO₂ mode.

NO Mode

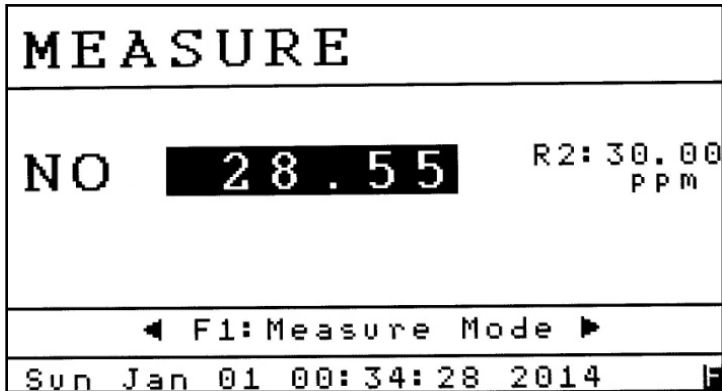

To move to the NO mode, press **F1₁** while in the Measure Mode menu. In NO mode, the sample gas does not pass through the analyzer's NO_x converter. The final reading is NO only.

NO_x Mode

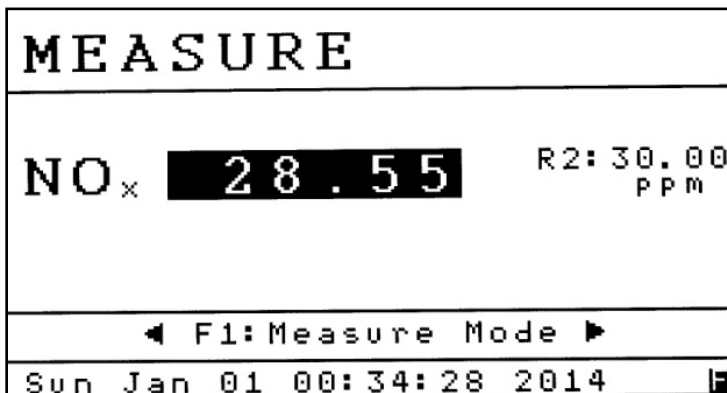

To change to the NO_x mode, press **F2₂** while in the Measure Mode menu. In NO_x mode, the sample gas passes through the NO_x converter and the analyzer measures total NO_x.

NO/NO_x/NO₂ Mode



MEASURE		
NO	- 0 . 0 1	NO
NO _x	- 0 . 0 1	R1: 3.000
NO ₂	0 . 0 0	PPM
◀ F1: Measure Mode ▶		
Sun Jan 01 21:59:56 2003		

The NO/NO_x/NO₂ Mode activates the “sample and hold” feature which allows the analyzer to automatically cycle between NO and NO_x measurement. To change to the

NO/NO_x/NO₂ Mode, press  from the Measure Mode menu. The current measuring mode (cycle) is indicated above the analyzer range. **Example above: NO.**

The cycle times of the sample read are set on the [NO/NO_x/NO₂ Mode Times screen](#). All NO and NO_x readings are displayed as averaged values.

The cycle begins with the NO reading. When the NO reading is completed, the analyzer switches to the NO_x mode (through the converter). When the NO_x cycle is completed, the analyzer updates the averaged NO and NO_x values on the screen and the analog outputs. At that point, the difference between the averaged value of NO and NO_x is calculated as the NO₂ concentration. The cycle continues to repeat.

For advanced calibration and operation in NO/NO_x/NO_x mode, see [NO_x Correction Factors](#).

Analyzer Info



Analyzer Info 192.168.002.092	
Model	700 HCLD
S/N	1304001
Sample Pres	3.85 psi
Air Pres	15.00 psi
Software Version	
NMAIN	7.100
NUSER	7.666
OSMSR	63.024

The Analyzer Info screen contains the basic identity of your 700 Series HCLD

Analyzer. The Analyzer Info screen is accessed by pressing the  key on the Main Menu.

This screen includes the Model and Serial Number of your analyzer (for easy identification if you are discussing your analyzer with CAI), factory settings for sample pressure and air pressure, and the software versions being used. The analyzer's current IP address appears in the upper-right corner of the screen.

Remote/Manual

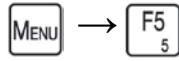

Remote/Manual	SREM
F1 Manual	
F2 Remote	

The Remote/Manual menu gives the operator the ability to control the instrument manually using the keypad or via a remote computer. The Remote/Manual menu is

accessed by pressing the  key on the Main Menu. The current setting (Remote Mode) is displayed in the upper right-hand corner of the screen. **Example: SREM.**

The analyzer can be controlled remotely via:

- TCP/IP Modbus
- RS-232 AK Protocol
- Digital inputs (contact closure) located on the rear of the analyzer.

AK Protocol works with both TCP/IP and Serial. Modbus only works with TCP/IP.

Standby

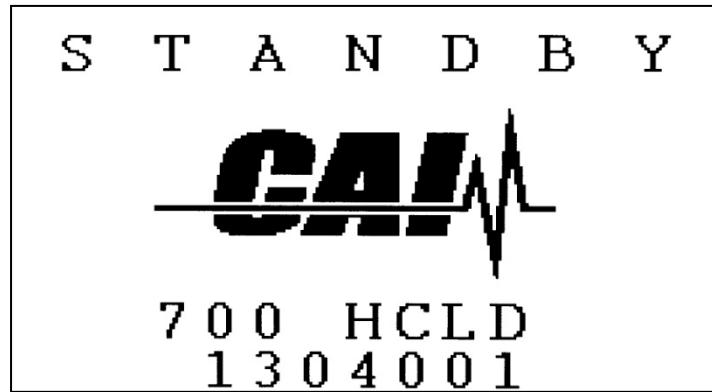
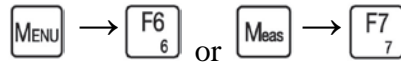

When the analyzer is in Standby Mode, the pump is turned off and the solenoid valves are closed. The CAI logo is displayed along with the Serial Number. Standby mode is accessed by pressing the  key from the Main Menu.

Menus

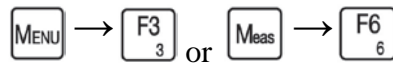



Menus
F1 Calibration
F2 Range Setup
F3 Diagnostics
F4 Setup
F5 Alarms
F6 Service
F7 Security

The Menu screen provides access to most instrument features, including

Calibration, Setup and Diagnostics. From the Main Menu press  to bring up the Menu screen.

Press  to access the Calibration menus.

Press  to access the Range Setup menu.

Press  to access the Diagnostics menus.

Press  to access the Setup menus.

Press  to access the Alarms menu.

Press  to access the Service menu.

Press  to access the Security menu.

Calibration



Calibration
F1 Manual Calibration
F2 Automated Calibration
F3 Cal Gas Concentrations
F4 Calibration Setup
F5 Calibration Factors
F6 Reset Factory Settings

The 700 HCLD Analyzer requires initial calibration with zero and span calibration standards before operation. These calibrations can be performed manually or initiated

automatically. From the Menus screen press  to access the Calibration menu. The Calibration menu includes important features including basic setup for both manual and automated calibration.

Preparing the Analyzer for Calibration

NOTE: If you are changing the analyzer's factory settings, Calibration Setup must be completed prior to your initial calibrations.

From the Calibration menu press  to access the Calibration Setup, or you can use

this menu path to access the [Calibration Setup](#) menu:  →  →  →  .

If you are not making changes to the factory settings, proceed to Manual Calibration.

Manual Calibration

Whether you are calibrating a single range or multiple ranges, each range requires its own complete zero and span calibration. If you are calibrating multiple ranges during one session, the zero calibrations can all be performed before any of the span calibrations, as long as they are within the same relatively short time period. If multiple ranges are used, the calibrations are typically done in ascending order of range. Anytime a zero calibration is performed, a span calibration or check should be done afterward.

The analyzer has two separate manual calibration menus, one for NO or NO_x mode and a second menu for NO/NO_x/NO₂ mode. The analyzer automatically chooses the menu depending on the mode the analyzer is in at the time it enters the Manual Calibration menu.

In NO or NO_x mode, the analyzer has basic zero and span calibration capability in either NO or NO_x mode. In NO/NO_x/NO₂ mode, the analyzer has basic zero and span capability in NO mode and also includes the added NO_x Correction Factor feature. See [NO_x Correction Factors](#) for details.

Manual Calibration

NO or NO_x Mode

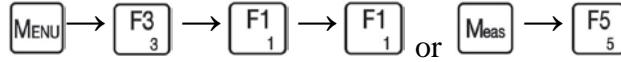

Manual Calibration
F1 Zero
F2 Span

When a manual calibration is performed in Single Mode operation (NO or NO_x mode), the analyzer will remain in that mode during calibration. In Single Mode operation the analyzer can only be calibrated for one mode. The Manual Calibration menu is accessed by pressing F1
1 from the Calibration menu.



Press F1
1 to access the Manual Zero Calibration screen.

Press F2
2 to access the Manual Span Calibration screen.

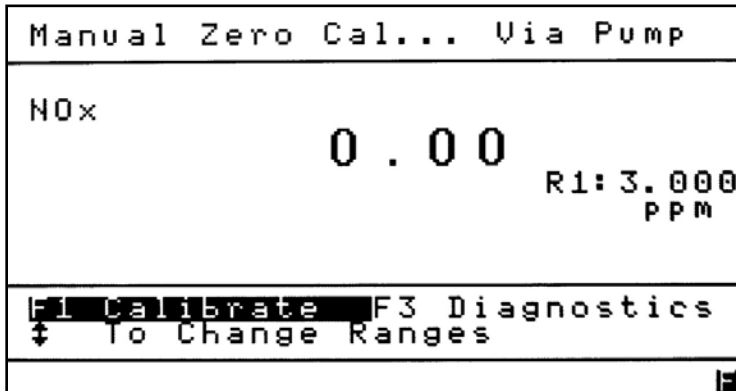

Zero



Zero calibration should be performed before a span calibration. From the Manual Calibration menu press  to access the Manual Zero Calibration screen.

Make sure the analyzer is in the range you wish to calibrate. Use the Up/Down arrows   to go to the desired range. The screen illustration above shows the range (R1) next to the maximum range limit (3.000 ppm).

In the upper-right corner of the screen, you will see a status line that indicates how the calibration gas is being introduced into the analyzer. In this case, (Cal) Via Pump is displayed. The other option is Cal Via Valves. See [Calibration Setup](#) for details.

Introduce zero gas into the rear of the analyzer. Press  to go to the [Diagnostic Values](#) screen to view the current diagnostic values. Check the temperatures and pressures to be sure they are within their limits. If all diagnostic values are within their limits, press the  button to return to the Manual Zero Calibration screen.

When the concentration value has stabilized, press F1
1 to set the zero calibration. The zero portion of the calibration should now be complete.

If the calibration was successful, the screen will say *****Saved Current***** above the concentration value.

Manual Zero Cal... Via Pump	
NOx	***Saved Current***
	0 . 0 0
	R1: 3.000 PPM
F1 Calibrate F3 Diagnostics ↓ To Change Ranges	

Example of a successful calibration.

If the calibration was unsuccessful, the screen will say Outside Deviation Limits.

Manual Zero Cal... Via Pump	
NOx	Outside Deviation Limits
	2 8 . 0 0
	R2: 30.00 PPM
F1 Calibrate F3 Diagnostics ↓ To Change Ranges	

Example of an unsuccessful calibration.

If the zero calibration is unsuccessful, check the following:

1. Make sure the correct gas was introduced into the analyzer.
2. Verify the [Diagnostic Values](#) while flowing gas.
3. Check Zero Gas Deviations under [Manual Deviations](#):

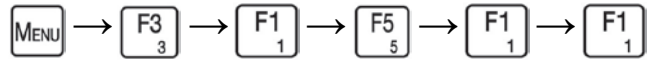

4. Check [Maximum Calibration Error](#) under Calibration Setup:

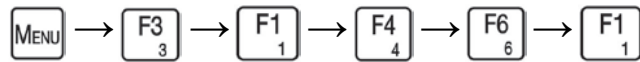

After a successful Manual Zero Calibration, press the  button to return to the Manual Calibration menu.

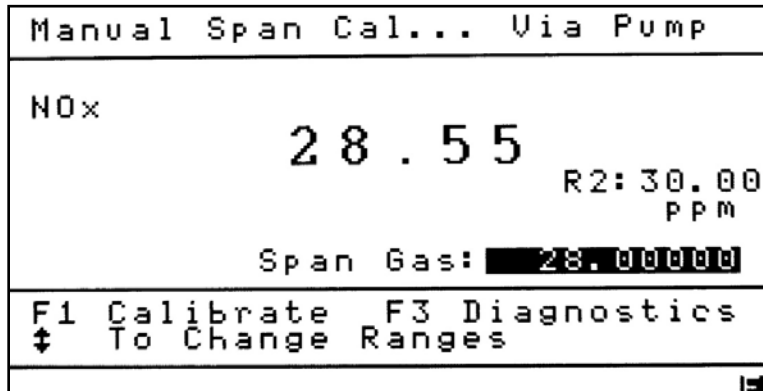

Span



A span calibration should be performed after a successful zero calibration. From the

Manual Calibration menu press  to access the Manual Span Calibration screen.

Make sure the highlighted span gas value (see above) matches the value on the certificate for the span calibration gas being supplied to the analyzer. If the span gas concentration

does not agree with the value on the certificate, press  and change the concentration to match it. Press  again to close the span gas concentration field.

Make sure the analyzer is in the range you wish to calibrate. Use the Up/Down arrows



to go to the desired range. The illustration shows the range (R2) next to the maximum range limit (30.00 ppm).

Introduce span gas into the rear of the analyzer. Press  to go to the [Diagnostic Values](#) screen to view the current diagnostic values. Check the temperatures and pressures to be sure they are within their limits. If all diagnostic values are within their

limits, press the  button to return to the Manual Span Calibration screen.

When the concentration number has stabilized, press  to set the span calibration. The calibration should now be complete.

If the span calibration was successful, the screen will say *****Saved Current*****. If the calibration was unsuccessful, the screen will say **Outside Deviation Limits**. See the [Manual Zero Calibration](#) section for examples of screens showing successful and unsuccessful calibrations.

If the span calibration is unsuccessful, check the following:

1. Make sure the correct gas was introduced into the analyzer.
2. Verify the [Diagnostic Values](#) while flowing gas.
3. Check Span Gas Deviations under [Manual Deviations](#):

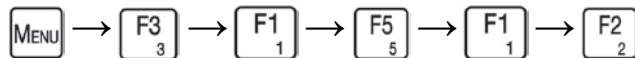

4. Check [Maximum Calibration Error](#) under Calibration Setup:

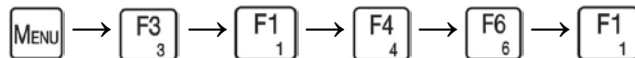

After a successful Manual Zero and Span Calibration, the analyzer is ready for use.

Manual Calibration

NO/NO_x/NO₂ Mode

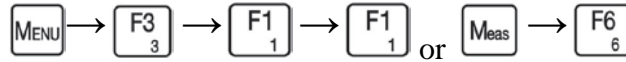

Manual Calibration
F1 Zero NO
F2 Span NO
F5 NO _x Correction Factors

When performing a calibration in Switching mode (NO/NO_x/NO₂ mode), the operator has the option of using basic calibration in NO mode or advanced calibration to create NO_x Correction Factors using NO and NO_x modes. When in Switching mode the Manual Calibration menu can be accessed by pressing F1
1 from the Calibration menu.

Press F1
1 to access the Manual Zero Calibration screen. For details on zero calibration see [Manual Calibration NO or NO_x Mode](#).

Press F2
2 to access the Manual Span Calibration screen. For details on span calibration see [Manual Calibration NO or NO_x Mode](#).

Press F5
5 to access the NO_x Correction Factors menu. For details on advanced calibration see [NO_x Correction Factors](#).

Automated Calibration

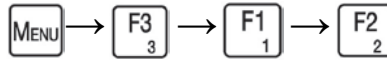

Automated Calibration
F1 Initiate Sequenced Cal
F2 Initiate Sequenced Check

An automated calibration is a timed zero calibration immediately followed by a timed span calibration. The Automated Calibration menu offers two choices: Sequenced Calibration and Sequenced Check of the existing calibration.

The Automated Calibration menu is accessed by pressing  from the Calibration menu. Sequenced means that the flow times of both zero and span gases are controlled using a timer. See [AutoCal Timing](#) located in the Calibration Setup menu.

NOTES:

- An automated calibration should not be attempted before manual zero and span calibrations have been successfully performed.
- If a manually initiated sequenced calibration or sequenced calibration check is selected, it will apply only to the range that is currently in use. (Each additional range must be calibrated separately). This also applies if the analyzer is in auto range.

- This automated calibration is triggered manually and **not** by the analyzer's clock or via remote signal. A fully automated sequenced calibration can be preset to include the desired interval for recurring analyzer-initiated calibrations. This requires additional setup. Automatic calibration of multiple ranges is also possible. See [Calibration Setup](#).
- If a sequenced calibration was unintentionally started, pressing the  button before the Zero step is completed will cancel the calibration.

Initiate Sequenced Cal

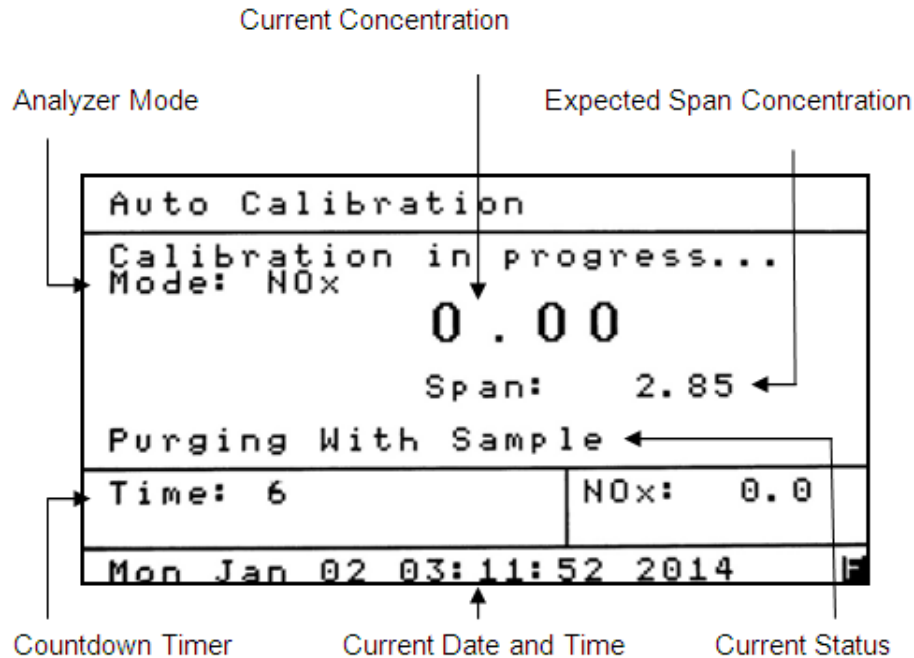

Because of timing requirements, sequenced calibrations are generally used only when the analyzer is controlling the flow of zero and span gases into the analyzer.

To initiate a sequenced calibration, press  from the Automated Calibration menu.

Once the sequenced calibration is initiated, it will calibrate the analyzer in the current mode and range. In this case the NO_x mode is shown near the upper-left corner of the screen.

A sequenced calibration has seven steps. The Current Status of each step is shown just below the expected gas concentration (in this case, it is Purging with Sample). Each step uses a countdown timer set up in [AutoCal Timing](#), located in the Calibration Setup menu. The sequence (with the current range indicated) is as follows:

1. **Zero Range 1 Purging** – Allows time for the zero gas to flush out any residual gases that may still be present in the detection path.
2. **Zero Range 1 Calibrating** – The calculated averaged zero is set as the new offset value, as long as it is within the [Maximum Calibration Error](#) limits.
3. **Zero Range 1 Verifying** – The analyzer verifies that the calibrated zero value has not deviated outside the operator-set allowable [Maximum Verifying Error](#).
4. **Span Range 1 Purging** – Allows time for the span gas to flush out any residual zero gas that may still be present in the detection path.
5. **Span Range 1 Calibrating** – The calculated averaged span is set as the new gain value, as long as it is within the [Maximum Calibration Error](#) limits.
6. **Span Range 1 Verifying** – The analyzer verifies that the calibrated span value has not deviated outside the operator-set allowable [Maximum Verifying Error](#).
7. **Purging With Sample** – Introduces sample gas back into the analyzer and clears out any remaining gases so the current measurements will not be affected by any residual calibration gases.

After these steps, if the calibration is successful, the display will briefly indicate **Calibration Finished** in place of Calibration in Progress at the top of the screen. After a successful calibration is completed, the analyzer will return to the Measure Screen.

If the calibration is unsuccessful, the display will briefly indicate **Could Not Calibrate** in the Current Status line. At the same time, you will be alerted to whether an error occurred in the zero or span portion of the calibration (for example, Span Gas Deviation Error!). The analyzer will then return to the Measure Screen and will revert to the last successful calibration values. A calibration error is set and will remain until cleared by a successful calibration.

To view the verifying zero or span deviations, go to the [AutoCal Deviations](#) menu under Calibration Factors. To view or change the maximum allowable calibration tolerances, see [Deviation Limits](#).

Initiate Sequenced Check



Auto Calibration	
Cal Check in progress...	
Mode: NOx	
28.55	
Span: 28.00	
Purging With Sample	
Time: 8	NOx: 28.6
Sun Jan 01 00:42:41 2014	

Initiate Sequenced Check is a useful tool for setting up **Auto Calibration**. From the Auto Calibration Menu screen, pressing  initiates a sequenced calibration **check**. Rather than initiating a calibration, it checks the validity of your most current calibration.

A sequenced calibration check performs all of the steps of a sequenced calibration with the exception of the zero and span **calibrations**. It does not set new offsets, gains or any alarms.

Cal Gas Concentrations

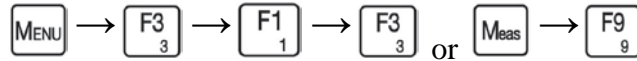

Cal Gas Concentrations		
NOx	Gas Value	Range
Range 1	2.850	3.00
Range 2	28.000	30.00
Range 3	285.000	300.00
Range 4	2870.000	3000.00
F1 SAVE		

The Cal Gas Concentrations screen allows operators to change calibration gas values for multiple ranges on one screen. To access the Cal Gas Concentrations screen

(shown above) press from the Calibration Menu.

The Cal Gas Concentrations screen displays the range identification, the changeable span gas value and the full-scale value set for that range.

Using the Up/Down arrows move the highlighted field to the span gas value you wish to change (for example, 2.850 above). Press to open the span gas value field and change the value to match the span gas being supplied to the analyzer. Press again to close the span gas value field. Press to save the changes.

Calibration Setup

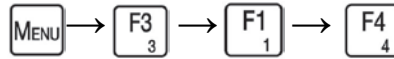

Calibration Setup	
F1	Autocal Schedule
F2	AutoCal Parameters
F3	Cal Pump/Valves... Valves
F4	Auto Cal/Check... Check
F5	AutoCal Timing
F6	Deviation Limits
F7	Analog Hold On Cal... On

The Calibration Setup menu provides all the parameters necessary for completing a successful calibration. To access the Calibration Setup menu, select  from the Calibration menu.





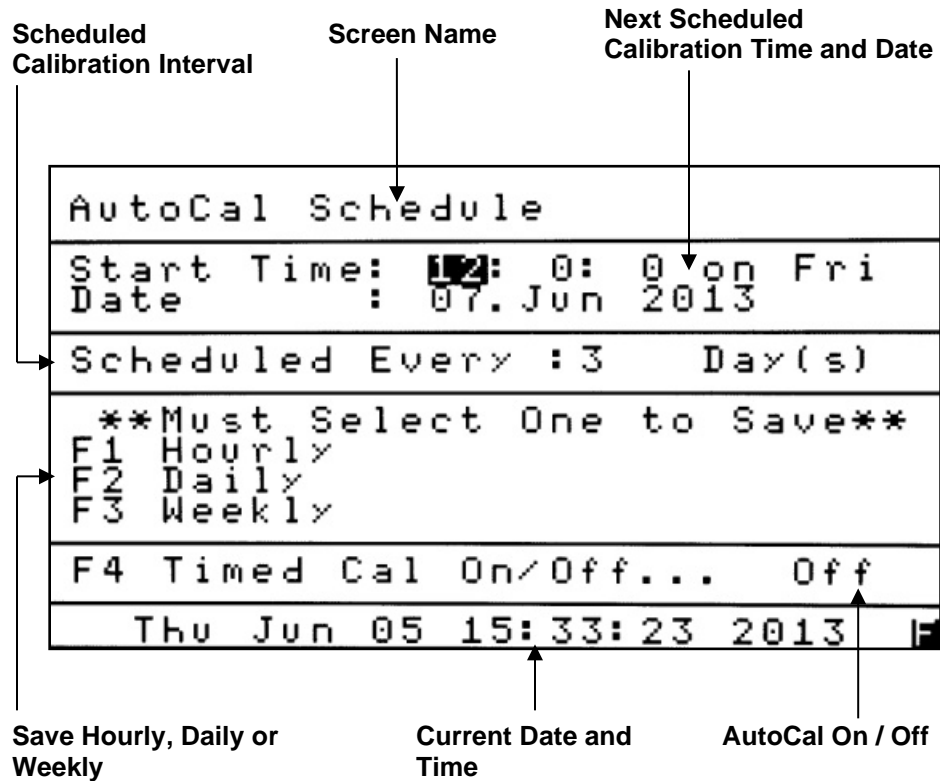

All parameters on the Calibration Setup menu apply to Automated Calibration. The following also apply to Manual Calibration: Cal Pump/Valves, Auto Cal/Check, Deviation Limits and Analog Hold on Cal. All settings should be verified for correct information before a manual or automated calibration is attempted.



Please note that the Calibration Setup menu shows the current settings on the right side of the screen after the ellipsis (...). Example: **Cal Pump/Valves . . . Valves.**





Auto Calibration Schedule



The Auto Calibration Schedule screen allows the operator to run automated calibrations using the analyzer's internal clock. In addition to the Start Time and Date, the Scheduled Calibration interval (in the example, scheduled every 3 days) can be changed by the operator. The Auto Calibrations screen is accessed by pressing  from the Calibration Setup menu.

Use the arrow buttons     to move the highlight to changeable fields (in the example, Start Time: **12**). Press  to open the field and change the value. Press  again to close the field after you have made your changes.

After all the changes have been made, you **must** choose one of the following: 
 (Hourly),  (Daily) or  (Weekly) to save your changes. **If this is not done**, the selected changes will not be made and the analyzer will revert to the previous settings.

To change Timed Auto Calibration to on or off, press  (Timed Cal On/Off). A submenu will open with two choices. Press  to turn Timed Cal On, or press  to turn Timed Cal Off. Selecting  or  will bring you back to the AutoCal Schedule screen. The current setting is shown on the right side of the menu after the ellipsis (. . .). In the example, **Timed Cal On/Off . . . Off**.





Auto Calibration Parameters









AutoCal Parameters	
Select 0 for all ranges	
Range [0 - 4]...	1
Mode...	NO
Cal Gases...	All
F1 SAVE	





Auto Calibration Parameters allows the operator to select the range, mode and choose between **Zero and All** calibration gases (both zero and span). To access the

AutoCal Parameters screen, press  from the Calibration Setup menu.

To navigate between parameters, use the up or down arrow   to move the highlight to the field you intend to change. Press  to open the field and change the parameter. Press  again to close the field after you have made your change.

The first changeable parameter is the Range to be calibrated. Press  to open the field and change the range. Then select a range (from 1 – 4) for calibration. To select all ranges, press 0. Press  to close the field.

The second parameter the operator can change is the Mode. The 700 HCLD analyzer can calibrate in either NO or NO_x mode. Press  to open the field and select the mode using the up/down arrows  . Press  to close the field.

Calibration Gases gives you a choice of calibrating with Zero gas only or All calibration gases (zero and span gases). Press  to open the field and change the parameter using the up or down arrows  . Press  to close the field.

Press  to save your settings. Once your changes have been saved, the analyzer will return you to the Calibration Setup menu.

Calibration Via Pump/Valves

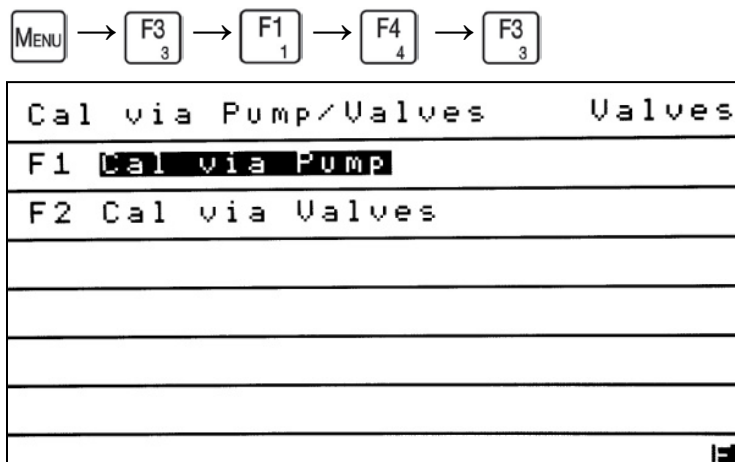

The use of Cal via Pump/Valves depends upon how calibration gases are being introduced into the analyzer – via a sample pump or internal valves (if equipped with the internal valve option). The existing setting (Valves in the example) is shown at the top right of the menu. To access the Cal via Pump/Valves menu, press  from the Calibration Setup menu.

Press  (Cal via Pump) to keep the analyzer’s internal sample pump on and keep the valves closed during calibration. You will return to the Calibration Setup Menu. Please note that the Calibration Setup menu will display the current settings on the right side of the screen after the ellipsis (...). **Example: Cal Pump/Valves . . . Pump.**

NOTE: If the analyzer is equipped with a pump, to prevent damage to the pump do not pressurize the sample inlet.

Press  (Cal via Valves) to activate the appropriate calibration valve and keep the internal sample pump turned off during calibration. Keeping the sample pump turned off while the valves are activated will prevent sample from being mixed with calibration gas. You will return to the Calibration Setup Menu. Please note that the Calibration Setup menu shows the current settings on the right side of the screen after the ellipsis (...).

Example: Cal Pump/Valves . . . Valves.

Auto Calibration/Check



Set Auto Cal/Check	Check
F1 Set Auto Cal to Calibrate	
F2 Set Auto Cal to Check	

Auto Calibration/Check lets the operator select whether the analyzer actually calibrates, or performs a check of the calibration. To access the Auto Cal/Check

menu, press  from the Calibration Setup menu. The current setting is shown on the upper-right corner of the screen.

Press  to set the analyzer parameter to Calibrate. This setting will be saved and the analyzer will return to the Calibration Setup menu. The Calibration Setup menu shows the current setting on the right side of the screen after the ellipsis (. . .).

Example: Auto Cal/Check . . . Cal.

Press  to set the analyzer parameter to Check. The setting will be saved and the analyzer will return to the Calibration Setup menu. The Calibration Setup menu shows the current setting on the right side of the screen after the ellipsis (. . .).

Example: Auto Cal/Check . . . Check.





Auto Calibration Timing



AutoCal Timing [sec]		
Purge Before...		10
Calibrating		10
Verifying...		10
Purge After...		10
Zero	Span	Total
30	30	70
F1 SAVE		

Auto Calibration Timing determines the length of time it takes the analyzer to perform the Zero and Span cycles during a sequenced auto calibration. To access the

AutoCal Timing screen, press  from the Calibration Setup menu. All values on the screen are expressed in seconds.

To navigate between parameters, use the up or down arrow   to move the highlight to the field you intend to change. Press  to open the field and change the value (seconds). Press  again to close the field after you have made your change.

A sequenced auto calibration consists of two cycles: Zero and Span. In both cases, the cycle duration is equal to the sum of the Purge Before, Calibration and Verification times. The Total Auto Calibration time is equal to the sum of the Zero and Span cycle times plus the Purge After time. See the example above.

- 1. Purge Before:** the operator can set the amount of time necessary to flush the analyzer with calibration gases. This will ensure that there are no other gases remaining in the analyzer during the calibration process.
- 2. Calibrating Time:** during this 10-second time, the analyzer will calculate new offset and gain factors. The calibrating time is factory-set at 10 seconds and cannot be changed by the operator.
- 3. Verifying Time:** during this time the measured value is checked to make sure it does not deviate outside the upper or lower limit specified by the [Maximum Verifying Error](#). The verifying time is typically set for 10 seconds.
- 4. Purge After:** the operator can set the time needed to flush any remaining calibration gases out of the analyzer before the In Cal Status is released and the measurement status is set.

After the Auto Calibration Timing has been set, press  to save the changes.

Deviation Limits



Deviation Limits
F1 Maximum Calibration Error
F2 Maximum Verifying Error

Deviation Limits are used by the operator to define the maximum acceptable error limits of the zero and span gases for both manual and sequenced calibration. To

access the Deviation Limits menu, press  from the Calibration Setup menu.

Press  to set or view the Maximum Calibration Error Limits.

Press  to set or view the Maximum Verifying Error Limits.

Maximum Calibration Error

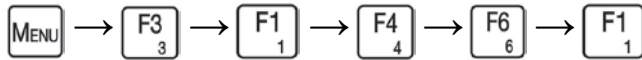

Maximum Calibration Error [%]		
Range	Absolute	Relative
Range 1	10.00	10.00
Range 2	10.00	10.00
Range 3	10.00	10.00
Range 4	10.00	10.00
F1 SAVE		

Maximum Calibration Error is used by the operator to define the maximum acceptable tolerances for Absolute and Relative deviations. Each range has its own set of Absolute and Relative tolerances. The deviations must be inside these tolerances for the analyzer to accept a calibration. To access the Maximum Calibration Error screen, press from the Deviation Limits menu.

To navigate between fields, use the up or down arrow to move the highlight to the field you intend to change. Press to open the field to change the allowable tolerance in %. Press again to close the field. Press to save your changes.

Absolute Deviation is used to compare the factory-set calibration to the current calibration.



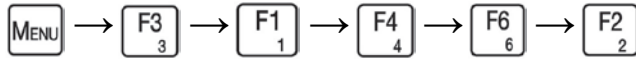

Relative Deviation compares the current calibration to the previous calibration.

Maximum Verifying Error



Maximum Verifying Error [%]	
Range	Allowable
Range 1	1.00
Range 2	1.00
Range 3	1.00
Range 4	1.00
F1 SAVE	

Maximum Verifying Error is the allowable tolerance during the Verifying step of sequenced calibration. To access the Maximum Verifying Error screen, press  from the Deviation Limits menu.

To set the allowable tolerances for different ranges, use the up or down arrow   to move the highlight to the field you intend to change. Press  to open the field to change the value in %. Press  again to close the field. Press  to save your changes.

Analog Hold on Cal



Analog Hold On Cal	Off
F1 Analog Hold On	
F2 Analog Hold Off	

Analog Hold on Cal will hold the analog outputs to the last measured value during calibration. If Analog Hold on Cal is Off the analog outputs will be live. The existing setting (**Off**) is shown at the top right of the menu. To access the Analog Hold on Cal

menu, press  from the Calibration Setup menu.

From the Analog Hold On Cal menu, press  to turn Analog Hold On, which will hold the analog outputs at the last measured value. You will return to the Calibration Setup menu. The Calibration Setup menu shows the current setting at the bottom-right corner of the screen after the ellipsis (. . .).

Example: Analog Hold on Cal . . . On.

From the Analog Hold On Cal menu, press  to turn Analog Hold Off. You will return to the Calibration Setup menu. The Calibration Setup menu shows the current setting at the bottom-right corner of the screen after the ellipsis (. . .).

Example: Analog Hold on Cal . . . Off.

Calibration Factors

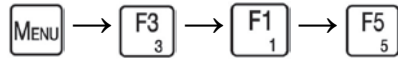

Calibration Factors
F1 Manual Deviations
F2 Auto Cal Deviations
F3 Offset/Gain Factors

Calibration Factors allow the operator to track and view changes from the factory and previous calibrations. To access the Calibration Factors menu, press  from the Calibration menu.

Press  to view the Manual Calibration Deviations menu.

Press  to view the Auto Calibration Deviations menu.

Press  to access the Offset and Gain Factors screen.

Zero Gas Deviations

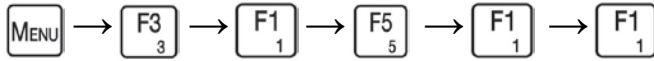

Zero Gas Deviations [%]		
NOx	Abs	Rel
Range 1	0.00	0.00
Range 2	0.00	0.00
Range 3	0.00	0.17
Range 4	0.00	0.00

Press  from the Manual Deviations menu to view the Zero Gas Deviations screen.

Absolute Zero Gas Deviation is the zero gas content calculated by the factory polynomial related to the calibrated range limit.

Relative Zero Gas Deviation is the current deviation minus the deviation of the previous calibration related to the calibrated range limit.

Span Gas Deviations

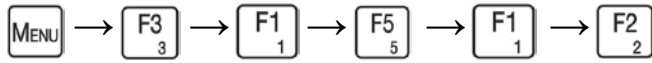

Span Gas Deviations [%]		
NOx	Abs	Rel
Range 1	0.00	0.00
Range 2	-1.84	0.00
Range 3	0.00	0.00
Range 4	0.00	0.00

Press  from the Manual Deviations menu to view the Span Gas Deviations screen.

Absolute Span Gas Deviation is span gas bottle value minus span gas value calculated by the factory polynomial related to the calibrated range limit.

Relative Span Gas Deviation is the current deviation minus the deviation of the previous calibration.

Auto Cal Deviations



Auto Cal Deviations
F1 Verifying Zero Devs
F2 Verifying Span Devs

The Auto Calibration Deviations menu gives the operator a choice of viewing either zero or span verifying deviations. The verifying deviations are taken during the verifying stage of sequenced and auto calibrations. Press  from the Calibration Factors menu to access the Auto Cal Deviations menu.

Press  to view the Verifying Zero Deviations screen.

Press  to view the Verifying Span Deviations screen.

Verifying Zero Deviations

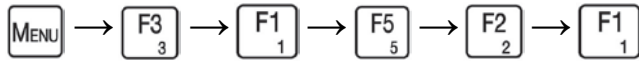

Verifying Zero Deviation			
NOx	Meas	Var	%FS
R1	0.0	0.00	0.00
R2	0.0	0.00	0.00
R3	0.0	0.00	0.00
R4	0.0	0.00	0.00

Press  from the Auto Cal Deviations menu to view the Verifying Zero Deviations screen.

Measured Value is the averaged concentration during the Verifying Zero stage of sequenced and auto calibrations.

Variance is the difference of the measured value and zero.

% FS is the percent of full scale related to the calibrated range limit.

Verifying Span Deviations

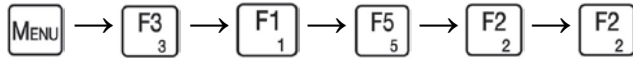

Verifying Span Deviation			
NOx	Meas	Var	%FS
R1	0.0	0.00	0.00
R2	0.0	0.00	0.00
R3	0.0	0.00	0.00
R4	0.0	0.00	0.00

Press  from the Auto Cal Deviations menu to view the Verifying Span Deviations screen.

Measured Value is the averaged concentration during the Verifying Span stage of sequenced and auto calibrations.

Variance is the difference of the measured value and span gas concentration.

% FS is the percent of full scale related to the calibrated range limit.

Offset/Gain Factors



Offset/Gain Factors		
NOx	Offset	Gain
Range 1	0.00	1.00
Range 2	-0.00	1.00
Range 3	0.00	1.00
Range 4	0.00	1.00

When used in conjunction with the Manual Calibration Deviations, an increasing or decreasing change in Offset or Gain will provide insight into changes in analyzer

performance. Press  from the Calibration Factors menu to access the Offset/Gain Factors screen.

Offset is the difference between factory zero and the value stored during zero calibration.

Gain is the value stored during span gas calibration using the operator-defined calibration gas.

Reset Factory Settings

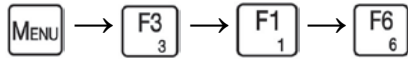

Reset Factory Settings
F1 Reset Offsets and Gains
F2 Reset Linear Coefficients

The Reset Factory Settings menu gives the operator a choice of resetting the Offsets and Gains, or both Factory Linear Coefficients and Offsets and Gains for all calibrated ranges. Resetting factory settings will not affect any other operator-changed parameters.

Press  to reset the Offsets and Gains.

Press  to reset the Linear Coefficients, Offsets and Gains and NO_x Factors.

Reset Offsets and Gains

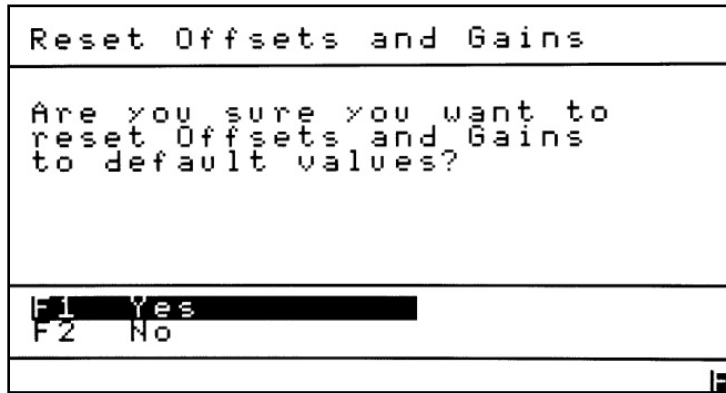

Pressing **F1₁** from the Reset Factory Settings menu will prompt the operator to confirm resetting Offsets and Gains for all ranges. Pressing **F1₁** (Yes) from this screen resets the Offset and Gain factors to factory default settings (0 and 1 respectively) and brings you to this confirmation screen:

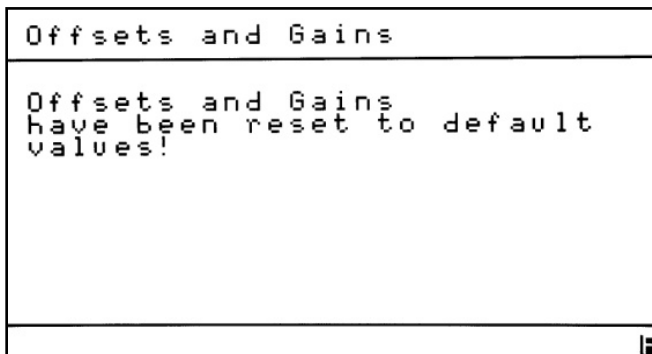

- Offset and Gain factors are created when the analyzer is zeroed and spanned.
- If the Offsets and Gains are reset, the analyzer must be zeroed and spanned again before use.
- All recorded deviations will be set to zero.

If you press **F2₂** (No) from the Reset Offsets and Gains screen, the analyzer will return to the Reset Factory Settings menu without resetting the Offsets and Gains.

Reset Linear Coefficients



Reset Linear Coefficients	
Are you sure you want to reset Linear Coefficients to default values?	
F1	Yes
F2	No

Pressing **F2**₂ from the Reset Factory Settings menu will prompt the operator to confirm resetting the Linear Coefficients for all ranges. Pressing **F1**₁ (Yes) from this screen resets all the **Linear Coefficients, Offset and Gain Factors and NO_x Correction Factors** to factory default settings and brings you to this confirmation screen:

Linear Coefficients
Linear Coefficients have been reset to default values!

NOTE: After resetting Linear Coefficients, the analyzer must be zeroed and spanned before further use.

If you press **F2**₂ (No) from the Reset Linear Coefficients screen, the analyzer will return to the Reset Factory Settings menu without resetting the Linear Coefficients, Offsets and Gains Factors or NO_x Correction Factors.

Range Setup



Range Setup	
F1	Range Limits
F2	AutoRange... Off
F3	AutoRange Switch Points

Range Setup allows the operator to change Range Limits, turn Auto Range On or

Off, and change Auto Range Switch Points. From the Menus screen press  to access the Range Setup menu.

Press  to view or change Range Limits.

Press  to access the Auto Range On/Off menu. In either case, you will return to the Range Setup menu. The Range Setup menu shows the current status on the right side of the screen after the ellipsis (...). **Example: AutoRange On/Off. . . Off.**





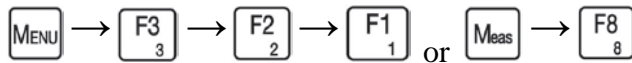

Press  to view or change Auto Range Switch Points.

Range Limits



Range Limits	
Must be Ascending	
Range 1	0.00
Range 2	30.00
Range 3	300.00
Range 4	3000.00
Maximum Range Limit 3000.0	
F1 SAVE	

The analyzer is factory-configured with four physical ranges (1 - 4). The operator can change the number of ranges and select a specific full-scale concentration in ppm. From the Range Setup menu press  to access the Range Limits screen.

To change the Range Limits from the factory settings, use the up or down arrows   to move the highlight to the field you intend to change. Press  to open the field to change the value in ppm. Press  again to close the field. Press  to save your changes. To initiate the saved changes, press , then press  and select new ranges.

NOTES:

1. The Range Limit values must be set in ascending order.
2. The analyzer will not allow any of the range limits to exceed the maximum range limit on the Range Limits screen. **Example: Maximum Range Limit 3000.0.**
3. To set a single range, set Range 1 to the desired value and all others to zero.

4. To set two ranges, set Range 1 to the lowest value, Range 2 to the highest value, and the others to zero.
5. If new ranges are saved, the Auto Range Switch Points will be set to default percentages of range limits. See [Auto Range Switch Points](#).

Auto Range On/Off

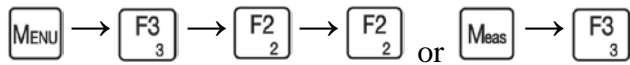

AutoRange	Off
F1	AutoRange On
F2	AutoRange Off

The Auto Range Function allows the analyzer to automatically switch up and down between ranges at predetermined concentrations. From the Range Setup menu press  to access the Auto Range On/Off screen. The current Auto Range status appears in the upper-right corner of the screen.

Press  to turn Auto Range On. This function allows the analyzer to automatically change ranges without the presence of an operator.

Press  to turn Auto Range Off. When Auto Range is Off, the operator will need to manually change the ranges. The Range Setup menu shows the current status on the right side of the screen after the ellipsis (...). **Example: AutoRange On/Off. . . Off.**

Auto Range Switch Points

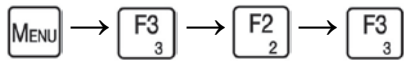

AutoRange Switch Points		
Range	Down	Up
Range 1		2.70
Range 2	2.43	27.00
Range 3	24.30	270.00
Range 4	243.00	
F1 SAVE		
F2 Default Switch Points		

Auto Range Switch Points determine when the analyzer automatically changes a range up or down when the Auto Range function is turned on. From the Range Setup

menu press to access the Auto Range Switch Points screen.

The Default Switch Points are created by the range limits. The Up Switch Point is 90% of the Range Limit. The Down Switch Point is 90% of the previous range's Up Switch Point.

To change the Auto Range Switch Points, use the up/down arrows to move the highlight to the field you intend to change. Press to open the field to change the value in ppm. Press again to close the field. Press to save your changes. To initiate the saved changes, press , then press and select new Auto Range Switch Points.

In the example above, if the Range 1 concentration reaches 2.70 ppm, the analyzer will switch to Range 2. If the concentration for Range 2 gets as low as 2.43 ppm, the analyzer will switch to Range 1.

Diagnostics



Diagnostics	
F1	Diagnostic Values
F2	Raw Value Display
F3	I/O Status
F4	Status Line... OFF

The Diagnostics menu allows the operator to access key troubleshooting screens including Diagnostic Values, Raw Values and Input/Output statuses. From the

Menus screen press  to access the Diagnostics menu.

Press  to access the Diagnostic Values screen. It allows you to check analyzer temperatures, pressures, EPC voltage percentages and flows.

Press  to access the Raw Values Display menu.

Press  to access the I/O Status menu. You can check the status (Open or Closed) of the analyzer's digital outputs and inputs.

Press  to turn On or Off the AK Status Line. The current setting is shown on the Diagnostics menu on the right side of the screen after the ellipsis (...). **Example: Status Line. . . Off.**

Diagnostic Values

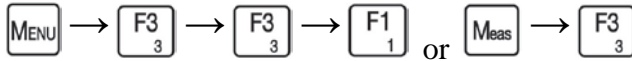



Temperatures Screen

Temperatures [°C]			
Device	Value	LoLimit	HiLimit
Diode	-4.99	-5.50	-4.50
Cell	66.00	65.00	69.00
Conv.	204.9	204.00	210.00
Oven	85.00	84.00	88.00
Pump	85.00	84.00	102.00
Dryer	4.00	-2.00	7.00
Case	25.4		

Use ◀ ▶ keys to scroll
 Temps Press EPC Flows

The Diagnostic Values screens allow the operator to check analyzer temperatures, sample and air pressures, EPC voltage percentages and flows. These important screens are accessed by pressing  from the Diagnostics menu.

The first screen that appears is the Temperatures screen. The Temperatures screen displays the current temperature and low and high alarm limits for key analyzer components.

As indicated at the bottom of the screen, use the left and right arrow keys   to scroll to different screens. The current screen will be highlighted (Temps in the example).

The Temperatures, Pressures and EPC Voltage Percent screens include the current device Values and the Low and High Alarm Limits. For example, if the analyzer's diode temperature drops lower than -5.50°C or exceeds -4.50°C, an alarm will be triggered and displayed at the bottom of the [Measure Screen](#).

Pressures Screen

Pressures [PSIG]			
Device	Value	LoLimit	HiLimit
Sample	3.85	3.80	3.90
Air	14.98	14.00	16.00

Use ◀ ▶ keys to scroll
 Temps Press EPC Flows

The Pressures screen displays current sample and air pressures and low and high alarm limits in PSIG.

EPC Voltage Percent Screen

EPC Voltage [%]			
Device	Value	LoLimit	HiLimit
Sample	30	10	85
Air	40	10	85

Use ◀ ▶ keys to scroll
 Temps Press EPC Flows

The EPC screen displays the percentage of EPC voltage being supplied to the EPC valve.

Flows Screen

Flows [mL/Min]	
Device	Value
Sample	49.0
Air	356.4

Use ◀ ▶ keys to scroll
 Temps Press EPC Flows

The Flows screen displays the current flow of sample and air in mL/minute. It does **not** include an alarm function because flows are calculated values based on the pressures.

Raw Values Display

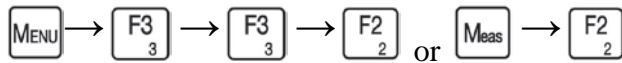

NOx Raw Values	Raw Volts
F1 Mode...NOx	0.500
F2 Alarms	Raw Conc.
F3 Diagnostics	-0.01
F4 Flow Zero	Meas Conc.
F5 Flow Span	-0.01
	Meas
⚡ Range Up/Down	AR1: 3.000

The Raw Values Display screen is a diagnostic tool for viewing detector Raw Volts and Calculated Concentrations. This screen is accessed by pressing  from the Diagnostics menu.



Raw Voltage: This is a 0.512 VDC to 4.512 VDC that will be digitized by the microprocessor to generate the calibration curve from which the Raw Concentration and Measured Concentration are derived. The 0.512 volts is equal to 0 ppm and 4.512 is equal to the four factory-set range limits. (**Example of standard analyzer range limits: 3, 30, 300 and 3000.**)

Raw Concentration: This value (in ppm) is calculated from the Raw Volts before linearization and offset and span corrections are applied.

Measured Concentration: This value (in ppm) is calculated from the Raw Concentration. Then linearization, offset and span corrections are applied.

From the Raw Values Display screen, the following functions can be useful for diagnosing and monitoring the analyzer's performance:

Press  to change the analyzer's mode to NO or NO_x. If the analyzer is in NO/NO_x/NO₂ mode it will continue to switch between NO and NO_x. The current mode is indicated after the ellipsis (...). **Example: Mode. . . NO_x.**

Press  to access the [Current Alarms](#) screen. Press  to return to the Raw Values Display screen.

Press  to view the [Diagnostic Values](#) screens.

Press  to open the Zero valve (if your analyzer is equipped with optional calibration valves). **Zero** will be indicated above the range (at the bottom right of the screen). To return to the Measure mode, press F4 again. **Meas** will be indicated above the range on the screen.

Press  to open the Span valve (if your analyzer is equipped with optional calibration valves). **Span** will be indicated above the range (at the bottom right of the screen). To return to the Measure mode, press F4 again. **Meas** will be indicated above the range on the screen.

To change ranges, use the Up/Down arrows  . The current range is shown in the bottom-right corner. **Example: R1: 3.000.**

If the analyzer's AutoRange function is turned On, the operator will not be able to manually change ranges until AutoRange is turned Off. When AutoRange is turned On, it is indicated with an **A** before the range: **Example: AR1: 3.000.**

I/O Status

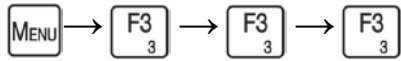



I/O Status
F1 Analyzer Digital Outputs
F2 Analyzer Digital Inputs
F3 Programmable Digital Out

The I/O Status menu gives the operator a choice of viewing the statuses of the analyzer's digital outputs or digital inputs (open or closed). To access the I/O Status

menu, press  from the Diagnostics menu.

Press  to view the status of the analyzer's standard digital outputs.

Press  to view the status of the analyzer's digital inputs.

Press  to view the status of the Programmable Digital Outputs.

Analyzer Digital Outputs

MENU →
 F3
3 →
 F3
3 →
 F3
3 →
 F1
1

Analyzer Digital Outputs		
Pin	Function	Status
M7	AutoRange	Open
M8	Range 1	Open
M9	Range 2	Open
M10	Range 3	Open
M11	Range 4	Closed
M22	Zero Gas	Open
M23	Span Gas	Closed
M24	Sample Gas	Open
M25	In Remote	Closed
M26	In Calib.	Closed

The Analyzer Digital Outputs screen allows the operator to view the status of an analyzer output (Open or Closed) and where to find the corresponding pin number.

To access the Analyzer Digital Outputs status screen, press F1
1 from the I/O Status menu.

The Pin column indicates the connector and the pin number that are used to control the digital output function. **In the example (M7)**, M is the Main Connector on the analyzer's back panel, and 7 is the Pin Number on that connector.

The **Status** becomes closed when the function is true. In the example above, the analyzer is in Range 4. Range 4's status is closed. This will result in a closed contact to digital ground. It can be measured from the Main Connector Pin 6 (digital ground) to the Main Connector Pin 11.

NOTE: These analyzer functions are not user-changeable and have static pinouts. These screens are for viewing only.

Analyzer Digital Inputs

Analyzer Digital Inputs		
Pin	Function	Status
M12	AutoRange	Open
M13	Range1	Open
M14	Range2	Open
M15	Range3	Open
M16	Range4	Open
M17	AutoCal	Open
M18	CalCheck	Open
M19	Zero	Open
M20	Span	Open

Next page Page 1

The Analyzer Digital Inputs screen allows the operator to view the status of an analyzer input (Open or Closed) and where to find the corresponding pin number.

To access the Analyzer Digital Inputs status screen, press from the I/O Status menu.

As indicated at the bottom of the screen, press the left and right arrow buttons to scroll to different Analyzer Digital Input screens.

The Pin column indicates the connector and the pin number that are used to control the function. **In the example (M12)**, **M** is the Main Connector on the analyzer's back panel, and **12** is the Pin Number on that connector. The abbreviations are as follows:

M = Main Connector

A = Auxiliary

Int = Internal, for CAI use only.

When the analyzer is in Remote Mode and the digital input is pulled to digital ground (Main Connector, Pin 6), the status will become Closed.

NOTE: These analyzer functions are not user-changeable and have static pinouts. These screens are for viewing only.



Programmable Digital Outputs



Programmable Digital Outputs				
AUX Pin	DO	Function	Status	
5 to 9	1	Samp P	Closed	
5 to 10	2	Off	Open	
5 to 11	3	Off	Open	
5 to 12	4	Off	Open	
6 to 13	5	Off	Open	
6 to 14	6	Off	Open	
6 to 15	7	Off	Open	
6 to 16	8	Off	Open	
Next page ▶		Page 1		

The Programmable Digital Outputs screen allows the operator to check the status of the analyzer's programmable digital outputs (Open or Closed) according to pin

numbers and programmed functions. From the I/O Status menu, press  to view Programmable Digital Output statuses.

As indicated at the bottom of the screen, press the left and right arrow buttons   to view the next or previous page of Programmable Digital Output statuses.

The column key is as follows:

Aux Pin = Auxiliary connector on the back panel and pin number on the connector

DO = Programmable digital output number

Function = Operator-programmed function

Status = The state the programmed relay is in (open or closed)

NOTES:

- To set functions, see [Programmable Digitals](#).
- Programmed statuses are closed when true.
- Programmed alarms are open when true.

Status Line

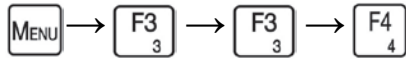

Status Line	OFF
F1	Turn Status Line On
F2	Turn Status Line Off

The AK Command Status Line can be displayed at the top of the Measure Screen.

This field contains the current AK Protocol information. See [AK Protocol](#). The current status is shown in the upper-right corner of the Status Line menu. **Example above: OFF.**

From the Diagnostics menu, press  to select On or Off.

Press  from the Status Line menu to turn the AK Status Line On.

Press  from the Status Line menu to turn the AK Status Line Off.

Example of the Status Line turned on: **3: SMAN**

MEASURE	3: SMAN
NO _x 28.55	R2: 30.00 PPM
◀ F1: Measure Mode ▶	
Sun Jan 01 00:29:02 2014	

Setup Menu





Setup
F1 Measure Settings
F2 Output Settings
F3 TCP/IP Parameters
F4 Data Logging Time
F5 Auto Start Settings
F6 Clock

The Setup menu provides access to key setup screens including Measure Settings,

Output Settings and TCP/IP Parameters. From the Menus screen press  to access the Setup menu.

Press  to access the Measure Settings menu. These setup screens allow the operator to view or change averaging times, NO/NO_x/NO₂ mode times and NO_x correction factors.

Press  to access the Output Settings menu. The Programmable Analog and Programmable Digital outputs can be viewed or set up to fit the operator's needs.

Press  to view or change the current TCP/IP parameters.

Press  to access the Data Logging Time screen. (For CAI use only.)

Press  to view or make changes to the Auto Start Settings.

Press  to view or change the analyzer's time and date.

Measure Settings

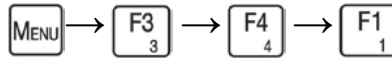

Measure Settings
F1 Averaging Time
F2 NO/NO _x /NO ₂ Mode Times
F3 NO _x Correction Factors

The Measure Settings menu provides access to the following Setup parameters:

Averaging Time, NO/NO_x/NO₂ Mode Times and NO_x Correction Factors. The

Measure Settings menu is accessed by pressing  from the Setup menu.

Press  to view or change the Averaging Time of the measured concentration.

Press  to view or change NO/NO_x/NO₂ mode switching times.

Press  to view or set the NO_x Correction Factors.

Averaging Time



Averaging Time
Save will restart averaging
Averaging Time (0..60)... <input type="text" value="1"/>
F1 SAVE <input type="text" value=""/>

The Averaging Time screen allows the operator to set the averaging time of the measured concentration. From Measure Settings menu press to access the Averaging Time screen.

The Averaging Time is a sliding average. As shown above, it can be set from 0 – 60 seconds.

Press to open the field to change the time. After making your change, press again to close the field. Press to save your changes and restart the averaging of the measured concentration. You will return to the Measure Settings menu.





NO/NO_x/NO₂ Mode Times



NO/NO _x /NO ₂ Mode Times	
Purge Time before Integration in Seconds...	10
Integration Time after Purge in Seconds...	10

The NO/NO_x/NO₂ Mode Times screen allows the operator to set the Purge Time and the Integration Time. From Measure Settings menu press  to access the NO/NO_x/NO₂ Mode Times screen.

The Purge and Integration times are set to allow adequate purging and integration times between the NO and NO_x cycles. Any gas remaining in the sample stream from the previous mode is purged before integration into the next mode. All NO and NO_x readings are displayed as averaged values, and the sample read times can be adjusted by the operator. See [NO/NO_x/NO₂ Mode](#) for more information.

Use the Up/Down arrows   to highlight the field you intend to change. Press  to open the field to change the time (in seconds). After making your change, press  again to close the field. Press  to exit the screen and return to the Measure Settings screen.

NO_x Correction Factors



NO _x Correction Factors	
F1 zero NO	
F2 NO _x Zero Offset	0.000
F3 Span NO	
F4 NO _x Correction	1.000
F6 Edit NO _x Factors	



← Current Settings





NO_x Correction Factors allows the operator to adjust small offsets between the NO and NO_x modes while operating in the NO/NO_x/NO₂ mode. Press **F3₃** to access the NO_x Correction Factors menu from the Measure Settings menu.





Notes:

- NO_x Correction Factors is for advanced operators only and not necessary for normal operation.
- To properly adjust for any offsets, all four steps need to be done in order from **F1₁** through **F4₄**.
- There is only one set of Offset and Correction Factors for all ranges.
- Calibrating in NO_x single mode will automatically reset the NO_x Correction Factor to the default settings of “0” and “1”.

Press **F1₁** to set the analyzer in NO mode and enter the Manual Zero Calibration screen. Introduce zero gas into the rear of the analyzer. Once the concentration stabilizes, press **F1₁** to set the Zero. Press **BACK** to return to the NO_x Correction Factors menu.

Press  to set the analyzer in NO_x mode and enter the Manual Zero Calibration screen. Introduce zero gas into the rear of the analyzer. Once the concentration stabilizes, press  to set the Zero Offset. Press  to return to the NO_x Correction Factors menu.

Press  to set the analyzer in NO mode and enter the Manual Span Calibration screen. Introduce NO span gas into the rear of the analyzer. Verify that the span concentration on the screen matches the Nitric Oxide concentration on the bottle certificate. If the concentration does not match, press  and change the concentration to match. Once the concentration stabilizes, press  to set the span. Press  to return to the NO_x Correction Factors menu.

Press  to set the analyzer in NO_x mode and enter the Manual Span Calibration screen. Introduce NO span gas into the rear of the analyzer. Set the concentration on the screen to match the Total Oxides of Nitrogen concentration from the bottle certificate. Press  and change the concentration, then press  again to close the field. The concentration value is temporarily set and will revert back to the original span concentration. Once the concentration stabilizes, press  to set the NO_x correction factor. The correction factors are now set.

NO _x Factors	
NO _x Zero Offset...	0.00
NO _x Correction...	1.00
F1 SAVE	
F2 Reset Default	

Press  to manually edit the NO_x Factors.

Output Settings

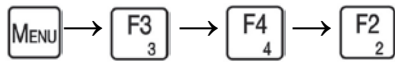

Output Settings
F1 Programmable Analogs
F2 Programmable Digitals

The Output Settings menu allows the operator to change the analyzer's Programmable Analog and Programmable Digital outputs to suit the operator's needs. The Output Settings menu is accessed by pressing  from the Setup menu.

Press  to see the Programmable Analogs menu, which allows the operator to view or change the analog Output Assignments, Output Scaling or make Output Adjustments.

Press  to see the Programmable Digitals menu, which allows the operator to view or change the Digital Output Assignments, choose Output Hold or Clear, or conduct an Output Test.

Programmable Analogs





Programmable Analogs
F1 Output Assignments
F2 Output Scaling
F3 Output Adjustments

The Programmable Analogs menu provides access to the following Setup parameters: Output Assignments, Output Scaling and Output Adjustments. The

Programmable Analogs menu is accessed by pressing  from the Output Settings menu.

Press  to view or reassign the four programmable analog output signals.

Press  to view or set the output scaling of programmable analog output signals.

Press  to set or adjust the analog outputs. The operator can set the output to either current or voltage, and calibrate the outputs to exactly match the results obtained on a PLC or other remote data-recording device.



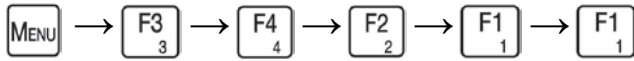



Output Assignments



Output Assignments	
Output	Signal
AO-1	AIrEPC
AO-2	RealTime
AO-3	RealTime
AO-4	RealTime
F1 SAVE	

The Output Assignments screen allows the operator to view or change the signals assigned to the programmable analog outputs. From the Programmable Analogs menu

press  to access the Output Assignments screen.

Use the Up/Down arrows   to highlight the field you intend to change. Press  to open the field and use the Up/Down arrows   to change it to the desired signal. Press  again to close the field. Press  to save your changes.

NOTES:

1. Analog Output 1 (for example) is listed as AO-1 in the Output column.
2. For information on analog output connections see [Analog and Digital Interface](#).

The following output signals can be programmed by the operator from the Output Assignments screen:

RealTime: In either NO or NO_x mode the concentration's output will be a live reading.

NO: In NO mode the concentration's output will be a live reading. In NO/NO_x/NO₂ mode the output will be a read and hold.

NO₂: The calculated concentration's output will be updated after each complete cycle in NO/NO_x/NO₂ mode.

NO_x: In NO_x mode the output concentration will be a live reading. In NO/NO_x/NO₂ mode the output will be a read and hold.

SamplePres: Sample pressure (psig).

AirPres: Air pressure (psig).

CaseTemp: Analyzer's internal temperature (°C).

OvenTemp: Oven temperature (°C). (Heated version.)

ConvTemp: Converter temperature (°C).

PumpTemp: Internal pump temperature (°C). (Heated version.)

DiodeTemp: Photodiode temperature (°C).

CellTemp: Sample cell temperature (°C).

DryerTemp: Gas temperature of the rear-mounted chiller (°C). (Versions with chillers.)

Sample EPC: % of voltage supplied to the Sample electronic proportioning control valve.



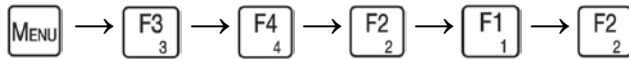

AirEPC: % of voltage supplied to the Air electronic proportioning control valve.

Output Scaling



Output Scaling		
Default scaling use 0.00		
Output	Lower	Upper
AO-1	0.00	0.00
AO-2	0.00	0.00
AO-3	0.00	0.00
AO-4	0.00	0.00
F1 SAVE		

The Output Scaling screen allows the operator to scale the analyzer's Analog Outputs to a specific value for each of the four output signals. This is generally used for scaling of temperatures or pressures, but it can also be used to set an output for a specific concentration. From the Programmable Analogs menu press  to access the Output Scaling screen.

Use the Up/Down arrows   to highlight the field you intend to change. Press  to open the field to change the value. After making your change, press  again to close the field. Press  to save your changes and return to the Programmable Analogs menu.

NOTES:

- Analog Output 1 is indicated as AO-1 in the Output column.
- 0 to 10 VDC output is used for the following three examples:

EXAMPLES:

1. When the analog [Output Assignment](#) is set for Cell Temperature and the lower setting is set to 0.00 and the upper setting is set to 100.00, 66°C will = 6.6 VDC.
2. When the analog [Output Assignments](#) are set for concentrations and the default upper and lower settings are 0.00 and 0.00, the default settings allow the output voltage to follow the range limits.

Example: If Range 1 is set to 10 ppm and Range 2 is 100 ppm, in Range 1 10 ppm will = 10 VDC and in Range 2 100 ppm will = 10 VDC.

3. When the analog [Output Assignment](#) is set for concentrations and the lower setting is set to 0.00 and the upper setting is set to 10.00, the output will no longer follow the range limit and will be locked to 10 ppm.

Example: If Range 1 is set to 10 ppm and Range 2 is 100 ppm, in Range 1 10 ppm will = 10 VDC and in Range 2 10 ppm will = 10 VDC.

Output Adjustments

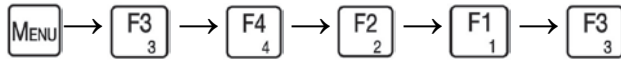











Output Adjustments			
Output Type...			mA
Output	%FS	Offset	Gain
AO-1	Meas	0.8303	0.8297
AO-2	Meas	0.8324	0.8293
AO-3	Meas	0.8253	0.8225
AO-4	Meas	0.8275	0.8235
F1 SAVE			







The Output Adjustments screen allows the operator to set the output to either mA or voltage and calibrate the outputs to exactly match the results obtained on a PLC or other remote data-recording device. Using the Output Adjustments screen, the operator can force the analog outputs to 0%, 50% or 100% of full scale and back to Measure. For information on analog output connections see [Analog and Digital Interface](#).

From the Programmable Analogs menu press  to access the Output Adjustments screen.

- **Output Type** can be set for mA or 1, 5 or 10 VDC.
- **Output AO-1** refers to analog output 1.
- **% FS** is used to toggle between Measurement, 0%, 50% and 100% Full scale.
- **Offset** (zero) is used to adjust the output at 0%.
- **Gain** (span) is used to adjust the output at 100%.

To select the **Output Type** press  to open the highlighted field. Use the Up/Down arrows   to make your selection. Press  again to close the field.

Once the output type has been selected, use the Left/Right arrows   to move the highlight into the % FS column of the output to be checked. Press  until the % FS value reads 0.000. To adjust the zero (Offset), use the Left/Right arrows   to highlight the Offset column and press  to open the field. Make a small adjustment to the Offset value and then press  to close the field. Repeat this procedure as necessary.

To adjust the output to Full scale, use the Left/Right arrows   to move the highlight into the % FS column and press  until the % FS column value reads 100.0. Then use the Left/Right arrows   to highlight the Gain column. Press  to open the field. Make a small adjustment and press  again to close the field and check the output. Repeat this procedure as necessary for other outputs.

When you are finished making all your changes press  to save them. You will return to the Programmable Analogs menu.

NOTE: Failure to save your adjustments will result in the numbers reverting back to the defaults after power is turned off and back on.

The following table includes typical Programmable Analog Output values:

OUTPUT	OFFSET	GAIN
0-20 mA	0.000	0.828
4-20 mA	1.658	0.662
0-1 V	0.828	0.828
0-5 V	0.828	0.828
0-10 V	0.828	0.828

Output Assignments

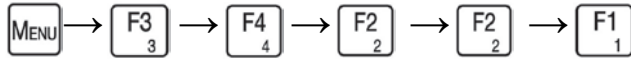





Output Assignments			
15 programmable outputs			
1	Sampler	2	Off
2	Off	4	Off
3	Off	6	Off
4	Off	8	Off
5	Off	10	Off
6	Off	12	Off
7	Off	14	Off
8	Off		
9	Off		
10	Off		
11	Off		
12	Off		
13	Off		
14	Off		
15	Off		
F1 SAVE			

The Output Assignments screen allows the operator to assign any of the 15 programmable digital outputs to a specific alarm or status. From the Programmable

Digitals menu press  to access the Output Assignments screen.

Use the left and right arrow buttons   to highlight the field you intend to change.

Press  to open the field and use the up or down arrow button   to change

the signal. Press  again to close the field. Press  to save your changes.

NOTES:

1. For information on digital output connections see [Analog and Digital Interface](#).
2. Alarms go open when present and statuses go closed when active.
3. See the following tables for a list of Alarms and Statuses:

Programmable Digital Output List

Alarms

- **SampP** – Sample Pressure
- **AirP** – Air Pressure
- **OvenT** – Oven Temperature
- **ConvT** – Converter Temperature
- **PumpT** – Pump Temperature
- **DiodT** – Diode Temperature
- **CellT** – Cell Temperature
- **DryT** – Dryer Temperature
- **O2T** – Oxygen Temperature
- **SEPC** – Sample EPC Voltage
- **AEPC** – Air EPC Voltage
- **ROvr** – Over Range
- **AOvr** – ADC Over Range
- **AUnd** – ADC Under Range
- **R1NC** – Range 1 not calibrated
- **R2NC** – Range 2 not calibrated
- **R3NC** – Range 3 not calibrated
- **R4NC** – Range 4 not calibrated
- **O2NC** – O₂ not calibrated
- **Conc1** – Concentration Alarm 1
- **Conc2** – Concentration Alarm 2
- **O2ADC** – O₂ ADC Alarm
- **O2C1** – O₂ Concentration Alarm 1
- **O2C2** – O₂ Concentration Alarm 2
- **GenAlarm** – General Alarm
- **Cal Alarm** – Calibration Alarm

Statuses

- **Zero** – In Zero Mode
- **Span** – In Span Mode
- **Sample** – In Sample Mode
- **InNO** – In NO Mode
- **InNOX** – In NO_x Mode
- **InWet** – In Wet Mode
- **Dual** – In NO/NO_x/NO₂ Mode
- **InRem** – In Remote
- **AutoR** – In Auto Range
- **R1** – In Range 1
- **R2** – In Range 2
- **R3** – In Range 3
- **R4** – In Range 4
- **InCal** – In Calibration Mode
- **ZeroO2** – In Zero O₂ Mode
- **SpanO2** – In Span O₂ Mode

General Alarms

- **Sample Pressure**
 - **Air Pressure**
 - **Oven Temperature**
 - **Converter Temperature**
 - **Pump Temperature**
 - **Diode Temperature**
 - **Cell Temperature**
 - **Dryer Temperature**
 - **O2 Temperature**
 - **Sample EPC Voltage**
 - **Air EPC Coil Voltage**
 - **ADC Over Range**
 - **ADC Under Range**
 - **O2 ADC Error**
-

Output Hold/Clear

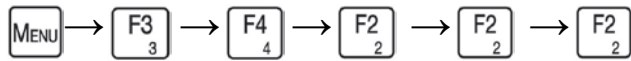

Output Hold/Clear	Clear
F1 Hold Outputs	
F2 Clear Outputs	

The Output Hold/Clear menu allows the operator to choose whether to hold or clear a triggered alarm when the alarm is no longer present. The current status is shown in the upper-right corner of the Output Hold/Clear menu. The Output Hold/Clear menu is accessed by pressing  from the Programmable Digitals menu.

Press  to hold programmed alarm outputs until they are manually cleared.

Press  to set the outputs to automatically clear when alarms are no longer present.

NOTES:

- To manually clear held alarms, press  from this menu. An output alarm cannot be cleared until the alarm is back within its limits.
- Once the outputs are cleared, the outputs will not hold on alarms until they are set back to Hold.

Output Test

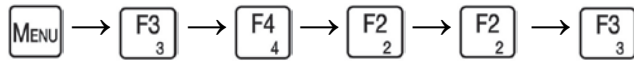





Output Test			
Must reboot after testing			
11349-1050	Open	2	Open
11349-1050	Open	4	Open
11349-1050	Open	6	Open
11349-1050	Open	8	Open
11349-1050	Open	10	Open
11349-1050	Open	12	Open
11349-1050	Open	14	Open
F1 ALL			



The Output Test Screen allows the operator to test the Programmable Digital Outputs to make sure they are functioning properly. The Output Test Screen is accessed by pressing

from the Programmable Digitals menu. The Output Test Warning screen first appears, asking if you wish to continue the output test. If you proceed with the test, you **must** reboot the analyzer to exit the output test.

Output Test	
* * WARNING * *	
Going into the Output Test will require you to REBOOT the analyzer after you are done testing the outputs	
Would you like to continue?	
F1	Yes
F2	No

To exit the Output Test screen and proceed with normal operation press . To continue to the Output Test screen press . For information on output connections see [Analog and Digital Interface](#).

To test outputs one at a time, use the Up/Down arrows   to highlight the desired output, then press  to change the state of the output (open or closed). Press  again to change the state back.

To test all the outputs at once, press  to change the state of all the outputs (they are all Open in the example). Press  again to change all the output states back.

Upon completion of the test, you will be required to reboot the analyzer to resume operation.

TCP/IP Parameters

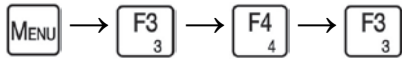

TCP/IP Parameters	
Must REBOOT after saving	
HWaddress	00.E0.4B.1A.FA.B0
IP-address	192.168.002.032
Netmask	255.255.255.000
Port	7700
Gateway	000.000.000.000
WinIfPort	2000
F1 SAVE	



The TCP/IP Parameters screen is used for setting up the parameters for communication between an analyzer and computer. The TCP/IP Parameters screen is accessed by pressing



 from the Setup menu.

TCP (Transmission Control Protocol) is a standard protocol for sending information between devices connected to a computer network. It includes a format of packets, also called datagrams.

IP (Internet Protocol) specifies the addressing scheme. Most networks combine IP with TCP, establishing a virtual connection between destination and source.

The IP-address, Netmask and Gateway may be defined by the user. The Port and WinIfPort are assigned 7700 and 2000 by CAI and should not be changed unless required for a certain location.

Use the Up/Down arrows   to move the highlight to the setting you wish to change.

Press  to open the field to change the value. After making your change, press  again to

close the field. Press  to save your changes and return to the Setup menu. The new settings will take effect after the analyzer is rebooted.

Data Logging Time

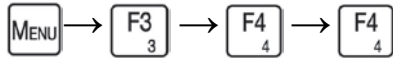



Data Logging Time	
There are 16 user timed data log files.	
Each holds 1800 data lines.	
The minimum time is 1 second.	
At 1 Sec. each file holds 30 minutes of snapshot data.	
Logging Interval 0=Off...	0
F1 SAVE	

Data logging allows the analyzer to store internal variables to support CAI

troubleshooting. When troubleshooting with CAI Technical Support, the operator may be asked to turn this feature on. These files can only be accessed by CAI. To access the Data Logging

screen, press  from the Setup menu.

To turn Data Logging on, press  to open the field, and change the logging interval from 0 to the desired time (in seconds). After making your change, press  again to close the field.

Press  to save your change and return to the Setup menu.

To turn Data Logging off, change the interval to 0 and press  to save.

Auto Start Settings

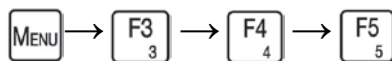

Auto Start Settings	
Auto Startup	On
Wait for [min]	00
Calibrations	0000
Startrange	2
Access Level	Manual
Remote/Manual	NOx
NO/NO _x -Mode	
F1 SAVE	

The Auto Start Settings screen allows the operator to set parameters that will take effect upon power up of the analyzer. The Auto Start Settings screen is accessed by pressing  from the Setup menu.

If the Auto Startup function is turned off, the analyzer will boot up with the same settings the analyzer was last in. The operator can set the following parameters:

Auto Startup – Turn the Auto Startup function on or off.

Wait for (min) – Allow for the time it takes for the analyzer to warm up before calibration.





Calibrations – Set the number of calibrations the analyzer will perform.

Start Range – Specify the range to set upon Power Up.

Access Level – Select the Operator Security Level.

Remote/Manual – Set whether the analyzer starts up in Remote or Manual mode.

NO/NO_x Mode – Select the mode the analyzer starts up in; NO, NO_x or NO/NO_x/NO₂ mode.



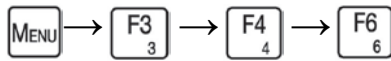

To change a setting, use the Up/Down arrows   to move the highlight to the setting you wish to change. Press  to open the field to change the value. After making your change, press  again to close the field. Press  to save your changes and return to the Setup menu.

Clock Settings



Clock	
Current System Time Sat Jun 07 10:51:31 2013	
Change Time and Date	
Weekday	Tue
Date (mm.dd.yy)	Jun 07 2013
Time (HH:MM:SS)	10:49:08
F1 SAVE	

The Clock Settings screen allows the operator to set the analyzer's internal clock. The internal clock is used for auto calibrations and data time stamping. The Clock Settings screen is accessed by pressing  from the Setup menu.

To change a setting, use the Up/Down arrows   to move the highlight to the setting you wish to change. Press  to open the field to change the value. After making your change, press  again to close the field. Press  to save your changes and return to the Setup menu.

Alarms Menu





Alarms
F1 Current Alarms
F2 Alarm Log
F3 Alarm Limits
F4 Alarm Display On/Off...On

The Alarms menu allows the operator to view **Current Alarms**, the **Alarm Log** and settable **Alarm Limits**. From the Menus screen press  to access the Alarms menu.

Press  to access the Current Alarms screen and view the alarms that are currently active.

Press  to access the Alarm Log. The operator can view a log of the last 40 alarms.

Press  to access the Alarm Limits menu. The operator can view or change the existing alarm limits.

Press  to turn On or Off the display of the active alarms that scroll across the bottom of the Measure screen. The current setting is shown on the Alarms menu on the right side of the screen after the ellipsis (...). **Example: Alarm Display. . . On.**

Current Alarms

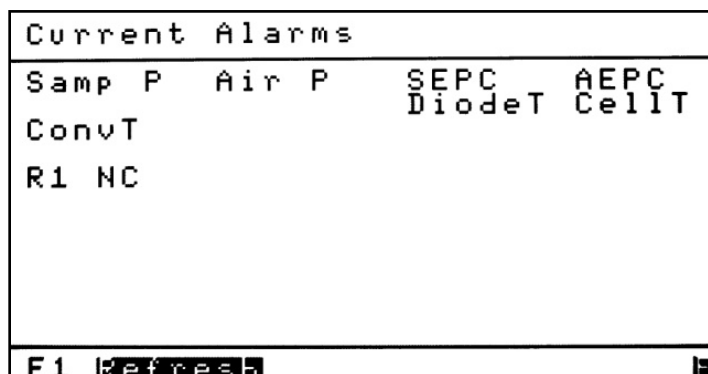
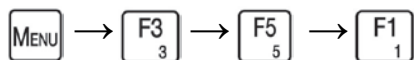

The Current Alarms screen allows the operator to view the analyzer's current alarms at the time this screen was accessed. To access the Current Alarms screen press  from the Alarms menu.

Press  to refresh this screen. (This screen does not auto refresh.)

Current Alarm Abbreviations

SampP – Sample Pressure

AirP – Air Pressure

OvenT – Oven Temperature

ConvT – NO_x Converter Temperature

PumpT – Pump Temperature

DiodT – Diode Temperature

CellT – Cell Temperature

DryT – Dryer Temperature

O2T – Oxygen Det Temperature

SEPC – Sample EPC Voltage

AEPC – Air EPC Voltage

ROvr – Over Range

AOvr – ADC Over Range

AUnd – ADC Under Range

R1NC – Range 1 not calibrated

R2NC – Range 2 not calibrated

R3NC – Range 3 not calibrated

R4NC – Range 4 not calibrated

O2NC – O₂ not calibrated

Conc1 – Concentration Alarm 1

Conc2 – Concentration Alarm 2

O2ADC – O₂ ADC Alarm

O2C1 – O₂ Concentration Alarm 1

O2C2 – O₂ Concentration Alarm 1

Alarm Abbreviations and Descriptions

SampP – Sample Pressure

AirP – Air Pressure

OvenT – Oven Temperature

ConvT – O₂ Converter Temperature

PumpT – Pump Temperature

DiodT – Diode Temperature

CellT – Cell Temperature

DryT – Dryer Temperature

O₂T – Oxygen Temperature

SEPC – Sample EPC Voltage

AEPC – Air EPC Voltage

ROvr – Over Range

AOvr – ADC Over Range

AUnd – ADC Under Range

R1NC – Range 1 not calibrated

R2NC – Range 2 not calibrated

R3NC – Range 3 not calibrated

R4NC – Range 4 not calibrated

O₂NC – O₂ not calibrated

Conc1 – Concentration Alarm 1

Conc2 – Concentration Alarm 2

O₂ADC – O₂ ADC Alarm

O₂Conc1 – O₂ Concentration Alarm 1

O₂Conc2 – O₂ Concentration Alarm 2

Alarm Limits

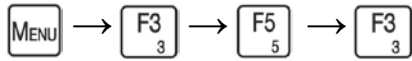



Alarm Limits
F1 Temperatures
F2 Pressures
F3 EPC
F4 Concentrations

The Alarm Limits menu allows the operator to view or change the current upper and lower alarm tolerances. When the signals go above or lower than the assigned limit an alarm is

triggered. To access the Alarm Limits menu, press  from the Alarms menu.

Press  to access the Temperatures screen. It allows the operator to set the upper and lower temperature alarm limits.

Press  to access the Pressures screen. It allows operator to set the upper and lower alarm limits for sample and air pressure.

Press  to access the EPC % screen. It allows the operator to view or change the existing alarm limits of EPC voltage being supplied to the EPC valve.







Press  to access the Concentration Alarms screen. It allows the operator to view or change the upper and lower gas concentration alarm limits.

Temperatures



Temperature [°C]		
Alarms	LoLimit	HiLimit
Cell	65.00	69.00
Diode	-5.50	-4.50
Conv	204.00	210.00
Oven	84.00	88.00
Pump	84.00	102.00
Dryer	-2.00	7.00







F1 SAVE

From the Alarm Limits menu, press  to access the Temperatures screen. Use the left or right arrow   to highlight the alarm limit you wish to change. Press  to open the field to change the value. After making a change, press  again to close the field. Press  to save your changes.

Pressures





Pressure [PSIG]		
Alarms	LoLimit	HiLimit
Sample	3.80	3.90
Air	14.00	16.00
F1 SAVE		

From the Alarm Limits menu, press  to access the Pressures screen. Use the left or right arrow   to highlight the alarm limit you intend to change. Press  to open the field to change the value. After making a change, press  again to close the field. Press  to save your changes.

EPC Voltages



EPC [%]		
Alarms	LoLimit	HiLimit
Sample	10	85
Air	10	85
F1 SAVE		

From the Alarm Limits menu, press **F3₃** to access the EPC Voltage Alarm Limits screen. Use the left or right arrow   to highlight the alarm limit you intend to change. Press **ENTER** to open the field to change the value. After making a change, press **ENTER** again to close the field. Press **F1₁** to save your changes.









Concentrations



Concentration Alarms [ppm]			
Alarms	Limit	Type	
Conc 1	3000.00	Hi	Lo/Hi
Conc 2	3000.00	Hi	Lo/Hi
F1 SAVE			

Concentration alarms can be set to trigger an alarm below or above a specified

concentration. From the Alarm Limits menu, press  to access the Concentration Alarm Limits screen.

Use the left or right arrow   to highlight the concentration alarm limit you intend to change. Press  to open the field to change the value. After making a change, press  again to close the field. After the concentration limit is set, specify whether the alarm will be set for a High or Low alarm. Use the left or right arrow   to highlight the alarm type (High or Low). Press  to toggle between Hi or Lo. Press  to save your changes.

To set the alarm to a digital output, see Programmable Digital [Output Assignments](#).

Alarm Display On/Off

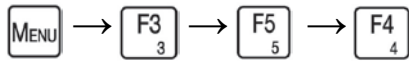



Alarm Display On/Off	On
F1 Turn Alarm Display On	
F2 Turn Alarm Display Off	

The Alarm Display On/Off menu allows the operator to turn On or Off the Alarm Display that scrolls across the bottom of the Measure screen. Programmed digital output alarms will not be affected by this setting; only the display will be turned off. The scrolling alarms will be replaced with the CAI phone number when an alarm is active. If there are no alarms, only the date and time will be displayed.

Press  from the Alarms Menu to access this menu. The current setting is shown in the upper-right corner of the Alarm Display menu. (In the above example, On.)

From the Alarm Display On/Off menu:

Press  to turn the Alarm Display On.

Press  to turn the Alarm Display Off.

Service Menu



Service
F1 Linear Coefficients
F2 Factory Service

The Service Menu is for advanced operators and CAI Service. The Service menu provides access to operator-level linear coefficients and CAI factory service. From the Menus screen press

 to access the Service menu.

Press  to view or change operator-level linear coefficients.

Press  to access Factory Service menus. **For CAI use only.**

Linear Coefficients

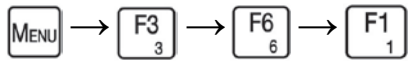

Linear Coefficients
F1 Range 1
F2 Range 2
F3 Range 3
F4 Range 4

The Linear Coefficients function allows the operator to optimize linearity by inputting up to five coefficients for each range to generate up to a fourth-order curve. From the Service









menu press  to access the Linear Coefficients screen.

NOTES:

- Changing linear coefficients can compromise the analyzer's accuracy and ability to function properly.
- To reset Factory Coefficients see Reset Factory Settings.

Select the corresponding function key for the range you wish to edit. In the example,  was pressed to allow the Range 1 Linear Coefficient to be changed.

Range 1	
a0	0.000000e+00
a1	1.000000e+00
a2	0.000000e+00
a3	0.000000e+00
a4	0.000000e+00
F1 SAVE	

Use the Up/Down arrows   to highlight the coefficient you intend to change. Press  to open the field, use the left and right arrow buttons   to position the cursor, and use the Up/Down arrows   or number keys to make your change. Press  again to close the field. Press  to save your changes.

Service Menu

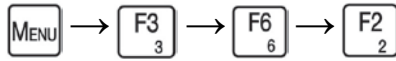

Unauthorized Access
Current Level 2
Current level does not allow You to change Settings.
F1 to Change Level

The Factory Service menus can only be accessed by California Analytical Instruments. The best way to contact CAI with a support question is to fill out our brief Technical Support Form at http://www.gasanalyzers.com/technical_support/new.

Security



Security
F1 Operator Levels
F2 Change Password
F3 Reset Password

The Security menu allows the operator to change the access to Standard or Setup Function menus and change or reset the Setup Function password. From the Menus screen press  to access the Security menu.

Press  to set the operator's access level. The Operator Levels menu allows the operator to choose either Standard Functions or advanced Setup Functions.

Press  to change the password that allows the operator access to the Setup Functions menu.

Press  to enter the master password that resets the Setup Functions password to the original factory setting.

Operator Levels

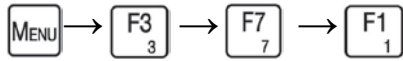

Operator Levels
F1 Standard Functions
F2 Setup Functions
F3 Factory Functions

The 700 HCLD has three operator access levels which allow the operator to access different analyzer functions. From the Security Menu screen press  to access the Operator Levels screen. See [Menu Flow Chart](#) for security levels and functions.

Press  to set the operator level to Standard Functions for basic operation and calibration. No password is required.

Press  to set the operator level to Setup Functions for advanced operators. This allows the operator access to all standard functions, setup functions and parameters. Setup Functions requires the operator to enter the password “222.” The analyzer will remain in this level until the operator changes it.

 Factory Functions is for CAI use only.

Change Password

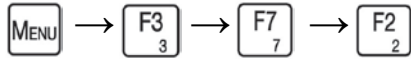

Change Password	
Standard Functions	111
Setup Functions	222
F1 SAVE	

The Change Password screen allows the operator to change the Setup Functions password from the factory-preset 222 to a new password. From the Security menu screen press  to access the Operator Levels screen.

To change the password, press  to open the field.



Enter a new 3-digit password. Press  again to close the field.

Press  to save the new password.

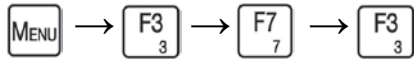
Reset Password



The Reset Password screen allows the operator to reset the Setup Password to the original factory password (222). From the Security menu screen press  to access the Reset Password screen.

To return the password to the original factory password, you must enter **WIZARD** in the field. Press  to open the field and bring up a cursor. Use the Up arrow  to scroll to **W**. Use the Right arrow  to move to the next letter and scroll to **I** and so on.

Repeat this procedure until you have finished entering **WIZARD**. Press  and the password for the Setup functions will be reset to **222**.

Communication and Interface

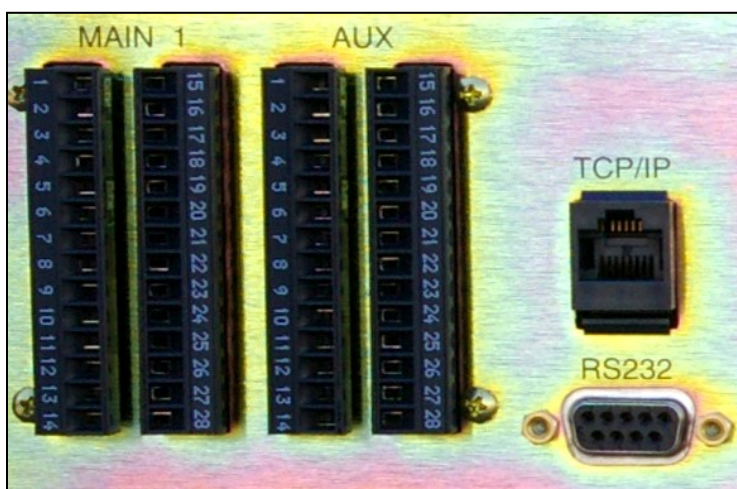

Analog and Digital Interface

The Main and Auxiliary connectors provide the analog outputs for concentrations and other variable signals. Digital Status outputs, Control inputs and Calibration drive signals are also provided. There are four analog outputs, whose type (mA or specific voltage range) and signal assignments are assignable from the Setup menu. See the following tables for pin numbers and functions.

Serial Interface

The 9-pin Serial Interface connector provides RS-232 remote control and data access to the analyzer via the AK protocol.

Network Port

The TCP/IP port allows the analyzer to be accessed via a network connection. The analyzer requires a static IP address that is settable from the Setup menu. Either AK or Modbus protocol can be used to access the analyzer remotely.

Analog and Digital Interface

Hardware Capabilities of Main and Aux Connectors

Analog Output

The operator can choose one of the following output types:

- As voltage outputs – 0 to 1V, 5V or 10V
- As current outputs – 0 to 20 mA or 4 to 20 mA

When set as current outputs, the maximum drive voltage provided by the analyzer is slightly more than 20 Volts, requiring that the maximum loop resistance less than 1K Ohms. Voltage load should be 2K ohms or more. The Isolated Analog Ground (Main, Pin 1) is the only pin that should be used as the return line for the four analog outputs.

See [Programmable Analog Output Adjustments](#).

Digital Output

There are two types of digital outputs:

- Static Digital Outputs – Permanently assigned to often-needed functions. These are opto-isolated, solid-state Normally Open (NO) relays that connect to the Digital Ground (Main, Pin 6 and Pin 28).
- Programmable Digital Outputs – Have dedicated returns for each block of four outputs. Refer to the Aux Connector Pinout chart below to determine which pin is used for the corresponding Programmable Digital Output. When the output is programmed as a status it will close to indicate the function. When programmed as an alarm the output will open to indicate an alarm.

All opto-isolated relays are rated for 48VDC, 0.5 Amp maximum. The user is required to limit the drive current supplied to each input. All inputs are DC only and will not operate on AC current.



CAUTION: Do not connect these pins directly to both sides of a voltage power supply as unrestricted current will damage the relay.

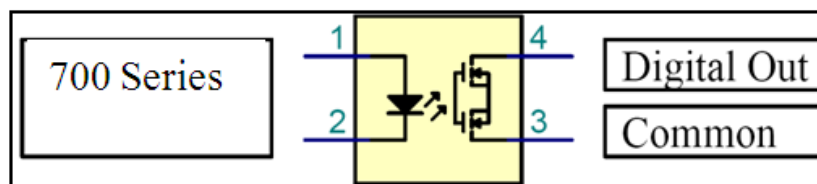

Example of digital output driver.

Digital Input

The analyzer's Digital Inputs are internally pulled up to 5VDC and are operated by user equipment connecting an input to the Digital Ground (Main, Pin 6). Note that some lines require only momentary operation, and some selection lines are intended to be held continuously.

DRV

The calibration gas valve drivers are application-specific and intended for solenoid valve drive. 24VDC valves with a maximum wattage of 12 Watts should be used. The 24VDC used to operate the valves should be connected to the coils, and the analyzer inputs when operating will pull the valve current to Digital Ground.

24VDC

The 24VDC output is intended for use with properly rated solenoid valves. **CAUTION:** Use of this output for other purposes can damage the analyzer.

Analog Input

The Analog Input is reserved for factory signals. **CAUTION:** Do not connect to this input or damage may occur.

28-Pin Main (BPM) Connector Assignments

Pin #	Signal	Signal Type	Operation
1	Isolated Analog Ground	Analog Output	Isolated Analog Ground
2	User-Defined AO-1	Analog Output	1V, 5V, 10VDC or mA
3	User-Defined AO-2	Analog Output	1V, 5V, 10VDC or mA
4	User-Defined AO-3	Analog Output	1V, 5V, 10VDC or mA
5	User-Defined AO-4	Analog Output	1V, 5V, 10VDC or mA
6	Digital Ground	Digital Ground	Digital Ground
7	Sense Auto Range	Digital Output	NO Relay to Digital Ground
8	Sense Range 1	Digital Output	NO Relay to Digital Ground
9	Sense Range 2	Digital Output	NO Relay to Digital Ground
10	Sense Range 3	Digital Output	NO Relay to Digital Ground
11	Sense Range 4	Digital Output	NO Relay to Digital Ground
12	Set Auto Range	Digital Input	Hold to Ground in Remote
13	Control Range 1	Digital Input	Hold to Ground in Remote
14	Control Range 2	Digital Input	Hold to Ground in Remote
15	Control Range 3	Digital Input	Hold to Ground in Remote
16	Control Range 4	Digital Input	Hold to Ground in Remote
17	Auto Cal	Digital Input	Momentary Hold to Ground
18	Calibrate	Digital Input	Momentary Hold to Ground
19	Zero	Digital Input	Momentary Hold to Ground
20	Span	Digital Input	Momentary Hold to Ground
21	Sample	Digital Input	Momentary Hold to Ground
22	Zero Gas Flow	Digital Output	DRV
23	Span Gas Flow	Digital Output	DRV
24	Sample Gas Flow	Digital Output	DRV
25	Local/Remote	Digital Output	NO Relay to Digital Ground
26	Read Cal Mode	Digital Output	NO Relay to Digital Ground
27	24 VDC	24 VDC	24 VDC
28	Digital Ground	Digital Ground	Digital Ground

28-Pin Auxiliary (BPA) Connector Assignments

Pin #	Signal	Signal Type	Operation
1	Analog Ground	Analog Input	Analog Ground
2	Reserved	Analog Input	Reserved
3	Reserved	Analog Input	Reserved
4	Reserved	Analog Input	Reserved
5	Relay RTN 1	Digital Output	RTN Relays 1 - 4
6	Relay RTN 2	Digital Output	RTN Relays 5 - 8
7	Relay RTN 3	Digital Output	RTN Relays 9 - 12
8	Relay RTN 4	Digital Output	RTN Relays 13 - 15
9	User-Defined NO Relay 1	Digital Output	Uses Relay RTN 1
10	User-Defined NO Relay 2	Digital Output	Uses Relay RTN 1
11	User-Defined NO Relay 3	Digital Output	Uses Relay RTN 1
12	User-Defined NO Relay 4	Digital Output	Uses Relay RTN 1
13	User-Defined NO Relay 5	Digital Output	Uses Relay RTN 2
14	User-Defined NO Relay 6	Digital Output	Uses Relay RTN 2
15	User-Defined NO Relay 7	Digital Output	Uses Relay RTN 2
16	User-Defined NO Relay 8	Digital Output	Uses Relay RTN 2
17	User-Defined NO Relay 9	Digital Output	Uses Relay RTN 3
18	User-Defined NO Relay 10	Digital Output	Uses Relay RTN 3
19	User-Defined NO Relay 11	Digital Output	Uses Relay RTN 3
20	User-Defined NO Relay 12	Digital Output	Uses Relay RTN 3
21	User-Defined NO Relay 13	Digital Output	Uses Relay RTN 4
22	Reserved	Reserved	Reserved
23	Set Wet Mode / O ₂ Cal	Digital Input	Hold to Ground in Remote
24	NO/NO _x /NO ₂ Mode	Digital Input	Hold to Ground in Remote
25	Set NO Mode	Digital Input	Hold to Ground in Remote
26	Set Remote	Digital Input	Hold to Ground
27	User-Defined NO Relay 14	Digital Output	Uses Relay RTN 4
28	User-Defined NO Relay 15	Digital Output	Uses Relay RTN 4

Serial Interface

The serial interface enables remote control of the analyzer by a master computer. It is implemented as an RS232 V24 interface and meets all requirements of the AK protocol. A 9-pin male connector at the back of the unit is used to connect a master computer with the following pin assignment:

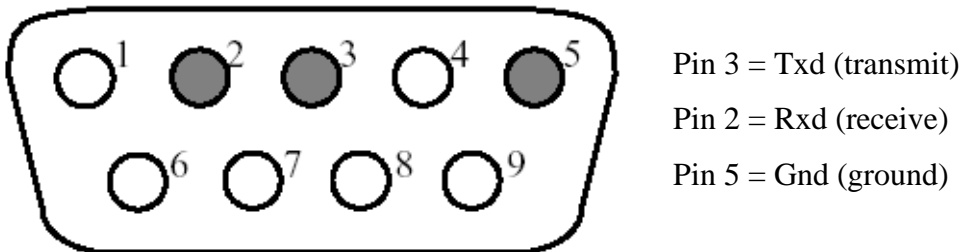

Figure 0-1 Serial Interface

Interface Specifications

Baud Rate:	9600, 4800, 2400, 1200, 600, 300 baud
Data Bits:	7 or 8
Stop Bit:	1 or 2
Don't Care:	1 byte, adjustable (e.g. 32)
Parity:	Even, odd, none
XON/XOFF:	Active or not active
Hand Shake:	No

Ethernet RJ47

If connecting directly to a computer (without using a hub or switch), a crossover cable is required.

AK Protocol

Data Description

Each command begins with STX (Start of Text) in the first byte. The “don’t care” byte can be any ASCII character. Generally, a blank space or an underscore (_) is used to increase readability. The four function bytes represent the AK command. A blank space comes next, followed by K and the channel number. The analyzer is a single-channel device, and because of that, the channel number is usually 0. For delimiting the command parameters from the channel number, another blank follows. This may be followed by command parameters with variable lengths. Every command ends with the ETX (End of Text) character. The Error Status byte does not indicate the real number of errors. For Error Status, use the ASTF command.

Example: Using Windows® HyperTerminal for Serial RS232 Communications with CAI 700 Series Analyzers requires:

1. HyperTerminal Software
2. Windows PC/Laptop
3. Null Modem Cable

Setup Procedure: run HyperTerminal and configure as shown:

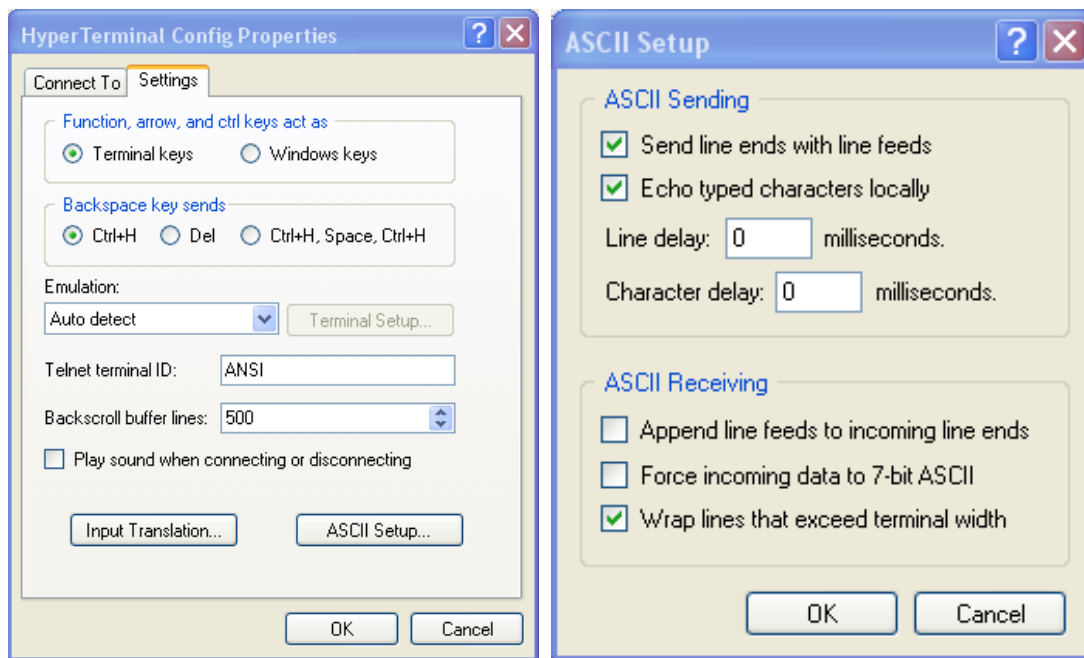

Other similar simple terminal programs should allow similar settings.

When both HyperTerminal and the analyzer are running while connected by the null modem cable, the analyzer will present a menu if sent a non-AK command. This menu can be ignored and AK commands will be acted on by the analyzer. The picture below shows a sequence with the AKON 0 command being sent to the analyzer.

Sending the analyzer characters not framed as AK commands should be prevented as the menu could recognize these characters and cause unplanned changes in configuration.

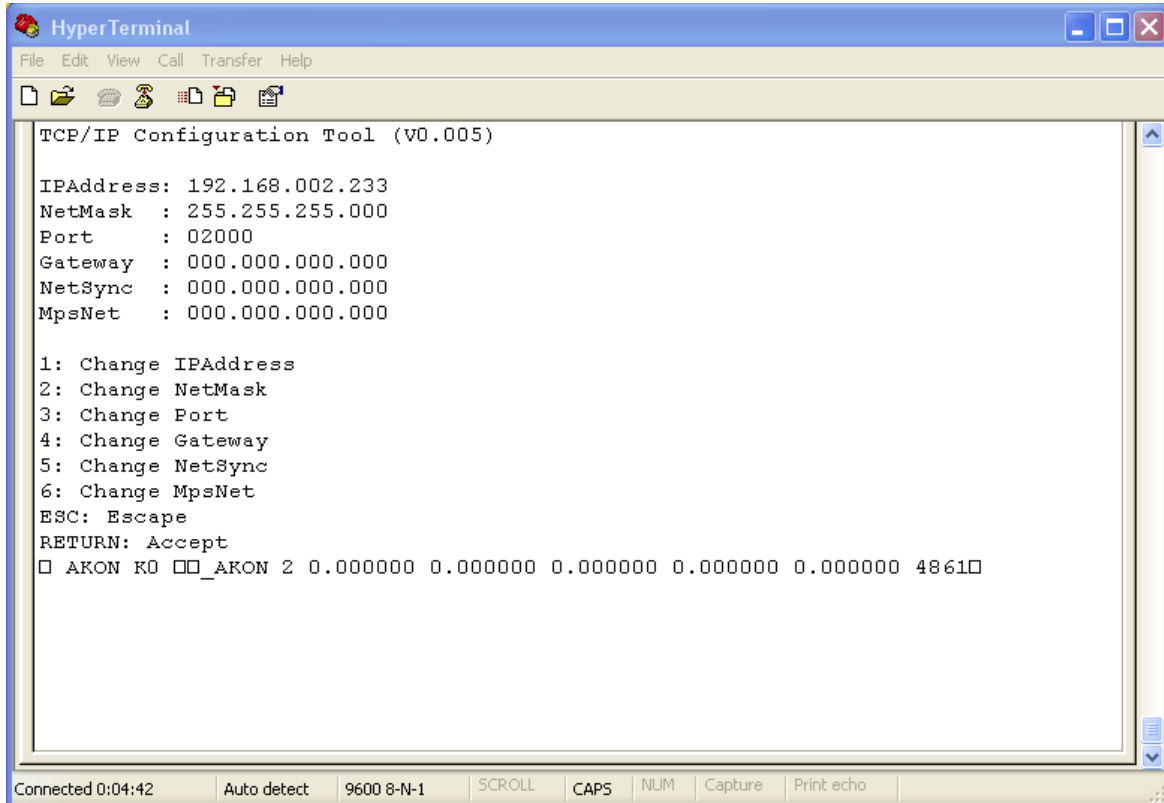

```

HyperTerminal
File Edit View Call Transfer Help
TCP/IP Configuration Tool (V0.005)
IPAddress: 192.168.002.233
NetMask : 255.255.255.000
Port : 02000
Gateway : 000.000.000.000
NetSync : 000.000.000.000
MpsNet : 000.000.000.000

1: Change IPAddress
2: Change NetMask
3: Change Port
4: Change Gateway
5: Change NetSync
6: Change MpsNet
ESC: Escape
RETURN: Accept
AKON K0 00_ AKON 2 0.000000 0.000000 0.000000 0.000000 0.000000 4861
Connected 0:04:42 Auto detect 9600 8-N-1 SCROLL CAPS NUM Capture Print echo

```

The AK command was typed into HyperTerminal using the following keystrokes:

Hit: Ctrl B (at the same time). This will start the text.

Hit: Ctrl Spacebar (at the same time).

Type: AKON (Function).

Hit: Spacebar.

Type: K0 (Channel #).

Hit: Spacebar.

Hit: Ctrl C (at the same time). This will end the text.

The analyzer will reply with numbers. If you receive ????, try the sequence again.

Instruction Command

Byte	Character	Explanation
1 st Byte	STX	ASCII Code 02
2 nd Byte	Don't Care	Any ASCII code
3 rd Byte	Function Code 1	AK instruction, e.g. ASTF
4 th Byte	Function Code 2	AK instruction, e.g. ASTF
5 th Byte	Function Code 3	AK instruction, e.g. ASTF
6 th Byte	Function Code 4	AK instruction, e.g. ASTF
7 th Byte	Blank	
8 th Byte	K	
9 th Byte	0	
10 th Byte	Blank	
	D	AK instruction parameters; lengths variable
	A	AK instruction parameters; lengths variable
	T	AK instruction parameters; lengths variable
	A	AK instruction parameters; lengths variable
nth Byte	ETX	ASCII Code 03

Example:

<STX>	02H Example: ASTZ K0
Don't Care	Any byte (default 20H)
Function Code	Code 4 bytes long (e.g. ASTZ)
Space 20H	20H
Channel N°	Always "K0" for the analyzer
Space	20H (only if followed by data, otherwise <ETX>)
Data	Data bytes (depending on the command)
<ETX>	03H

Acknowledgement Command

Byte	Character	Explanation
1 st Byte	STX	ASCII Code 02
2 nd Byte	Don't Care	Any ASCII code
3 rd Byte	Function Code 1	Echo of the AK Instruction Command
4 th Byte	Function Code 2	Echo of the AK Instruction Command
5 th Byte	Function Code 3	Echo of the AK Instruction Command
6 th Byte	Function Code 4	Echo of the AK Instruction Command
7 th Byte	Blank	
8 th Byte	K	
9 th Byte	0	
10 th Byte	Blank	
	D	AK acknowledgement parameters; lengths variable
	A	AK acknowledgement parameters; lengths variable
	T	AK acknowledgement parameters; lengths variable
	A	AK acknowledgement parameters; lengths variable
nth Byte	ETX	ASCII Code 03

Example:

<STX>	02H Example: STZ 0 SREM STBY
Don't Care	Adjustable, factory setting 20H
Function Code	Same code as command package (e.g. ASTZ)
Space	20H
Status	0 without error or 1 to 9 when error (see also ASTF command)
Space	20H (only if followed by data, otherwise <ETX>)
Data	Parameter (depending on the command)
<ETX>	03H

Error Handling

It is possible that an unknown instruction is sent, the analyzer is busy with a function that is not the desired one, or an error occurred in the command parameters. The table below provides a summary of all errors that can appear upon any master instruction.

Analyzer's Acknowledgement	Explanation
??? f	Analyzer does not recognize the instruction sent.
xxxx f BS	Analyzer is busy with another function.
xxxx f SE	Syntax error within command parameters or incomplete command.
xxxx f NA	Requested function or data not available.
xxxx f DF	Data error: The kind or number of given parameters not valid.
xxxx f OF	Offline. The analyzer is offline, in local mode. Only inquiry commands and SREM (set analyzer in Remote Mode) are allowed.

NOTES:

1. f is the Error Status byte.
2. xxxx is the function code of the command being sent.

General AK Requirements

1. If the command message contains no error, the Acknowledge message contains the echo of the Function code and the Error Status number (0 to 9).
2. If the transfer was faulty or the function code is unknown, the answer contains four question marks (for example, ???? 0).
3. If the displayed value is not valid, a # symbol is placed in front of the measured value (for example, AIKG 0 #9999).
4. If a control or adjusting command is sent via the serial interface while the device is in Manual mode, it sends an answer like SLIN 0 K0 OF.
5. If a channel does not exist, the answer for control and adjusting commands is, for example, ATEM 0 3 NA. 3 is the number of the subchannel.
6. If the device is busy with a running function (for example, SLIN), every arriving control command is ignored (except SRES and STBY), and the response message is e.g. SMAN 0 BS. If in the SINT mode an additional SINT KO command is received, the integrator is reset to 0 and the integration is restarted.
7. If the command message contains data that the device cannot process (for example, ESYZ K0 ABC), the response message is ESYZ 0 SE. A syntax error is recognized if the data does not match the expected format or if the parameters do not fit the expected size.
8. Numbers are in floating-point format with decimal point. The decimal point can be dropped for integers.
9. If you switch from Manual to Remote, the device will remain in Manual mode until a SREM K0 is received by the control computer. On the display, this mode is indicated by REME (Remote Enable) on the Status line. In Manual mode, query commands via the serial interface are possible at any time.

Abbreviations

Abbreviation	Description
Mn	Measuring range number
Mn .. M4	Measuring range 1 .. 4
w.w .. ZZ.	Numerical value
x	Number
t	Numeric integer value
a0 .. a4	Polynomial coefficients
s	Status
Yymmdd	Date of format year, month and day with 2 characters each and no spaces
Hhmmss	Time of format hour, minute and second with 2 characters each and no spaces

In general, AK commands are subdivided into three classes:

- Scan commands (Axxx)
- Control commands (Sxxx)
- Configuration commands (Exxx)

Scan Commands

AAEG: Verifying Span-Point Deviation During Auto Calibration

Command	Response	Description
_AAEG_K0	_AAEG_s_M1_z.z_da_dr _M2_z.z_da_dr _M3_z.z_da_dr _M4_z.z_da_dr _O2_z.z_da.dr	Verifying deviations of ranges M1 to M4 and O ₂ with O ₂ option from span point stored after auto calibration. Values: measured value (z.z), absolute dev (da), relative dev (dr).

AANG: Verifying Zero-Point Deviation During Auto Calibration

Command	Response	Description
_AANG_K0	_AANG_s_M1_z.z_da_dr _M2_z.z_da_dr _M3_z.z_da_dr _M4_z.z_da_dr _O2_z.z_da_dr	Verifying deviations of ranges M1 to M4 and O ₂ with O ₂ option from zero point stored after auto calibration. Values: measured value (z.z), absolute dev (da), relative dev (dr).

AAOG: Applied Offsets and Gains

Command	Response	Description
_AAOG_K0_	_AAOG_s_M1_z.z_y.y _M2_z.z_y.y _M3_z.z_y.y _M4_z.z_y.y _O2_z.z_y.y	Offset and gain of ranges M1 to M4 and O ₂ with O ₂ option. z.z: Offset y.y: Gain

AATK: Query Auto Calibration Parameters

Command	Response	Description
_AATK_K0	_AATK_s_z_y_x	z: 1) NO mode 2) NO _x mode y: 1) ALL gases 2) Zero gas only x: 1) NO _x only 2) NO _x + O ₂ 3) O ₂ only

ADAL: Diagnostic Alarm Limits

Command	Response	Description
_ADAL_K0	_ADAL_s_a1.min_a1.max_... _a16.min_a16max	Sets all alarm limits (numbers and descriptions) <ol style="list-style-type: none"> 1. Sample pressure 2. Air pressure 3. Oven temperature 4. Converter temperature 5. Pump temperature 6. Diode temperature 7. Cell temperature 8. Peltier gas temperature 9. EPC coil sample voltage percent 10. EPC coil air / ozone voltage percent 11. Reserved 12. Concentration 1 / Concentration 2 13. O₂ detector temperature 14. Reserved 15. Reserved 16. O₂ Concentration 1 / Concentration 2
_ADAL_K0_x	_ADAL_s_x.min_x.max	Sets alarm limits of x (x = 1-16)

ADRU: Pressures / Electronic Pressure Control Valve Voltage in Percent

Command	Response	Description
_ADRU_K0	_ADRU_s_z.z_y.y_x.x.....	<ol style="list-style-type: none"> 1. Sample pressure 2. Air pressure 3. % of sample EPC volts 4. % of Ozone EPC volts
_ADRU_K0_x	_ADRU_s_xpress/x% voltage	Reading of x

ADUF: Flows

Command	Response	Description
_ADUF_K0	_ADUF_s_z.z_y.y	<ol style="list-style-type: none"> 1. Sample flow 2. Air flow
_ADUF_K0_x	_ADUF_s_xflow	Flow of x

AEFF: NO_x Correction Factors

Command	Response	Description
_AEFF_K0	_AEFF_s_z.z_y.y	zz: NO _x offset yy: NO _x correction factor

AEMB: Get Measuring Range

Command	Response	Description
_AEMB_K0	_AEMB_s_Mn	Current range n

AENT: Query Calibration Gas Flow Settings (Pumps or Valves)

Command	Response	Description
_AENT_K0	_AENT_s_x	x: 10 = Pump 11 = Valves

AFDA: Auto Calibration Times and Purge Time

Command	Response	Description
_AFDA_K0_SATK	_AFDA_s_z_y_x_w	Auto calibration times in seconds: z: Purge time y: Verify time x: Purge after time w: Calibrate time v: Total time
_AFDA_K0_SSPL	_AFDA_s_z	Purge time will be responded

AFGR: Default Factory Polynomial Coefficients

Command	Response	Description
_AFGR_K0_Mn	_AFGR_s_a0_a1_a2_a3_a4	Factory coefficients for range n
_AFGR_K1_M1	_AFGR_s_a0_a1_a2_a3_a4	K1 O ₂ option

AGRD: Polynomial Coefficients

Command	Response	Description
_AGRD_K0_Mn	_AGRD_s_a0_a1_a2_a3_a4	Polynomial coefficients of channel m Range n
_AGRD_K1_M1	_AGRD_a0_a1_a2_a3_a4	O ₂ coefficients with option

AGRW: Max Absolute / Relative Deviation Limits

Command	Response	Description
_AGRW_K0_Mn	_AGRW_s_z.z_y.y	z: Absolute y: Relative for range n
_AGRW_K1	_AGRW_s_z.z_y.y	K1 O ₂ option

AKAK: Calibration Gas Concentrations

Command	Response	Description
_AKAK_K0	_AKAK_s_M1_w.w _M2_x.x _M3_y.y _M4_z.z	All existing calibration gas values are responded.
_AKAK_K0_Mn	_AKAK_s_Mn_z.z	Calibration gas value of Range n
_AKAK_K1	_AKAK_s_M1_w.w	K1 is for O ₂ option

AKAL: Percent Deviations of Last Accepted Calibration

Command	Response	Description
_AKAL_K0_	_AKAL_s_M1_z.z_y.y_x.x_w.w _M2_z.z_y.y_x.x_w.w _M3_z.z_y.y_x.x_w.w _M4_z.z_y.y_x.x_w.w _02_z.z_y.y_x.x_w.w	Percent Deviation of ranges M1 to M4 and O ₂ with O ₂ option. z.z: Zero gas relative to last calibration y.y: Zero gas absolute to factory calibration x.x: Span gas relative to last calibration w.w: Span gas absolute to factory calibration

AKEN: Device Identification

Command	Response	Description
_AKEN_K0	_AKEN_s_devicename	Device identification is responded.
_AKEN_K1	_AKEN_s_model	Device model
_AKEN_K2	_AKEN_s_serial no	Device serial number
_AKEN_K3	_AKEN_s_Air pressure	Air pressure
_AKEN_K4	_AKEN_s_Sample pressure	Sample pressure

AKON: Measured Concentration Value

Command	Response	Description
_AKON_K0	_AKON_s_z.z_y.y_x.x_t	z.z : Current measured value y.y : NO concentration x.x : NO ₂ concentration w.w : NO _x concentration Note: y.y, x.x, and w.w are normally 0.0 when NO/NO _x /NO ₂ mode is selected. t = Timestamp (1/10 sec.)
_AKON_K1	_AKON_s_z.z_t	z.z : current measure value of channel 1. Channel 1 is O ₂ with option
_AKON_K4 _AKON_K5	_AKON_s_z.z_y.y_x.x_w.w_t	Current measure value for all 4 ranges based on their calibration offsets and gains. t = Timestamp (1/10 sec.)

AMBE: Measuring Range Limit

Command	Response	Description
_AMBE_K0	_AEMB_s_M1_w.w _M2_x.x _M3_y.y _M4_z.z	All existing measuring range limits.

AMBU: Upper and Lower Range Switchover Values for Auto Range

Command	Response	Description
_AMBU_K0	_AMBU_s_M1_w.w_W.W _M2_x.x_X.X _M3_y.y_Y.Y _M4_z.z_Z.Z	Lower and upper range switchover value of auto range.

APAR: Auto Calibration Tolerance Values

Command	Response	Description
_APAR_K0_SATK	_APAR_s_z.z_y.y_x.x_w.w	Auto calibration tolerance value (%): z.z: Range 1 y.y: Range 2 x.x: Range 3 w.w: Range 4

ARAW: Raw Detector Volts

Command	Response	Description
_ARAW_K0	_ARAW_s_z.z_t	Raw detector volts t = Timestamp (1/10 sec.)
_ARAW_K1	_ARAW_s_z.z_t	Raw detector volts, K1 for O ₂ with option. t = Timestamp (1/10 sec.)

ARMU: Raw Engineering Value

Command	Response	Description
_ARMU_K0	_ARMU_s_z.z_t	Raw engineering value before linearization, offset and span correction for t = Timestamp (1/10 sec.). These are the values used to calculate the polynomial coefficients.
_ARMU_K1	_ARMU_s_z.z_t	Raw engineering value before linearization, offset and span correction for Channel 1. These are the values used to calculate the polynomial coefficients. Channel 1 is O ₂ with option. t = Timestamp (1/10 sec.)

ASTF: Error Status

Command	Response	Description
_ASTF_K0	_ASTF_s_f1_f2_f3...f25	<p>Current error numbers of all are responded.</p> <ol style="list-style-type: none"> 1. Check sample pressure 2. Check air pressure 3. Check oven temperature 4. Check converter temperature 5. Check pump temperature 6. Check diode temperature 7. Check cell temperature 8. Check gas dryer temperature 9. Check O₂ temperature 10. Check sample EPC 11. Check air EPC 12. Range overflow 13. ADC range overflow 14. ADC range underflow 15. Range 1 calibration error 16. Range 2 calibration error 17. Range 3 calibration error 18. Range 4 calibration error 19. O₂ calibration error 20. Concentration 1 warning 21. Concentration 2 warning 22. O₂ ADC error 23. O₂ concentration 1 warning 24. O₂ concentration 2 warning 25. Dummy text for RTC time

ASTZ: Normal Device Status

Command	Response	Description
_ASTZ_K0	_ASTZ_s_State 1_State 2_ . . State 5	Respond device status for all channels.
Possible States	Response	Description
State 1	SREM SMAN	Remote Manual
State 2	STBY SPAU SMGA SNGA SO2Z SEGA SO2S SATK SNGA SATK SEGA SSPL	Standby Pause Measuring gas Zero gas NO Zero gas O ₂ option Span gas NO Span gas O ₂ option Zero gas during auto cal End gas during auto cal Purging / overflow
State 3	SENO SNOX S2NO SNO2	NO mode NO _x mode NO/NO _x /NO ₂ mode (NO) NO/NO _x /NO ₂ mode (NO _x)
State 4	SARE SARA	Auto range on Auto range off
State 5	SDRY SWET	Chiller in Chiller out

ASYZ: Respond System Time

Command	Response	Description
_ASYZ_K0	_ASYZ_s_yymmdd_hhmmss	System Time: yymmdd: year, month, day (each 2 characters wide, no spaces) hhmmss: hour, minute, second (each 2 characters wide, no spaces)

AT90: Respond Low-pass Filter Time

Command	Response	Description
_AT90_K0	_AT90_s_t	Low-pass filter time in seconds t = filter time in seconds

ATCP: Query TCP/IP Settings

Command	Response	Description
_ATCP_K0	_ATCP_s_ zzz.zzz.zzz.zzz _yyy.yyy.yyy.yyy _xxxx	zzz: TCP/IP address yyy: TCP/IP subnet mask xxxx: TCP/IP port

ATEM: Temperatures

Command	Response	Description
_ATEM_K0	_ATEM_s_z.z.y.y_x.x.....	<ol style="list-style-type: none"> 1. Oven temperature 2. Converter temperature 3. Pump temperature 4. Diode temperature 5. Cell temperature 6. Chiller temperature 7. O₂ detector temperature 8. Case temperature
_ATEM_K0_x	_ATEM_s_xtemp	Temperature of x

AUDP: Query UDP Data Streaming Parameter

Command	Response	Description
_AUDP_K0	_AUDP_s_<UDPPort> <DataFrequency>_ [<Mode>] _ [<UDP_IP>]	UDP port: opened for connection Data Frequency: transmission frequency of the data in Hz Mode: A: ASCII mode UDP_IP: alternative IP address open for the UDP connection when it should use the IP connected to the TCP/IP client.

AVER: Query Software Version

Command	Response	Description
_AVER_K0	_AVER_s_NMAIN_Z_mm.dd.yyyy_ NUSER_Y_mm.dd.yyyy_OSMSR_ X_dd.mm.yyyy	Z: NMAIN version build number Y: NUSER version build number X: OSMSR version build number dd: Day mm: Month yyyy: Year

Control Commands

SARA: Auto Range Off

Command	Response	Description
_SARA_K0	_SARA_s	Sets auto range off, CLD and FID

SARE: Auto Range On

Command	Response	Description
_SARE_K0	_SARE_s	Sets auto range on

SATK: Start Automatic Calibration

Command	Response	Description
_SATK_K0	_SATK_s	Start automatic calibration of all available ranges
_SATK_K0_Mn	_SATK_s	Start automatic calibration of range n

SEGA: Open Valve for Span Gas Calibration

Command	Response	Description
_SEGA_K0	_SNGA_s	Sets NO to span calibration mode
_SEGA_K1	_SNGA_s	Sets O ₂ to span calibration mode
_SEGA_K0_Mn	_SNGA_s	Open NO to span calibration mode Range n

SEKA: Saves Measured Value as New Span Value

Command	Response	Description
_SEKA_K0	_SEKA_s	Saves measured value of actual range as gain if Span mode is set
_SEKA_K1	_SEKA_s	Saves measured value as gain of O ₂ channel if O ₂ Span mode is set

SEMB: Set Measuring Range

Command	Response	Description
_SEMB_K0_Mn	_SEMB_s	Sets measuring range to range n. Auto range will be disabled

SENO: Sets NO Mode

Command	Response	Description
_SENO_K0	_SENO_s	Sets the measurement mode to NO only

SENT: Set Calibration Gas Flow (Pumps or Valves)

Command	Response	Description
_SENT_K0_X	_SENT_s	x: 10 = Pump 11 = Valves

SMAN: Manual Control to Control Device Manually

Command	Response	Description
_SMAN_K0	_SMAN_s	Sets analyzer in manual mode

SMGA: Start Measuring; Turn On Pumps if Fitted

Command	Response	Description
_SMGA_K0	_SMGA_s	Sets analyzer to measure mode

SNGA: Open Valve for Zero Gas Calibration

Command	Response	Description
_SNGA_K0	_SNGA_s	Sets NO to zero calibration mode
_SNGA_K1	_SNGA_s	Sets O ₂ zero calibration mode
_SNGA_K0_Mn	_SNGA_s	Sets NO to zero calibration mode for Range n

SNKA: Saves Measured Value as New Offset

Command	Response	Description
_SNKA_K0	_SNKA_s	Saves measured value of actual range as offset if Zero mode is set
_SNKA_K1	_SNKA_s	Saves measured value as offset of O ₂ channel if O ₂ Zero mode is set

SNOX: Sets NOx Mode

Command	Response	Description
_SNOX_K0	_SNOX_s	Sets the measurement mode to NOx only

SNO2: Sets NO/NOx/NO2 Mode

Command	Response	Description
_SNO2_K0	_SNO2_s	Sets the measurement mode to NO/NOx/NO ₂ . Automatic switching between NO and NOx modes

SPAU: Pause

Command	Response	Description
_SPAU_K0	_SPAU_s	Pause mode

SREM: Remote Mode for AK Commands

Command	Response	Description
_SREM_K0	_SREM_s	Sets analyzer in remote mode

SRES: Reset

Command	Response	Description
_SRES_K0	_SRES_s	Reset

SSPL: Purge Analyzer with Zero Gas

Command	Response	Description
_SSPL_K0	_SSPL_s	Opens purge gas valve

STBY: Standby

Command	Response	Description
_STBY_K0	_STBY_s	Standby mode

SUDP: Start/Stop UDP Data Streaming

Command	Response	Description
_SUDP_K0_ON	_SUDP_s	Starts data streaming via the UDP channel. Configure the channel before starting with EUDP command.
_SUDP_K0_OFF	_SUDP_s	Stops streaming via the UDP channel

SVZS: Reset Offset to 0 and Gain to 1

Command	Response	Description
_SVZS_K0	_SVZS_s	Sets all range offsets to 0 and all gains to 1
_SVZS_K1	_SVZS_s	Sets O ₂ range offsets to 0 and gains to 1

Configuration Commands

EATK: Set Auto Calibration Parameters

Command	Response	Description
_EATK_K0_z_y_x	_EATK_s_z_y_x	z: 1) NO mode 2) NO _x mode y: 1) ALL gases 2) Zero gas only x: 1) NO _x only 2) NO _x + O ₂ 3) O ₂ only

EDAL: Set Diagnostic Alarm Limits

Command	Response	Description
_EDAL_K0_al.min_ a1.max..._a16max	_EDAL_s	Sets all alarm limits (numbers and descriptions) <ol style="list-style-type: none"> 1. Sample pressure 2. Air pressure 3. Oven temperature 4. Converter temperature 5. Pump temperature 6. Diode temperature 7. Cell temperature 8. Peltier gas temperature 9. EPC coil sample voltage percent 10. EPC coil air / ozone voltage percent 11. Reserved 12. Concentration 1 / Concentration 2 13. O₂ detector temperature 14. Reserved 15. Reserved O ₂ Concentration 1 / Concentration 2
_EDAL_K0_x_ x.min_xmax	_EDAL_s	Sets alarm limit of x (x = 1-16)

EEFF: NO_x Offset and Correction Factor

Command	Response	Description
_EEFF_K0	_EEFF_s_z.z_y.y	zz: NO _x offset yy: NO _x correction factor

EFDA: Set Auto Calibration and Purge Times

Command	Response	Description
_EFDA_K0_SATK_ z_y_x	_EFDA_s	Sets auto calibration times: z: Purge time y: Verify time x: Purge after (z, y, x, w in seconds)
_EFDA_K0_ SSPL_z	_EFDA_s	Sets analyzer purge time to z seconds

EGRD: Set the Range Polynomial Coefficients

Command	Response	Description
_EGRD_K0_Mn_ A0_a1_a2_a3_a4	_EGRD_s	Sets the user polynomial coefficients for range n
_EGRD_K1_M1_ A0_a1_a2_a3_a4	_EGRD_s	Sets O ₂ polynomial coefficients

EGRW: Set Maximum Allowed Absolute / Relative Deviations

Command	Response	Description
_EGRW_K0_Mn	_EGRW_s_z_x	z: Absolute y: Relative
_EGRW_K1_Mn	_EGRW_s_z_x	K1 or option

EKAK: Set the Four Span Gas Concentration Values

Command	Response	Description
_EKAK_K0_M1_ w.w_M2_x.x_M3_ y.y_M4_z.z	_EKAK_s	Sets the NO span gas values
EKAK_K1_M1_ ww	_EKAK_s	Sets the O ₂ span gas values

EMBE: Set the Four Measuring Range Full scale Limits

Command	Response	Description
_EMBE_K0_M1_ w.w_M2_x.x_M3_ y.y_M4_z.z	_EMBE_s	Sets the range full scale limits

EMBU: Set the Upper and Lower Range Switchover for Auto Range

Command	Response	Description
_EMBU_K0_M1_ w.w_W.W_M2_x.x_ X.X_M3_y.y_Y.Y_ M4_z.z_Z.Z	_EMBU_s	Sets the lower and upper range switchover limits

EPAR: Set Auto Calibration Tolerance Values

Command	Response	Description
_EPAR_K0_SATK_ z.z_y.y_x.x_w.w	_EPAR_s	Auto calibration tolerance value (%): z.z = Range 1 y.y = Range 2 x.x = Range 3 w.w = Range 4

ESYZ: Set System Time

Command	Response	Description
_ESYZ_K0_ yymmdd_hhmmss	_ESYZ_s	Sets system time: yymmdd: year, month, day (each 2 characters wide, no spaces) hhmmss: hour, minutes, seconds (each 2 characters, no spaces)

ET90: Set Lowpass Filter Time

Command	Response	Description
_ET90_K0_t	_ET90_s	Sets lowpass filter time: t = filter time

ETCP: Set TCP/IP Parameters

Command	Response	Description
_ETCP_K0_ ZZZ.ZZZ.ZZZ.ZZZ_ yyy.yyy.yyy.yyy_XXXX	_ETCP_s	Zzz = TCP/IP address yyy = TCP/IP subnet mask xxxx = TCP/IP port All changes take effect after next Power On cycle.

EUDP: Set TCP/IP Data Streaming Parameters

Command	Response	Description
_EUDP_K0_<UDPPort>_ <DataFrequency>_ [<Mode>][<UDP_IP>]	_EUDP_s	Configures a UDP channel for data streaming of the measuring values via Ethernet UDP. Port: port for opening the UDP connection. Data Frequency: frequency for transmitting the data in Hz. Mode: A: ASCII mode (optional). UDP_IP: alternative IP address for opening the UDP connection when it should not be using the IP of the connected TCP/IP client (optional).

Data Format

DATA is any number of AK commands delimited by a semicolon (;). Replace underscores (_) in the AK command with a space.

If data is given, UDP_IP has to be set to a legal IP address or a hyphen (-) if default access should be used.

If data is omitted, "AKON K0" is used as default streaming data.

Format of the Streaming Data via UDP

ASCII Mode:

The measuring values will be sent with ASCII signs. The format is <sequence number> <data>

The sequence number will be incremented with every data packet that is sent.

<data> is the AK four-character code followed by the answer. See corresponding AK command description.

Example

Sending “EUDP K0 7001 2 A – AKON_KO;ADUF_K0” will give the following streaming result:

“123 AKON 4.07 901.33 22.50 3481639460 ADUF 4.30 4.59 4.45”, where 123 is the sequence number.

Modbus Protocol

Modbus on TCP/IP Application Data Unit

MBAP Description

This section describes the encapsulation of a Modbus request or a response when it is carried on a Modbus TCP/IP network.

A dedicated header, called the MBAP (Modbus Application Protocol) header, is used on TCP/IP to identify the Modbus Application Data Unit. This header provides some essential differences compared to the Modbus RTU application data unit used on the serial line:

1. The Modbus Slave Address field usually used on a Modbus Serial Line is replaced by a single-byte Unit Identifier within the MBAP Header. The Unit Identifier is used to communicate via devices such as bridges, routers and gateways that use a single IP address to support multiple independent Modbus end units.
2. All Modbus requests and responses are designed to allow the recipient to verify that a message is finished. For function codes on which the Modbus PDU has a fixed length, the function code alone is sufficient. For function codes carrying a variable amount of data in the request or response, the data field includes a byte count.
3. When Modbus is carried over TCP, additional length information is carried in the MBAP header to allow the recipient to recognize message boundaries even if the message has been split into multiple packets for transmission. The existence of explicit and implicit length rules and use of a CRC-32 error check code (on Ethernet) virtually eliminate the possibility of undetected corruption to a request or response message.

MBAP Header Description

The MBAP Header contains the following fields:

Field	Length	Description
Transaction Identifier	2 Bytes	Identification of a Modbus request / Response transaction
Protocol Identifier	2 Bytes	0 = Modbus
Length	2 Bytes	Number of following bytes
Unit Identifier (3)	1 Byte	Identification of a remote slave connected on a serial line or on other buses

The header is seven bytes long:

- **Transaction Identifier** – Used for transaction pairing, the Modbus server copies in the response the transaction identifier of the request.
- **Protocol Identifier** – Used for intra-system multiplexing. The Modbus protocol is identified by the value 0.
- **Length** - The Length field is a byte count of the following fields, including the Unit Identifier and Data fields.
- **Unit Identifier =3** – This field is used for intra-system routing. It is typically used to communicate to a Modbus+ or a Modbus serial line slave through a gateway between an Ethernet TCP-IP network and a Modbus serial line. This field is set by the Modbus client in the request and must be returned with the same value in the response by the server.

All Modbus/TCP ADU are sent via TCP to Registered Port 502.

The different fields are encoded in Big-endian. The 700 CLD analyzer uses only the Length bytes from the MBAP section.

Modbus Command Function Codes

Code 01

This function code is used to read from 1 to 2000 contiguous status bits in a remote device.

The requesting remote device specifies the starting address, including the address of the first bit specified and the number of bits. The device bits are addressed starting at zero. Therefore, bits numbered 1-16 are addressed as 0-15.

The bits in the response message are packed as one bit per bit of the data field. Status is indicated as 1 = ON and 0 = OFF. The LSB of the first data byte contains the output addressed in the query. The other bits follow toward the high order end of this byte, and from low order to high order in subsequent bytes.

If the returned output quantity is not a multiple of eight, the remaining bits in the final data byte will be padded with zeros (toward the high order end of the byte). The Byte Count field specifies the quantity of complete bytes of data.

Request

Function Code	1 Byte	0x01
Starting Address	2 Bytes	0x0000 to 0xFFFF
Quantity of Bits	2 Bytes	1 to 2000 (0x7D0)

Response

Function Code	1 Byte	0x01
Byte Count	1 Byte	N*
Bit Status	n Byte	n = N or N+1

*N = Quantity of Outputs / 8, if the remainder is different of 0 \Rightarrow N = N+1.

Error

Function Code	1 Byte	Function code + 0x80
Exception Code	1 Byte	01 or 02 or 03 or 04

Here is an example of a request to read discrete outputs 20–38:

Request		Response	
<i>Field Name</i>	<i>(Hex)</i>	<i>Field Name</i>	<i>(Hex)</i>
Function	01	Function	01
Starting Address Hi	00	Byte Count	03
Starting Address Lo	13	Status of Outputs 27-20	CD
Quantity of Outputs Hi	00	Status of Outputs 35-28	6B
Quantity of Outputs Lo	13	Status of Outputs 38-36	05

The status of outputs 27–20 is shown as the byte value CD hex, or binary 1100 1101. Output 27 is the MSB of this byte, and output 20 is the LSB.

By convention, bits within a byte are shown with the MSB to the left and the LSB to the right. Thus the outputs in the first byte are 27-20 from left to right. The next byte has outputs 35-28 left to right. As the bits are transmitted serially, they flow from LSB to MSB: 20 . . . 27, 28 . . . 35, and so on.

In the last data byte, the status of outputs 38-36 is shown as the byte value 05 hex, or binary 0000 0101. Output 38 is in the sixth bit position from the left, and output 36 is the LSB of this byte. The five remaining high-order bits are zero filled.

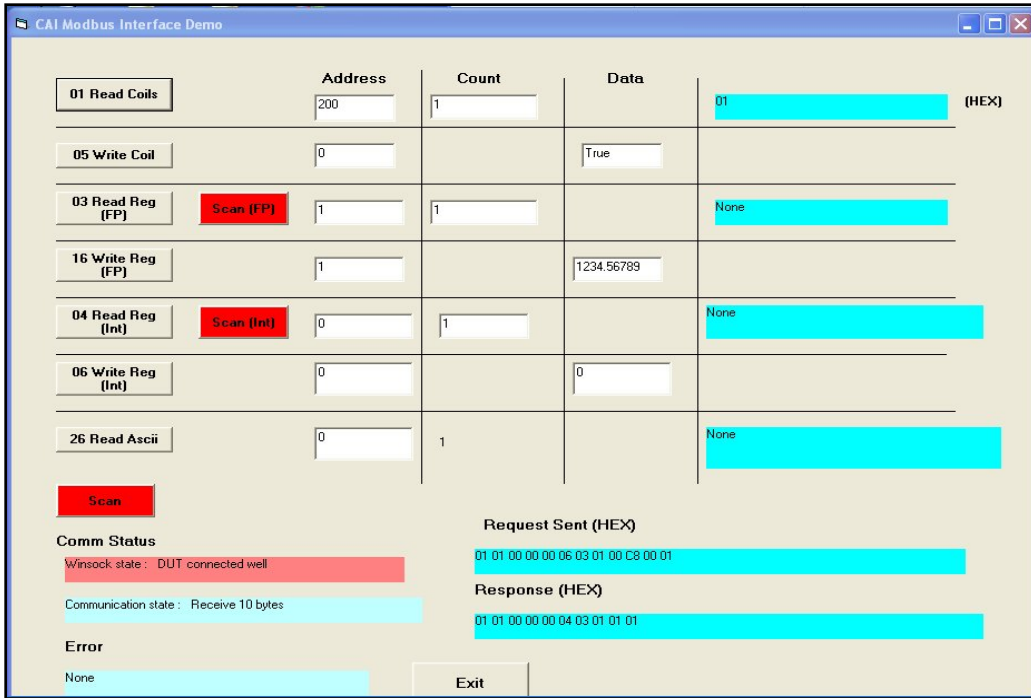

Command 01, Read Coil 200 Count 1. Result = 01.

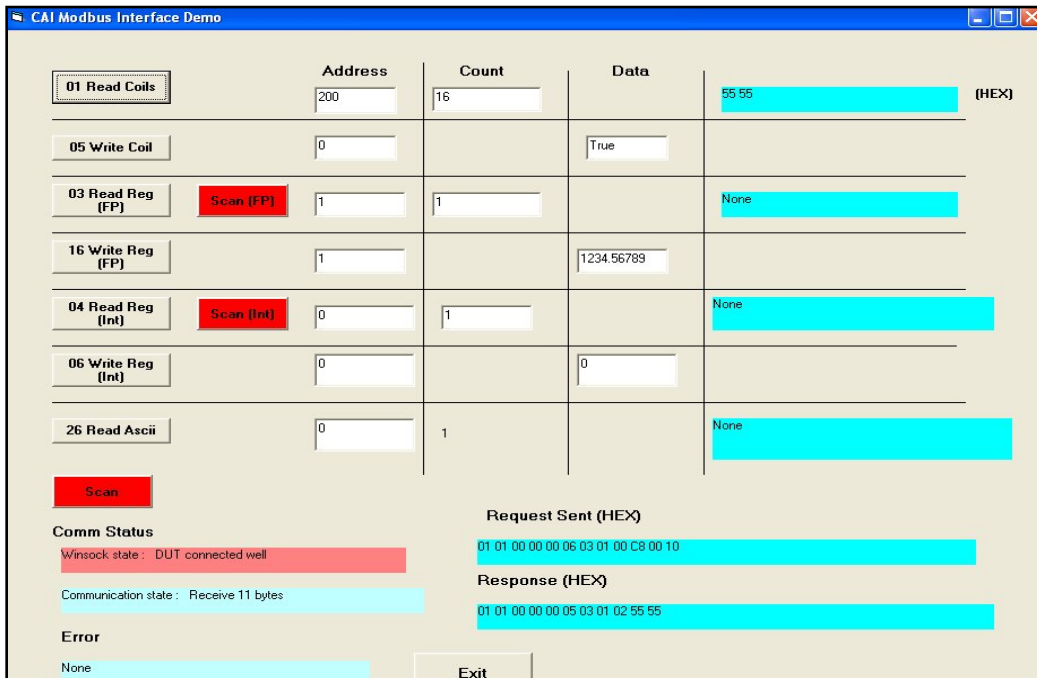

Command 01, Read Coil 200 Count 16. Result = 55 55 hex.

Code 03

This command has been modified to read floating-point numbers in 32-bit IEEE format.

This function code is used to read the contents of a contiguous block of floating-point registers in a remote device. The Request PDU specifies the starting register address and the number of registers. In the PDU, registers are addressed starting at zero. Therefore, registers numbered 1-16 are addressed as 0-15.

The register data in the response message are packed as four bytes per register, with the binary contents right justified within each byte. For each register, the first byte contains the high-order bits and the second byte contains the low-order bits.

Request

Function Code	1 Byte	0x03
Starting Address	2 Bytes	0x0000 to 0xFFFF
Quantity of Registers	2 Bytes	2 to 124 (0x7C)

Response

Function Code	1 Byte	0x03
Byte Count	1 Byte	2 x N*
Register Value	N* x 2 Bytes	

*N = Quantity of Registers

Here is an example of a request to read Register 0:

Request		Response	
<i>Field Name</i>	<i>(Hex)</i>	<i>Field Name</i>	<i>(Hex)</i>
Function	03	Function	03
Starting Address Hi	00	Byte Count	04
Starting Address Lo	00	Register Value Hi (1)	52
Number of Registers Hi	00	Register Value Lo (1)	2C
Number of Registers Lo	02	Register Value Hi (0)	44
		Register Value Lo (0)	9A

The contents of Register 0 are shown as the 4 byte values of 44 9A, 52 2C hex, or 1234.56789 decimal.

Here is an example of a request to read Register 40201:

Request		Response	
<i>Field Name</i>	<i>(Hex)</i>	<i>Field Name</i>	<i>(Hex)</i>
Function	03	Function	03
Starting Address Hi	9D	Byte Count	04
Starting Address Lo	09	Register Value Hi (40202)	33
Number of Registers Hi	00	Register Value Lo (40201)	33
Number of Registers Lo	02	Register Value Hi (40201)	41
		Register Value Lo (40201)	8F

The contents of register 40201 are shown as the 4 byte values of 41 8F 33 33 hex, or 17.9 decimal.

Here is an example of a request to read three registers starting at 40201:

Request		Response	
<i>Field Name</i>	<i>(Hex)</i>	<i>Field Name</i>	<i>(Hex)</i>
Function	03	Function	03
Starting Address Hi	9D	Byte Count	0C
Starting Address Lo	09	Register Value Hi (40202)	33
Number of Registers Hi	00	Register Value Lo (40201)	33
Number of Registers Lo	06	Register Value Hi (40201)	41
		Register Value Lo (40201)	8F
		Register Value Hi (40204)	33
		Register Value Lo (40204)	33
		Register Value Hi (40203)	41
		Register Value Lo (40203)	8F
		Register Value Hi (40206)	00
		Register Value Lo (40206)	00
		Register Value Hi (40205)	00
		Register Value Lo (40205)	00

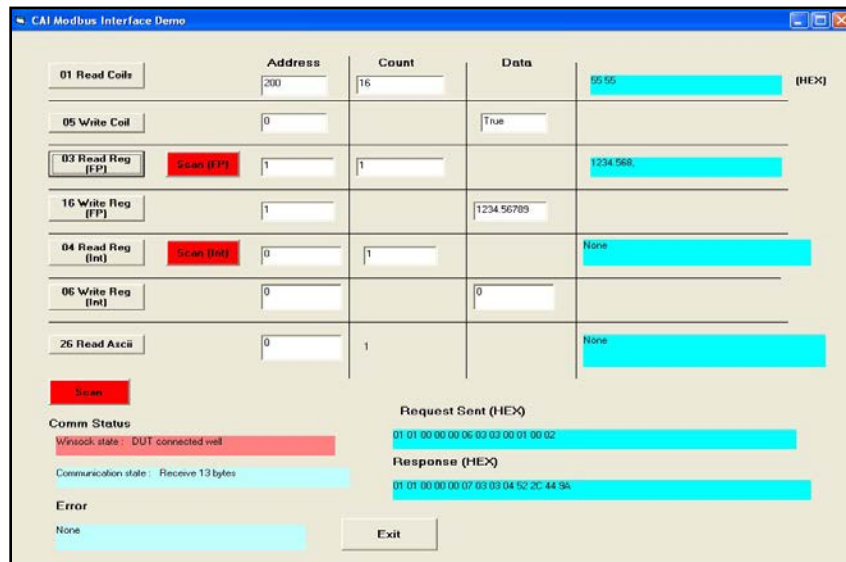

Command 03, Read Floating Point Value from Address 1. Result = 1234.56789.

Command	Address	Count	Data
01 Read Coils	200	16	55 55 (HEX)
05 Write Coil	0		True
03 Read Reg (FP)	1	4	1234.568, 0.0, -1234.568, 10000.0
16 Write Reg (FP)	1		1234.56789
04 Read Reg (Int)	0	1	None
06 Write Reg (Int)	0		0
26 Read Ascii	0	1	None

Comm Status
 Winsock state : DUT connected well
 Communication state : Receive 25 bytes

Request Sent (HEX)
 01 01 00 00 00 06 03 03 00 01 00 08

Response (HEX)
 01 01 00 00 00 13 03 03 10 52 2C 44 9A 00 00 00 00 52 2C C4 9A 40 00 46 1C

Error
 None

Buttons: Scan, Exit

Command 03, Read four Floating Point values starting at Address 1.

Result = 1234.56789, 0.0 -1234.568, 10000.

Code 04

This function code is used to read from 1 to 125 contiguous input registers in a remote device. The Request PDU specifies the starting register address and the number of registers. In the PDU, registers are addressed starting at zero. Therefore input registers numbered 1-16 are addressed as 0-15.

The register data in the response message are packed as two bytes per register, with the binary contents right justified within each byte. For each register, the first byte contains the high-order bits and the second byte contains the low-order bits.

Request

Function Code	1 Byte	0x04
Starting Address	2 Bytes	0x0000 to 0xFFFF
Quantity of Input Registers	2 Bytes	0x0001 to 0x007D

Response

Function Code	1 Byte	0x04
Byte Count	1 Byte	2 x N*
Input Registers	N* x 2 Bytes	

*N = Quantity of Registers

Here is an example of a request to read Input Register 8:

Request		Response	
Field Name	(Hex)	Field Name	(Hex)
Function	04	Function	04
Starting Address Hi	00	Byte Count	02
Starting Address Lo	08	Input Register 9 Hi	00
Quantity of Input Registers Hi	00	Input Register 9 Lo	0A
Quantity of Input Registers Lo	01		

The contents of Input Register 8 are shown as the two-byte values of 00 0A hex, or 10 decimal.

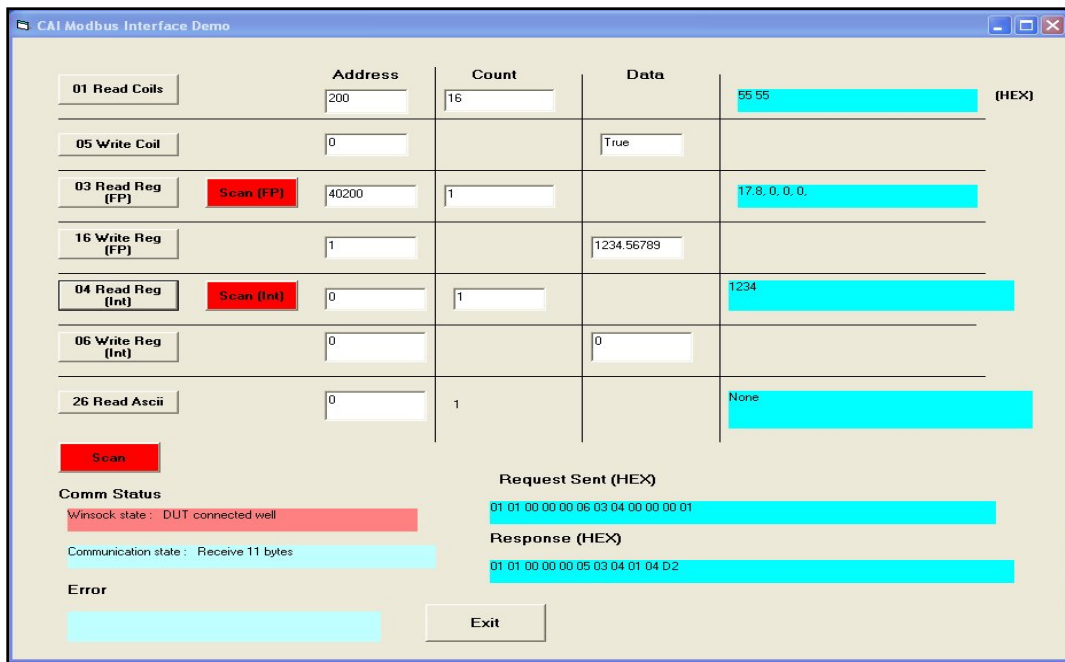

Command 04, Read one integer value from Address 0. Result = 1234.

Code 05

This function code is used to write a single output to either ON or OFF in a remote device.

The requested ON/OFF state is specified by a constant in the request data field. A value of FF 00 hex requests the output to be ON. A value of 00 00 requests it to be OFF. All other values are illegal and will not affect the output.

The Request PDU specifies the address of the bit to be forced. Bits are addressed starting at zero. Therefore the bit numbered 1 is addressed as 0. The requested ON/OFF state is specified by a constant in the Bit Value field. A value of 0xFF00 requests the bit to be ON. A value of 0x0000 requests the bit to be off. All other values are illegal and will not affect the bit.

The normal response is an echo of the request, returned after the bit state has been written.

Request

Function Code	1 Byte	0x05
Output Address	2 Bytes	0x0000 to 0xFFFF
Output Value	2 Bytes	0x0000 to 0xFF00

Response

Function Code	1 Byte	0x05
Output Address	2 Bytes	0x0000 to 0xFFFF
Input Registers	2 Bytes	0x0000 to 0xFF00

Here is an example of a request to write bit 173 ON:

Request		Response	
Field Name	(Hex)	Field Name	(Hex)
Function	05	Function	05
Output Address Hi	00	Output Address Hi	00
Output Address Lo	AC	Output Address Lo	AC
Output Value Hi	FF	Output Value Hi	FF
Output Value Lo	00	Output Value Lo	00

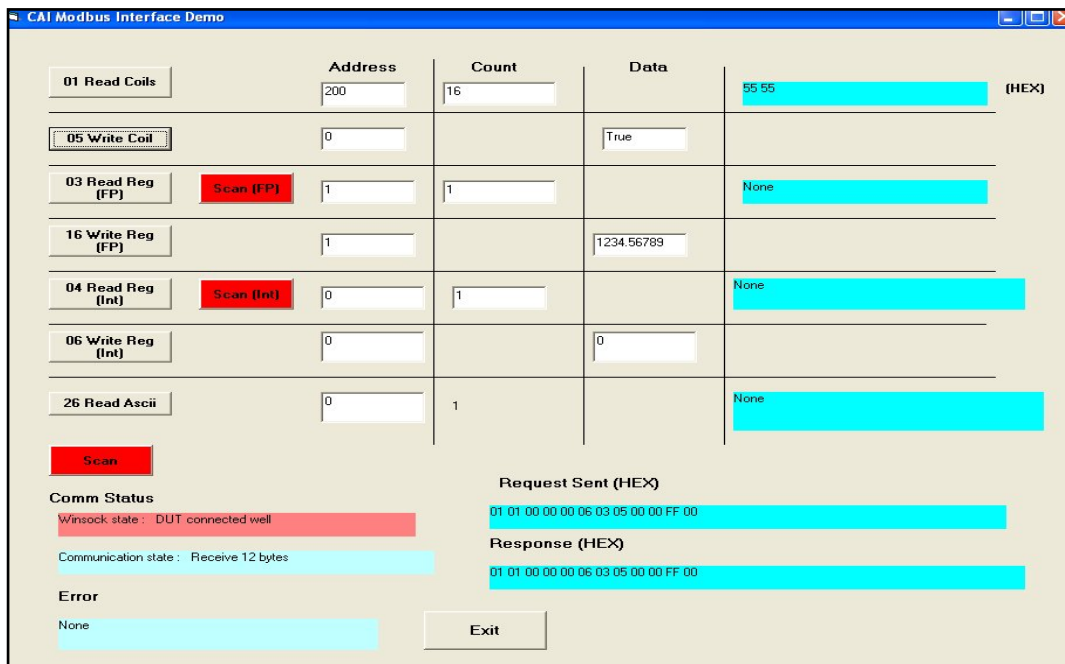

Command 05, Write a single-bit value (true) to Address 0.

Code 06

This function code is used to write a single holding register in a remote device. The Request PDU specifies the address of the register to be written. Registers are addressed starting at zero. Therefore the register numbered 1 is addressed as 0.

The normal response is an echo of the request, returned after the register contents have been written.

Request

Function Code	1 Byte	0x06
Output Address	2 Bytes	0x0000 to 0xFFFF
Output Value	2 Bytes	0x0000 to 0xFFFF

Response

Function Code	1 Byte	0x06
Output Address	2 Bytes	0x0000 to 0xFFFF
Input Registers	2 Bytes	0x0000 to 0xFF00

Error

Error Code	1 Byte	0x86
Exception Code	1 Byte	01 or 02 or 03 or 04

Here is an example of a request to write Register 1 to 00 03 hex:

Request		Response	
Field Name	(Hex)	Field Name	(Hex)
Function	06	Function	06
Register Address Hi	00	Register Address Hi	00
Register Address Lo	01	Register Address Lo	01
Register Value Hi	00	Register Value Hi	00
Register Value Lo	03	Register Value Lo	03

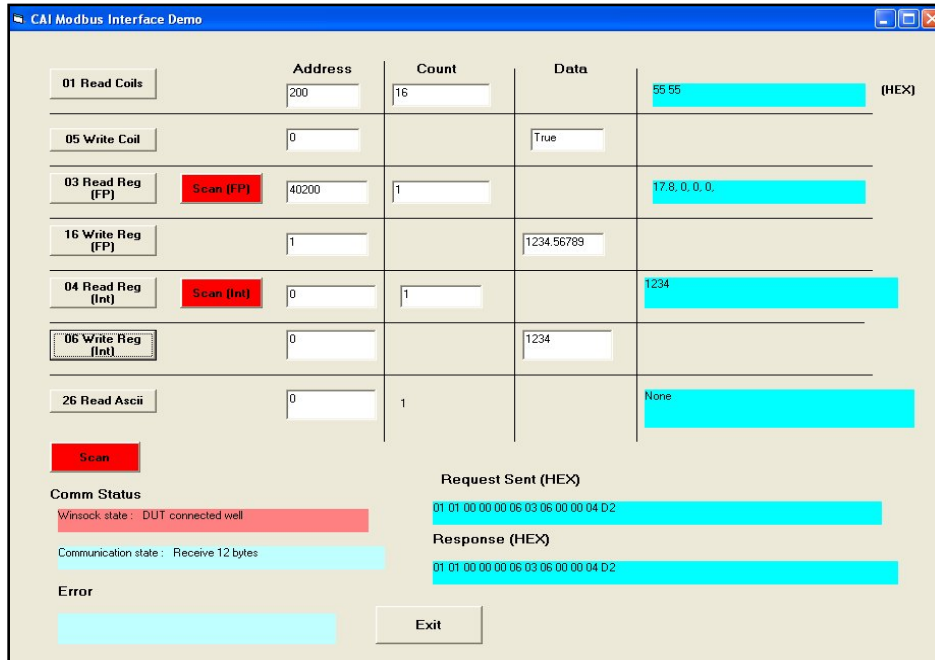

Command 06, write one holding register.

Code 16

This function code is used to write a single floating point register to a remote device.

The requested written values are specified in the request data field. Data is packed as four bytes per register. The normal response returns the function code, starting address and quantity of registers written. *The analyzer ignores the numbers in the register and byte count and expects four data bytes.*

Request

Function Code	1 Byte	0x10
Starting Address	2 Bytes	0x0000 to 0xFFFF
Quantity of Registers	2 Bytes	2
Byte Count	1 Byte	4
Registers Value	4 Bytes	value

Response

Function Code	1 Byte	0x10
Starting Address	2 Bytes	0x0000 to 0xFFFF
Quantity of Registers	2 Bytes	2

Error

Error Code	1 Byte	0x90
Exception Code	1 Byte	01 or 02 or 03 or 04

Here is an example of a request to write two registers starting at 2 to 00 0A and 01 02 hex:

Request		Response	
Field Name	(Hex)	Field Name	(Hex)
Function	10	Function	10
Starting Address Hi	00	Starting Address Hi	00
Starting Address Lo	01	Starting Address Lo	01
Quantity of Registers Hi	00	Quantity of Registers Hi	00
Quantity of Registers Lo	02	Quantity of Registers Lo	02
Byte Count	04		
Registers Value Hi	00		
Registers Value Lo	0A		
Registers Value Hi	01		
Registers Value Lo	02		

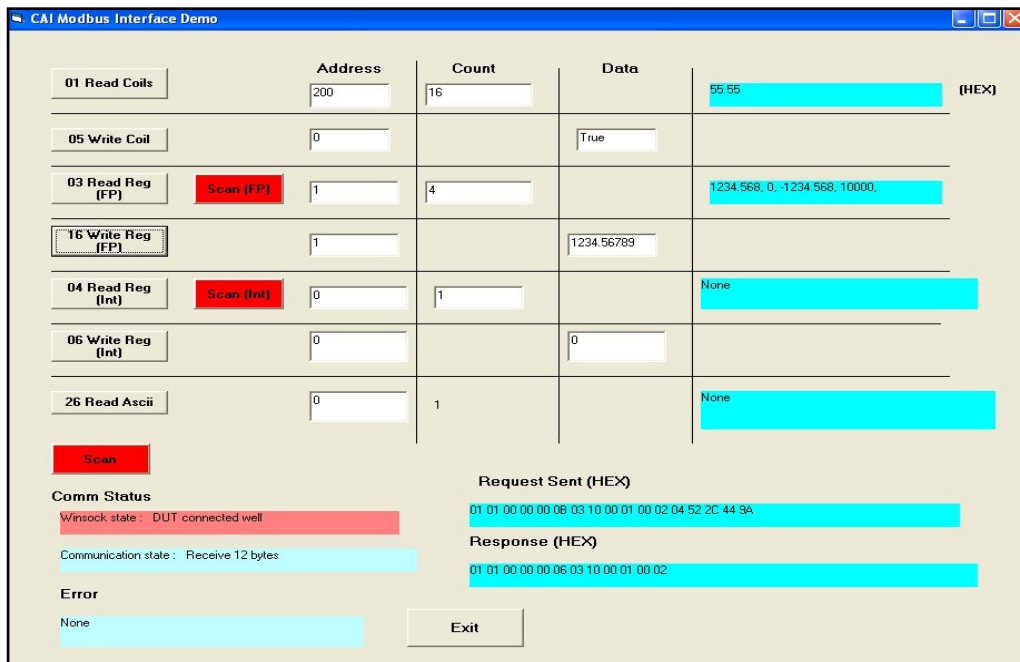

Command 16, Write one floating point register.

	Address	Count	Data	
01 Read Coils	200	16		55 55 (HEX)
05 Write Coil	0		True	
03 Read Reg (FP)	40200	1		17.8.0.0.0.
16 Write Reg (FP)	1		1234.56789	
04 Read Reg (Int)	0	1		None
06 Write Reg (Int)	0		0	
26 Read Ascii	0	1		None

Scan

Comm Status

Winsock state: DUT connected well

Communication state: Receive 9 bytes

Error

Request Sent (HEX)
01 01 00 00 00 06 03 03 9D 08 00 02

Response (HEX)
01 01 00 00 00 04 03 83 02

Exit

Command 16, Write one floating point register at Address 40200 showing error response.
Not a valid address.

Code 26

This is a non-standard code used to read an ASCII string.

Request

Function Code	1 Byte	0x1A
Starting Address	2 Bytes	0x0000 to 0xFFFF
Quantity of Registers	2 Bytes	1

Response

Function Code	1 Byte	0x1A
Length of String	1 Byte	0x00 to 0x7D
String	N Bytes	Data

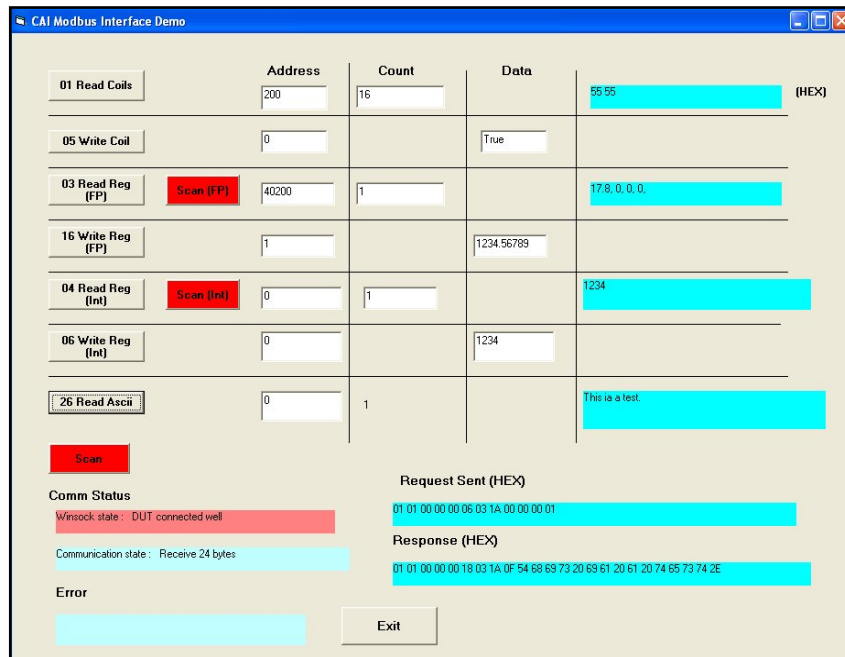

Command 26, Read ASCII string from Address 0.

Modbus Map

01H Single-Read Coil

Modbus Commands Use TCP/IP Port 502. (Do not change TCP/IP port from 7700.)

Coil Numbers and Descriptions

Coil Number	Read Data
1	Sample pressure
2	Air pressure
3	Oven temperature
4	Converter temperature
5	Pump temperature
6	Diode temperature
7	Cell temperature
8	Gas dryer temperature
9	O ₂ temperature (with option)
10	Sample EPV voltage
11	Air EPC voltage
12	Range overflow
13	ADC overflow
14	ADC underflow
15	Range 1 calibration error
16	Range 2 calibration error
17	Range 3 Calibration error
18	Range 4 Calibration error
19	Reaction chamber pressure (with option)
20	Low concentration
21	High concentration
32	General alarm
33	Eng units
37	For additional alarms and status

Coil Number	Read Data
101	0 – Manual, 1 – Remote
102	0 – Standby, 1 – Measure
103	1 – Zero
104	1 – Span
105	1 – AutoCal
106	1 – Purge
107	O ₂ 0 – Standby, 1 – Measure
108	O ₂ 1 – Zero
109	O ₂ 1 – Span
110	O ₂ 1 – AutoCal
115	0 – Via Pump, 1 – Via Valves
118	0 – Auto Off, 1 – Auto On
145	NO mode
146	NO _x mode
148	NO/NO _x /NO ₂ mode
150	Wet mode (with option)
151	Dry mode (with option)

05H Write Single Coil

Modbus Commands Use TCP/IP Port 502. (Do not change TCP/IP port from 7700.)

Coil Numbers and Descriptions

Coil Number	Write Data
101	0 – Manual, 1 – Remote
102	0 – Standby, 1 – Measure
103	1 – Zero
104	1 – Span
105	1 – AutoCal
106	1 - Purge
108	O ₂ 1 – Zero
109	O ₂ 1 – Span
115	0 – via Pump, 1 – via Valves
118	0 – Auto Off, 1 – Auto On
121	1 – Sets current range offset to 0.0
122	1 – Sets current range gain to 1.0
123	1 – Sets O ₂ offset to 0.0
124	1 – Sets O ₂ gain to 1.0
127	1 – Sets offset of range if zero gas
128	1 – Sets gain of range if span gas
129	1 – Sets O ₂ offset of range if zero gas
130	1 – Sets O ₂ gain of range if span gas
133	1 – Sets to Range 1
134	1 – Sets to Range 2
135	1 – Sets to Range 3
136	1 – Sets to Range 4
145	Sets NO mode
146	Sets NO _x mode
148	Sets NO/NO _x /NO ₂ mode
150	Sets Wet mode (with option)
151	Sets Dry mode (with option)

03H Read Floating Point

Modbus Commands Use TCP/IP Port 502. (Do not change TCP/IP port from 7700.)

Register Numbers and Descriptions

Register Number	Contents IEEE
40001	UNDILUTED real-time concentration* dilution ratio / 10000
40003	Real-time concentration (in ppm)
40005	Concentration before linearization and zero / span corrections
40007	Raw detector volts
40009	NO concentration – switching mode
40011	NO ₂ concentration – switching mode
40013	NO _x concentration – switching mode
40017	O ₂ concentration (with option)
40019	O ₂ concentration before linearization and zero / span corrections
40021	O ₂ raw detector volts (with option)
40025	Current range full-scale concentration
40027	O ₂ range – 25%
40031	Sample pressure
40033	Air pressure
40035	Oven temperature
40037	Converter temperature
40039	Pump temperature
40041	Diode temperature
40043	Cell temperature
40045	Gas dryer temperature (with option)
40047	O ₂ temperature (with option)
40049	Sample EPC coil voltage
40051	Air EPC coil voltage
40061	Range 1 offset

Register Number	Contents IEEE
40239	Converter temperature alarm minimum
40241	Converter temperature alarm maximum
40243	Pump temperature alarm minimum
40245	Pump temperature alarm maximum
40247	Diode temperature alarm minimum
40249	Diode temperature alarm maximum
40251	Cell temperature alarm minimum
40253	Cell Temperature alarm maximum
40255	Gas dryer temperature alarm minimum
40257	Gas dryer temperature alarm maximum
40259	Sample EPC voltage % alarm minimum
40261	Sample EPC voltage % alarm maximum
40263	Air EPC voltage % alarm minimum
40265	Air EPC voltage % alarm maximum
40267	O ₂ detector temperature alarm minimum
40269	O ₂ detector temperature alarm maximum
40287	Sample concentration alarm minimum
40289	Sample Concentration alarm maximum

16H Write Floating Point

Modbus Commands Use TCP/IP Port 502. (Do not change TCP/IP port from 7700.)

Register Numbers and Descriptions

Register Number	Contents IEEE
40201	Range 1 span gas concentration
40203	Range 2 span gas concentration
40205	Range 3 span gas concentration
40207	Range 4 span gas concentration
40209	O ₂ span gas concentration
40225	Dilution ratio
40227	Sample pressure alarm minimum
40229	Sample pressure alarm maximum
40231	Air pressure alarm minimum
40233	Air pressure alarm maximum
40235	Oven temperature alarm minimum
40237	Oven temperature alarm maximum
40239	Converter temperature alarm minimum
40241	Converter temperature alarm maximum
40243	Pump temperature alarm minimum
40245	Pump temperature alarm maximum
40247	Diode temperature alarm minimum
40249	Diode temperature alarm maximum
40251	Cell temperature Alarm Minimum
40253	Cell temperature alarm maximum
40255	Gas dryer temperature alarm minimum
40257	Gas dryer temperature alarm maximum
40259	Sample EPC voltage alarm minimum
40261	Sample EPC voltage alarm maximum
40263	Air EPC voltage alarm minimum
40265	Air EPC voltage alarm maximum

Register Number	Contents IEEE
40267	O ₂ detector temperature alarm minimum
40269	O ₂ detector temperature alarm maximum
40287	Sample concentration alarm minimum
40289	Sample concentration alarm maximum

Warranty Statement

Subject to the exceptions and upon the conditions stated below, California Analytical Instruments (CAI) warrants that the products sold under this sales order shall be free from defects in workmanship and materials for one year after delivery of the product to the original Buyer by CAI and if any such product should prove to be defective within such one year period, CAI agrees, at its option, either (i) to correct by repair or, at CAI's election, by replacement with equivalent product any such defective product, provided that investigation and factory inspection discloses that such defect developed under normal and proper uses, or (ii) to refund the purchase price. The exceptions and conditions mentioned above are as follows:

- a) components or accessories manufactured by CAI which by their nature are not intended to and will not function for one year are warranted only to give reasonable service for a reasonable time; which constitutes reasonable time and reasonable services shall be determined solely by CAI. A complete list of such components and accessories is maintained at the factory;
- b) CAI makes no warranty with respect to components or accessories not manufactured by it; in the event of defect in any such component or accessory CAI will give reasonable assistance to Buyer in obtaining from the respective manufacturer whatever adjustment is authorized by the manufacturer's warranty;
- c) any product claimed to be defective must be returned to the factory transportation charges prepaid and CAI will return the repaired or replaced product freight collect;
- d) if the product claimed to be defective requires on-site repair, such warranty labor will be provided at no charge; however, transportation and living expenses will be charged to Buyer;
- e) if the product is a consumable or the like, it is warranted only to conform to the quantity and content and for the period (but not in excess of one year) stated on the label at the time of delivery or 90 days;

- f) CAI may from time to time provide a special printed warranty with respect to a certain product, and where applicable, such warranty shall be deemed incorporated herein by reference;
- g) CAI shall be released from all obligations under all warranties, either expressed or implied, if any product covered hereby is repaired or modified by persons other than its own authorized service personnel unless such repair by others is made with the written consent of CAI.

IT IS EXPRESSLY AGREED THAT THE ABOVE WARRANTY SHALL BE IN LIEU OF ALL WARRANTIES OF FITNESS AND OF THE WARRANTY OF MERCHANTABILITY AND THAT CAI SHALL HAVE NO LIABILITY FOR SPECIAL OR CONSEQUENTIAL DAMAGES OF ANY KIND OR FROM ANY CAUSE WHATSOEVER ARISING OUT OF THE MANUFACTURE USE, SALE, HANDLING, REPAIR, MAINTENANCE OR REPLACEMENT OF ANY OF THE PRODUCTS SOLD UNDER THIS SALES ORDER. SOME STATES DO NOT ALLOW THE EXCLUSION OR LIMITATION OF INCIDENTAL OR CONSEQUENTIAL DAMAGES, SO THAT THE ABOVE LIMITATIONS OR EXCLUSIONS MAY NOT APPLY. THIS WARRANTY GIVES YOU SPECIFIC LEGAL RIGHTS, AND YOU MAY ALSO HAVE OTHER RIGHTS, WHICH VARY FROM STATE TO STATE.

Representations and warranties made by any person, including dealers and representatives of CAI, which are inconsistent, or in conflict with the terms of this warranty, shall not be binding upon CAI unless reduced to writing and approved by an expressly authorized officer of CAI.