



700 LX Series NDIR/O₂ Analyzer



Operators Manual

Table of Contents

Introduction	5
Operating Principle.....	7
Analyzer Specifications.....	8
Installation	9
Safety Information	9
Unpacking Instructions.....	11
Site Selection and Mounting	12
Sampling Requirements.....	16
Startup and Shutdown	17
Using the Keypad.....	19
Menu Flow Chart.....	21
Main Menu	29
Measure Screen.....	30
Change Channel	33
Analyzer Info	34
Remote/Manual	35
Standby.....	36
Menus	37
Calibration	38
Manual Calibration.....	39
Zero	40
Span.....	43
Automated Calibration	45
Initiate Sequenced Cal.....	47
Initiate Sequenced Check	49
Cal Gas Concentrations.....	50
Calibration Setup.....	51
Auto Calibration Schedule	52
Auto Calibration Parameters	54
Calibration Via Pump/Valves	56
Auto Calibration/Check	57
Auto Calibration Timing	58
Deviation Limits.....	60
Maximum Calibration Error.....	61
Maximum Verifying Error	62
Analog Hold on Cal	63
Calibration Factors	64
Manual Deviations	65
Zero Gas Deviations.....	66
Span Gas Deviations	67
Auto Cal Deviations	68
Zero Gas Deviations Verifying	69
Span Gas Deviations Verifying.....	70
Offset/Gain Factors	71

Reset Factory Settings.....	72
Range Setup	77
Range Limits	78
Auto Range On/Off.....	80
AutoRange Switch Points	81
Diagnostics	82
Diagnostic Values	83
Raw Values Display.....	86
I/O Status.....	88
Analyzer Digital Outputs	89
Analyzer Digital Inputs	90
Programmable Digital Outputs.....	91
Status Line.....	92
Setup Menu	93
Measure Settings	94
Averaging Time	95
Comp Factors	96
Temperature Compensation	97
Pressure Compensation	98
H ₂ O Compensation.....	99
Gas Compensation	100
Output Settings.....	101
Programmable Analogs.....	102
Output Assignments	103
Output Scaling.....	105
Output Adjustments	107
Programmable Digitals.....	109
Output Assignments	110
Output Hold/Clear	113
Output Test.....	114
TCP/IP Parameters	116
Data Logging Time	117
Auto Start Settings	118
Clock Settings	120
Alarms Menu	121
Current Alarms.....	122
Alarm Log	123
Alarm Limits.....	124
Temperatures.....	125
Pressures.....	126
Voltages.....	127
Concentrations.....	128
Alarm Display On/Off.....	129
Linear Coefficients.....	131
Service Menu	133
Temperature Set Points	134
Pressure Set Points	135
Amplifier Setpoint.....	136
Security.....	137
Operator Levels.....	138
Change Password	139

Reset Password.....	140
Communication and Interface	141
Analog and Digital Interface	142
Serial Interface	146
AK Protocol.....	147
Instruction Command.....	149
Acknowledgement Command.....	150
Error Handling	151
General AK Requirements	152
Scan Commands.....	154
Control Commands	165
Configuration Commands	169
Modbus Protocol.....	175
MBAP Description.....	175
MBAP Header Description	176
Modbus Command Function Codes.....	177
Modbus Map	194
01H Single-Read Coil	194
05H Write Single Coil.....	196
03H Read Floating Point.....	198
16H Write Floating Point	203
Warranty Statement	205

REMOTE WEB INTERFACE CAPABILITY

The 700LX Series provides the end-user with the ability to remotely interface with the analyzer via a web browser. No custom software is necessary to be installed to connect to the 700LX Series Analyzer from your PC or mobile device. (It is suggested that you use the Google Chrome web browser.)

Visit https://www.gasanalyzers.com/gas_analyzers/non-dispersive-infrared-ndir-analyzers for the Web Interface instruction manual.

Introduction



Thank you for purchasing the CAI 700LX NDIR/O₂ analyzer. Before using the analyzer, please familiarize yourself with its operation by reading this manual. If you have any questions, please do not hesitate to call California Analytical Instruments Technical Support for assistance. We want you to be among our thousands of satisfied customers.

Description

The 700LX NDIR/O₂ analyzer is based on the infrared absorption characteristics of gases. The analyzer's oxygen channel utilizes either the paramagnetic or electrochemical fuel-cell method to determine the percent level of oxygen contained in the sample gas.

Features

- Measures IR from low ppm up to 100% Full Scale and oxygen from 0-1% to 0-100%
- Multiple channels – up to three NDIR channels or two NDIR channels plus oxygen
- Auto calibration and ranging
- Fast response time
- Temperature and pressure compensation

- Comprehensive diagnostics
- CE Mark and ETL listed – conforms to UL STD 61010-1, certified to CAN/CSA C22.2 STD No. 610610.1
- 1065-compliant configurations

Options

- Paramagnetic or electrochemical oxygen channel
- Oxygen channel-only configuration
- Internal sample pump
- Sample flow control
- Multiple sample inputs
- 19” rack-mount slides
- Output options: Voltage, Current, RS-232 AK protocol, TCP/IP Modbus and AK protocol

Operating Principle

The CAI 700LX NDIR/O₂ analyzer is based on the infrared absorption characteristics of gases. Using a single infrared beam to measure gas concentrations, this analyzer delivers highly stable and reliable results.

A single infrared light beam is modulated by a chopper system and passed through a sample cell of predetermined length containing the gas sample to be analyzed. As the beam passes through the cell, the sample gas absorbs some of its energy. The attenuated beam (transmittance) emerges from the cell and is introduced into the front chamber of a two-chamber infrared microflow detector. The detector is filled with the gas component of interest, and consequently the beam experiences further energy absorption. This absorption process increases the pressure in both chambers.

The differential pressure between the front and rear chambers of the detector causes a slight gas flow between the two chambers. This flow is detected by a mass-flow sensor and is converted into an output signal.

The 700LX NDIR/O₂ analyzer's oxygen channel utilizes either the paramagnetic or electrochemical fuel-cell method to determine the percent level of oxygen contained in the sample gas. The oxygen level is displayed on the LCD panel in percent concentration.

Analyzer Specifications

Specifications are subject to change without notice.

IR Analysis Method: Non-dispersive infrared (NDIR)

NDIR Components: CO, CO₂, CH₄, SO₂, NO

Detector Type: Microflow

NDIR Ranges : From 0-50 ppm up to 0-100%

Range Ratio: 10:1

Response Time (IR): 90% of Full Scale in < 2 second, depending on cell length, flow rate and time constant

IR Sample Cell: Stainless steel w/ replaceable gold cell liner

Resolution: Typically 0.1% of Full Scale

Repeatability: Better than 1.0% of Full Scale

Linearity: Better than 1.0% of Full Scale of factory-calibrated ranges

Noise: Less than 1% of Full Scale of factory-calibrated ranges

Zero and Span Drift: Less than 1% of Full Scale per 24 hours

Sample Flow Rate: 0.5 to 2.0 LPM

Oxygen Analysis Method: Paramagnetic or Electrochemical Fuel Cell

O₂ Ranges: 0-1% (paramagnetic only) up to 0-100% O₂ Full Scale; four definable ranges

O₂ Response Time: T90 - 2 seconds paramagnetic; 16 seconds fuel cell

Outputs Available: Voltage, current, TCP/IP, RS-232, Modbus

Display: 3" x 5" backlit LCD

Sample Temperature: Up to 50°C, non-condensing

Ambient Temperature: 5 to 40°C

Ambient Humidity: Less than 90% RH (non-condensing)

Fittings: ¼-inch tube

Power Requirements: 115/230 (± 10%) VAC; 50/60Hz; 300 Watts maximum

Dimensions: 5¼"H x 19"W x 23"D

Weight: 30-45 lbs., depending on configuration

Installation

Safety Information



Safety Alert
Caution or Warning



Temperature Hazard
Caution or Warning



Electrical Shock Hazard
Caution or Warning

Note, Caution and Warning symbols appear on the instrument and in this manual to draw your attention to important operational and safety information.

A “**NOTE**” marks a short message to alert you to an important detail.

A “**CAUTION**” safety alert appears with information that is important for protecting your equipment and its performance.

A “**WARNING**” safety alert appears with information that is important for protecting you, other people and equipment from damage. Pay especially close attention to all warnings that apply to your application.



The  symbol (an exclamation point in a triangle) precedes a general CAUTION or WARNING statement.



The  symbol (wavy vertical lines with an underscore in a triangle) precedes an elevated temperature hazard CAUTION or WARNING statement.



The  symbol (a lightning bolt in a triangle) precedes an electrical shock hazard CAUTION or WARNING statement.

Some or all of the above symbols may appear in this manual or on the equipment. This manual should be consulted whenever one of these symbols is encountered on the equipment.

**ALWAYS REMOVE POWER BEFORE CONNECTING OR DISCONNECTING
SIGNAL CABLES OR WHEN SERVICING THE EQUIPMENT.**

Unpacking Instructions

Open the shipping container and carefully remove the analyzer from the packing materials. Inspect the instrument for any sign of damage. Remove the top-cover retaining screws. Visually check for loose parts or connectors that are not properly seated. Verify that all circuit boards and circuit board connections are secure. If all internal components and their alignments look correct, re-install the cover.

IMPORTANT: You should save the original shipping container your analyzer arrives in. The shipping container and packaging are specially designed to protect the analyzer in transport. If you ever need to return the analyzer to CAI for repair or any other reason, the original shipping container and packaging should be used.

Reporting Damage

Should there be any apparent damage to either the inside or outside of the instrument due to shipping or handling, immediately notify the shipping company and CAI. The shipping container or packing materials should be retained for inspection by the shipper.

Contact Information

California Analytical Instruments, Inc.

1312 West Grove Avenue

Orange, CA 92865

714-974-5560

714-921-2531

www.gasanalyzers.com

Site Selection and Mounting



CAUTION: *The following precautions must be carefully observed:*

1. Select a site free from direct sunlight, radiation from a high-temperature surface, or abrupt temperature variations.
2. This analyzer is *not* suitable for installation outdoors.
3. Select a site where the air is clean. Avoid exposing the instrument to corrosive or combustible gases.
4. The instrument must not be subject to severe vibration. If severe vibration is present, use isolation mounts.
5. The instrument is designed for rack mounting. Optional rack-mount slides are available.
6. Do not install the CAI 700LX NDIR/O₂ analyzer near equipment that emits electromagnetic interference (EMI).

NOTE: *A front and rear supporting brace or equivalent is required if the optional rack mount slides were not purchased.*



The Power On/Off switch is accessible from the rear of the analyzer only. **DO NOT** mount the analyzer in a manner that leaves the Power On/Off switch inaccessible.

Rack Mounting

The front panel is designed for mounting into a standard 19-inch rack enclosure. Holes are located on the left and right side to allow the panel to be secured in the rack by screws. Optional rack slides allow the analyzer to be pulled out of the rack enclosure for access.

Rear Panel

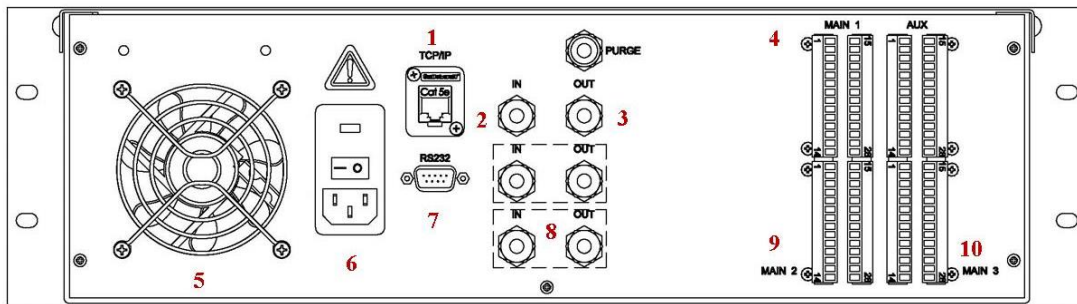

The rear panel includes the following:

1. TCP/IP connection to connect network connector.
2. Sample Gas inlet for introducing sample gas into the analyzer (1/4-inch tube).
3. Sample Gas outlet (vent) for exhaust of sample gas (1/4-inch tube).
4. 28-pin output terminal strip/Main 1 (standard).
5. Analyzer Cooling Fan
6. Power Entry module for power connection, power switch, fuse compartment.
7. Serial connection to connect serial connector cable.
8. Inlet/Outlet Gas Connections for Additional Channels
9. 28-pin output terminal strip/Main 2
10. 28-pin output terminal strip/main 3

Electrical

All wiring is connected at the rear of the analyzer. The AC power cord is connected to the power entry as shown below:

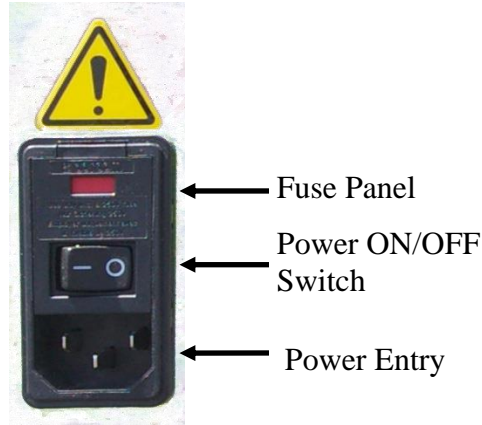

AC Power Switch, Connector and Fuse.

NOTE: A defective ground may affect the analyzer's operation. Shielded wiring is recommended for output signals.

Output Connections

See the [Analog and Digital Interface](#) section of this manual for instructions for the various output selection options. Shielded wiring is recommended for output signals.

Recommended Gases

1. Nitrogen (or zero air) in a pressurized cylinder.
2. Standard span gas near full-scale concentration with a nitrogen balance, in a pressurized, certified cylinder.

Pressure regulators for zero and span gas cylinders and corrosive-resistant gas tubing are also recommended.

Zero calibration for the 700LX NDIR/O₂ Analyzer requires ultra-high-purity nitrogen (UHP N₂) or calibration-grade air, plus a span gas near the full-scale range of the infrared channel.

Calibration gases can be delivered through either the calibration ports on the back of the analyzer (if optional solenoid valves have been installed) or through the sample inlet.

Gases introduced through a calibration port should be at 10-25 PSIG. If introduced through the sample port, pressures should be as follows:

1. Without sample pump, pressure should be 2-10 PSIG. (Customer controlled flow)
2. With sample pump – no pressure.
3. With internal EPC flow control 10-25 PSIG

Gas Handling Equipment

Pressure regulators for zero gas (air or N₂) and span gas cylinders are required for gas analysis using the 700LX NDIR/O₂ Analyzer.

Gas Connections

If the calibration gases are not connected to calibration inlets on the back of the analyzer (if optional solenoid valves have been installed), the cal gases will need to be delivered through the sample port at the pressure settings listed above.

The tubing from the sampling system to the gas analyzer should be made from corrosive-resistant material such as Teflon[®] or Stainless Steel. Rubber or soft vinyl tubing should not be used since readings may be inaccurate due to gas absorption into the tubing material. For fast response, the tubing should be as short as possible. Optimum tube internal diameter is 0.16 inch (4 mm). Couplings to the instrument are ¼-inch tube.



CAUTION: Be sure tubing and joints are clean. Dust entering the instrument may cause it to malfunction.

Sampling Requirements

Filtration

Dust must be eliminated completely. Use filters as necessary. The final filter must be capable of removing particles larger than 4 microns.

Condensation

Dew point of the sample gases must be lower than the instrument temperature to prevent accidental condensation within the instrument. Bypass the sample through a dehumidifier to reduce the dew point to about 2 to 4° C or less. If the sample contains an acid mist, use an acid mist filter, cooler or similar device to remove all traces of the mist.

Presence of Corrosive Gases

High concentrations of corrosive gases such as Cl₂, SO₂, F₂, HCl, in the sample gas shorten the useful service life of the instrument.

Gas Temperature

Do not exceed the maximum rating of the instrument 104° F (50° C) when measuring high temperature gases.

Sample Gas Bypass Outlet (Vent)

A sample gas bypass outlet connector is located on the rear panel (¼ Inch Tube). Pressure at this outlet should be kept at atmospheric level. ANY backpressure will cause an error in reading.



CAUTION: *If the analyzer contains an optional internal sample pump, the introduction of a pressurized sample gas in excess of 1.5 PSIG will damage the pump.*

Startup and Shutdown

Before using the analyzer, make sure the external plumbing and wiring have been connected correctly as shown in the Rear Panel description. All connections should be leak-tight, and inlet pressure settings adjusted as previously described.

NOTE: Make sure the proper connections for the vents for the reaction chamber and sample have been made prior to powering on the analyzer, since ozone will be flowing from these vents.

Turn on the Power switch on the analyzer's rear panel. After a short delay, the digital display should illuminate. If the display does not come on, check the power source and the fuse. If the problem persists, call CAI Technical Support.

Refer to the [Using the Keypad](#) section and review the complete Operator's Manual for detailed instructions for proper setup and operation of the 700LX NDIR/O₂ Analyzer.

Shutdown Procedure

1. Turn off the valves on the zero, span and air cylinders.
2. If the analyzer contains the optional internal sample pump, disconnect the sample line from the rear inlet port. **Do NOT turn off the sample pump or analyzer power at this point. Any pressurization of the pump could cause damage.**
3. Allow the analyzer to draw in room air for approximately 10 minutes or flush out any remaining sample that could cause condensation as the analyzer cools.
4. Turn off the optional internal sample pump by setting the analyzer to [Standby](#).
5. Turn off the analyzer power.

Proper Storage

After powering down, allow the heated analyzer components to cool to room temperature before preparing for storage.

If the original shipping box was retained, the analyzer should be stored in the box in the packing material supplied. If the original box is not available and another appropriate box cannot be obtained, the analyzer can be placed in a clean, dry plastic bag.

Storage should be in a reasonably temperature-controlled environment and away from any possible exposure to dust and water or other liquids.

Using the Keypad

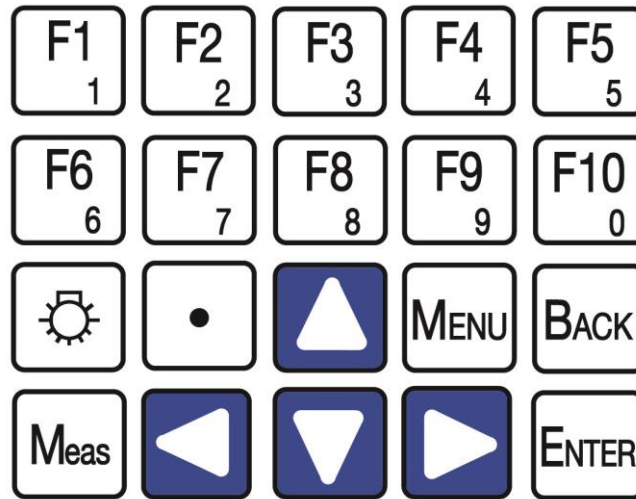

When the Measure screen is displayed, the ten **Function keys (F1 through F10)** are shortcuts to commonly used screens. On other screens, these keys can either be used as function keys or to enter numeric values. This is why each number key includes both the larger **Function number** at the top (for example, F1) and the smaller number underneath for **numeric value** (for example, 1). 



The Light key is used to turn the display's backlight on and off.



The Decimal Point key is used to enter a decimal point when a numeric value is keyed in.



The Menu key is used to bring you to the Main Menu at any time.



The Back key is used to return to the previous screen.



From any screen, the Measure key takes you to the Measure screen. The current measurement is being displayed.





The Enter key:



1. In Function mode, the Enter key selects the highlighted function.
2. When a field is highlighted for numeric input, pressing the Enter key opens the selected field for numeric entry with a blinking cursor. Pressing the Enter key a second time exits the Numeric Entry field.

An **N** will be displayed in the bottom-right corner of the screen when the analyzer is in **Numeric Entry** mode. An **F** is displayed when the analyzer is being used for **Function** mode.



In Function mode, the **arrow keys** move the highlight. Press the Enter key to accept the highlighted function. In Numeric mode these keys control the cursor. Arrow key functions will vary as is shown on some screens.

In Numeric mode, the left and right arrow keys   allow you to move the blinking cursor.

The up and down arrow keys   change the value within a field that has the cursor underneath it. The arrow keys are also used to scroll the input possibilities and edit the numbers.

Menu Flow Chart

The Menu Flow Chart is a handy reference that will help you familiarize yourself with the operation of the CAI 700LX NDIR/O₂ Analyzer. Start by pressing  to access the Main Menu to quickly find any screen.

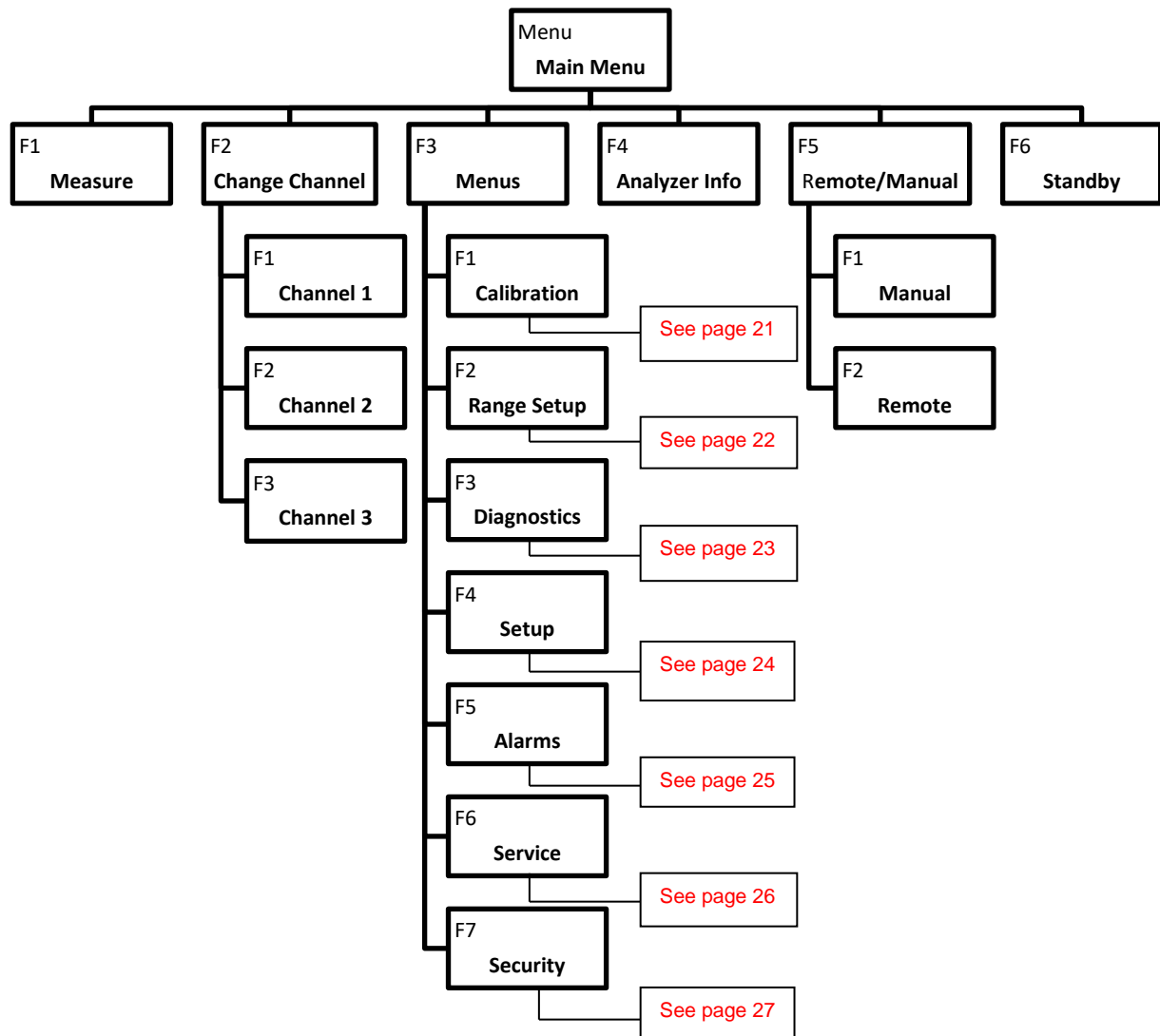

Calibration

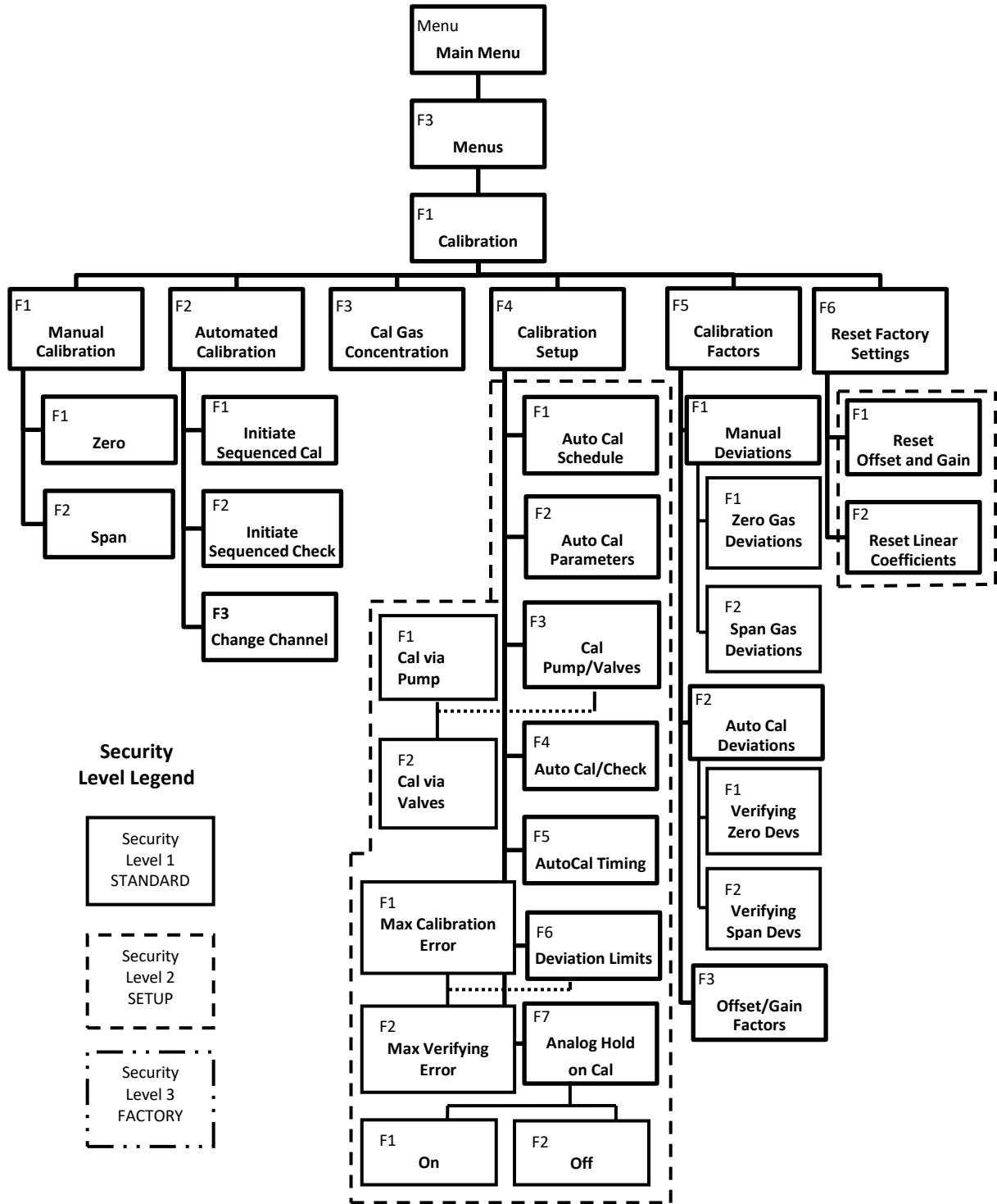

Range Setup

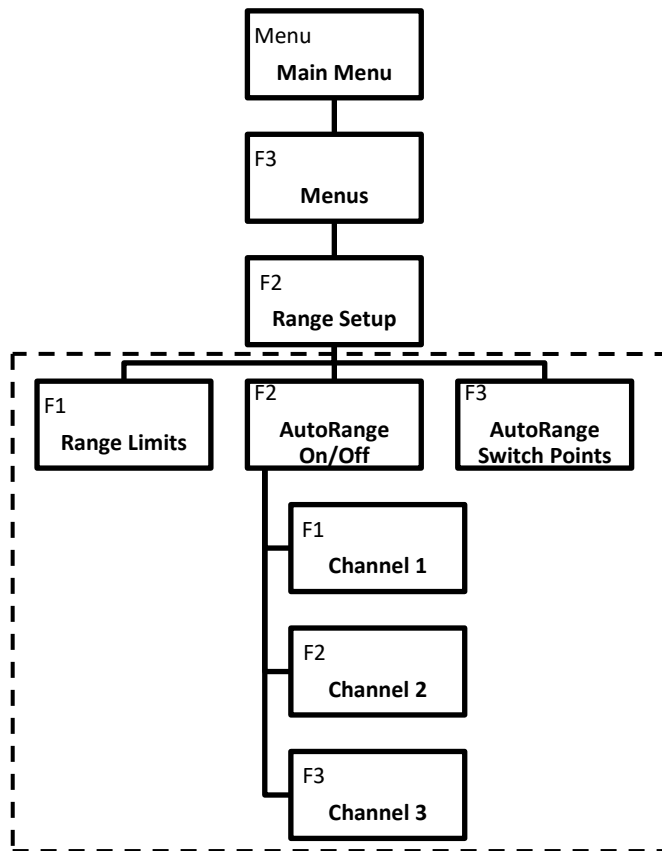

Security Level Legend

Security Level 1
STANDARD

Security Level 2
SETUP

Security Level 3
FACTORY

Diagnostics

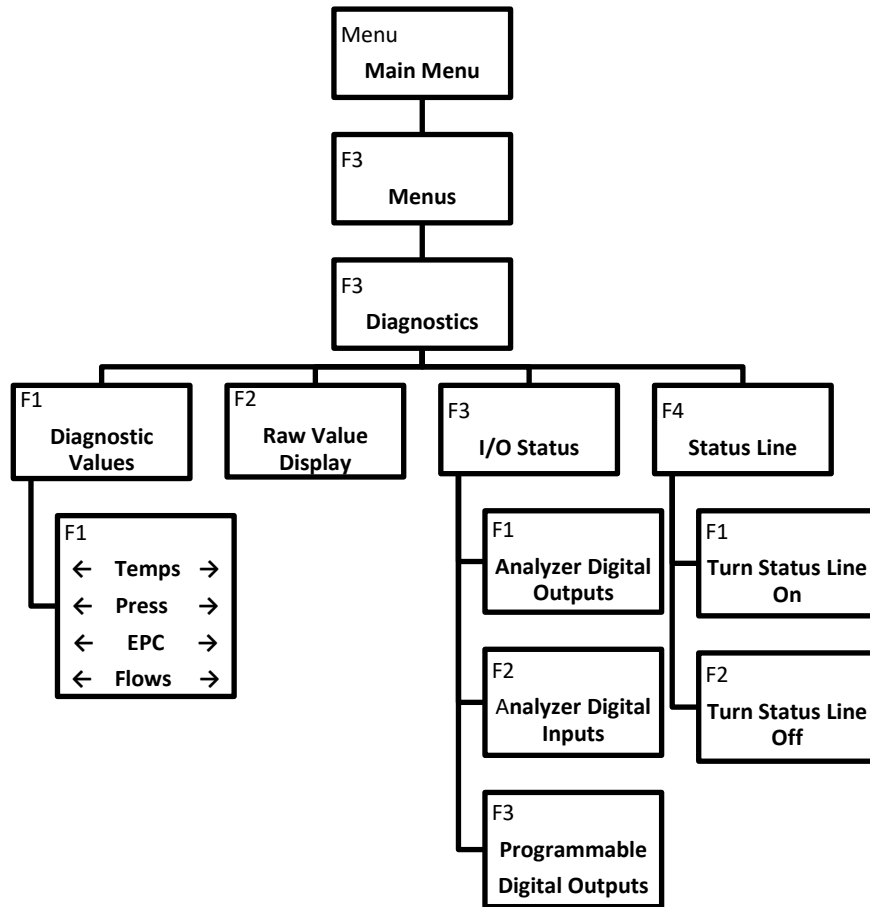

Setup

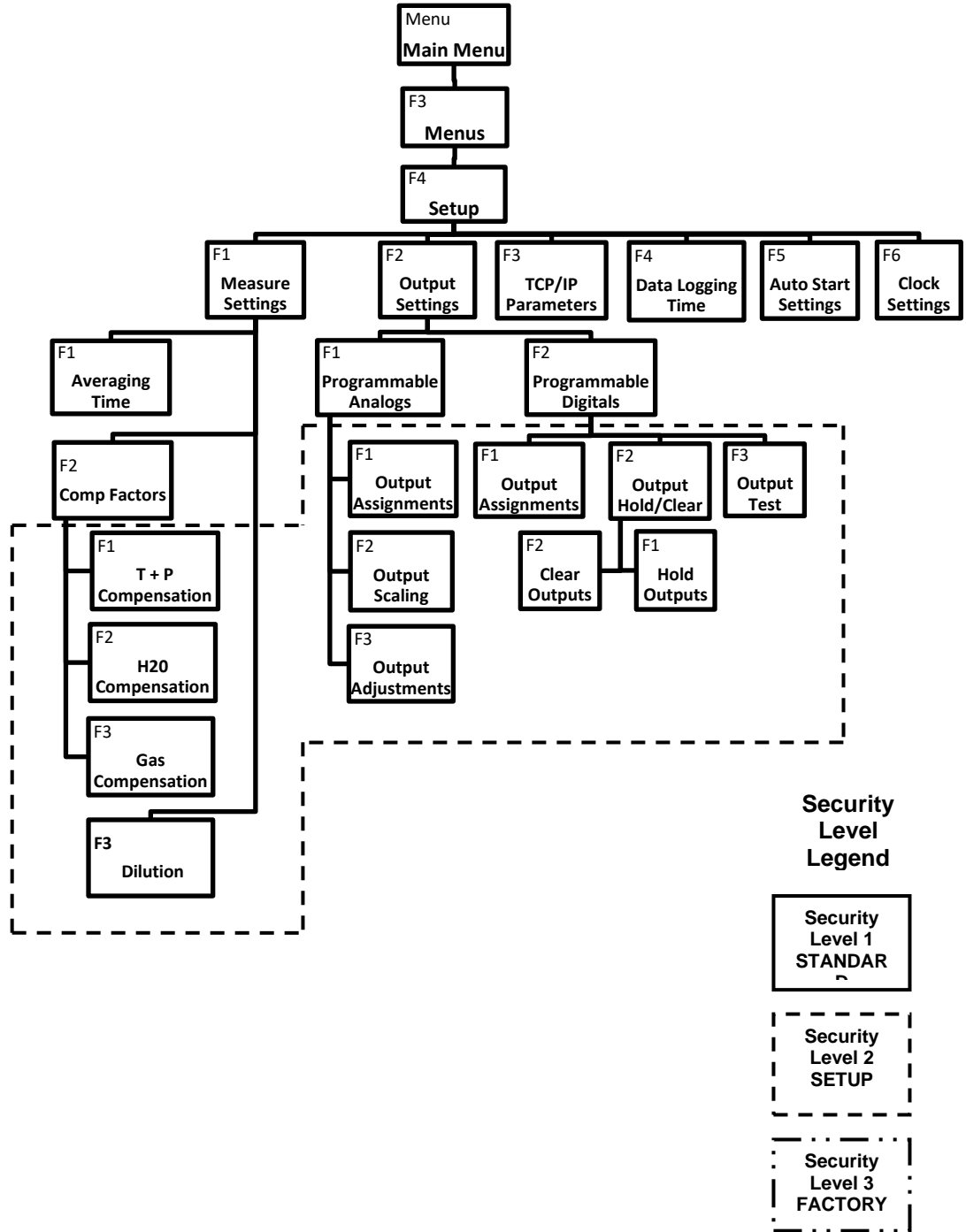

Alarms

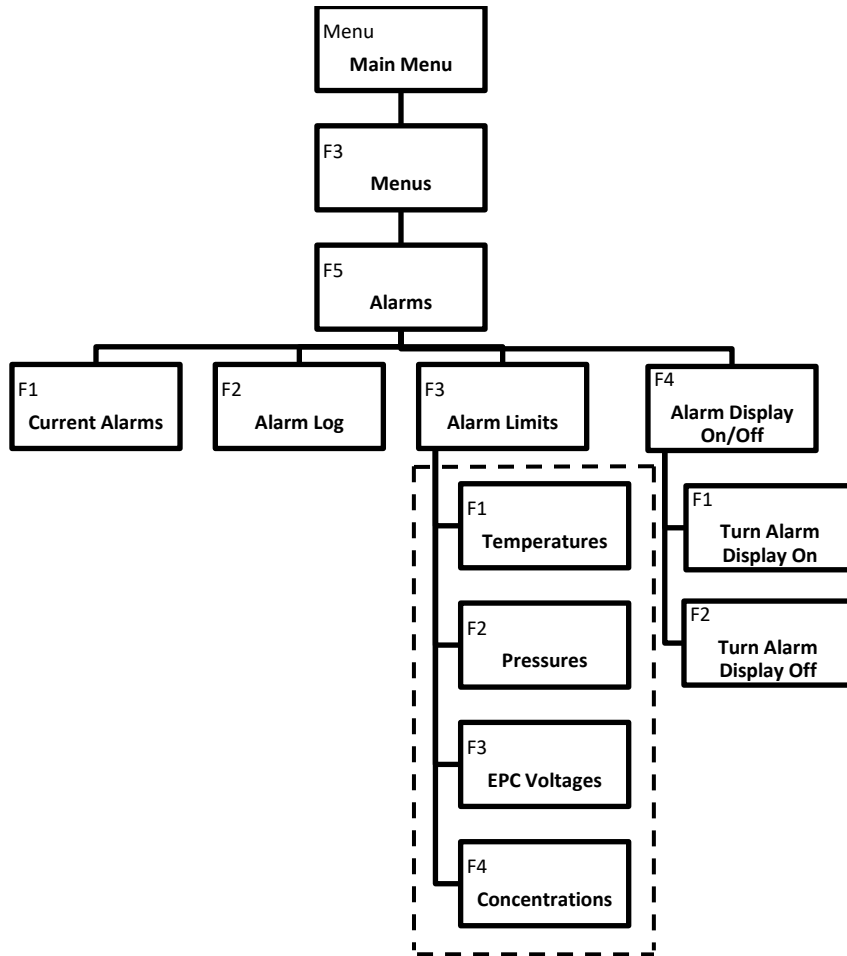

Security Level Legend

Security Level 1
STANDARD

Security Level 2
SETUP

Security Level 3
FACTORY

Service

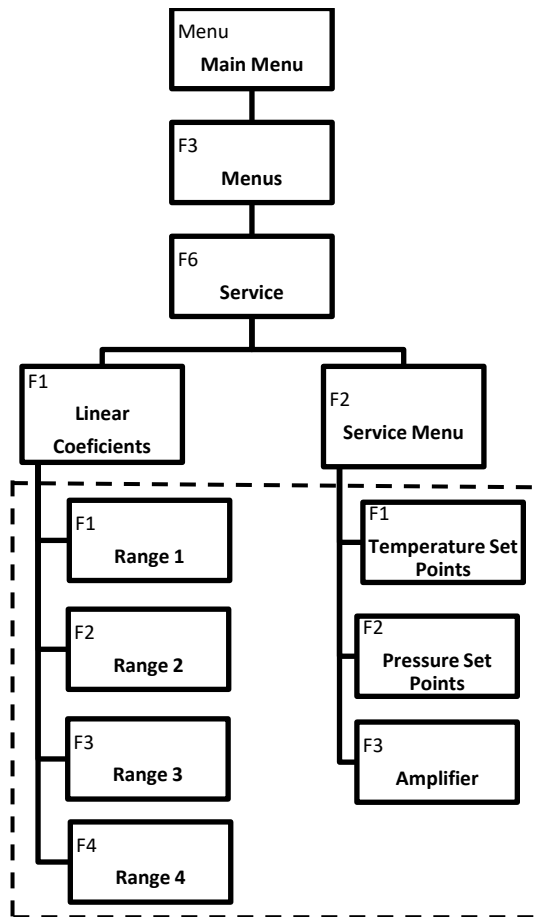

Security Level Legend

Security Level 1
STANDARD

Security Level 2
SETUP

Security Level 3
FACTORY

Security

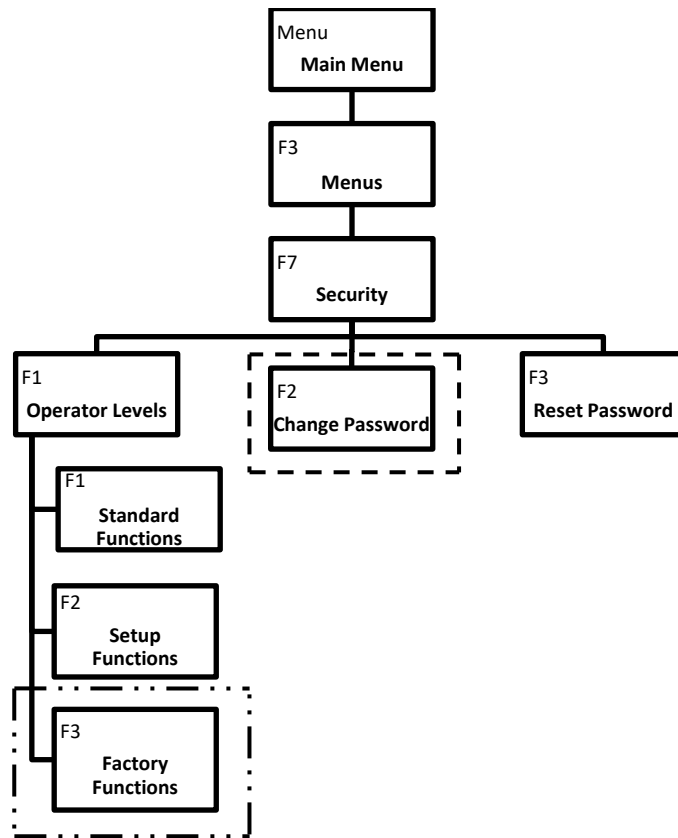

Security Level Legend

Security Level 1
STANDARD

Security Level 2
SETUP

Security Level 3
FACTORY







Main Menu



Main Menu	
F1	Measure
F2	Change Channel
F3	Menus
F4	Analyzer Info
F5	Remote/Manual... SREM
F6	Standby SMGA
	



 AK Status

The Main Menu lists the setup and maintenance functions menus for the 700LX NDIR/O₂ analyzer. All software functions of the Series 700LX NDIR/O₂ Analyzer can be reached via the menu above from the Main Menu screen.

Operation starts by pressing the Menu key  to bring up the Main Menu. Use the Arrow keys     to highlight the desired function and press  to open the screen. You can also access the desired function by pressing the corresponding function key.

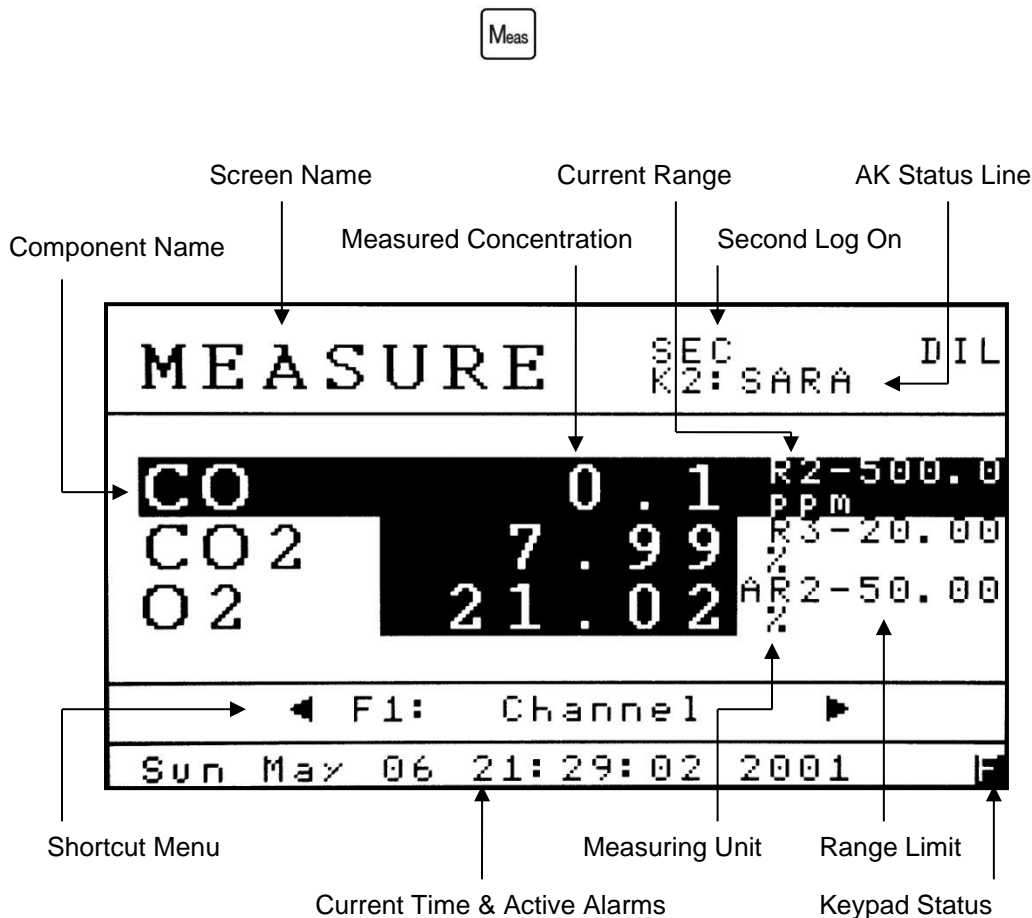
Measure Screen



The Measure Screen provides a visual of the current concentration of the gas being analyzed, along with other pertinent information. The Measure Screen is accessed by pressing the  key. To access the Measure Screen from the Main Menu, press .

Please review the descriptions below (corresponding with the callouts on the illustration above) to familiarize yourself with the Measure Screen.

Screen Name: The name of the active screen the Analyzer is in; in this case the Measure screen.

Second Log On: SEC appears when the Second log is enabled. See [Data Logging Time](#).

AK Status Line: When the AK Status line is enabled, it will scroll through the analyzer's present state using AK Protocol. See [AK Protocol](#).

Component Name: Indicates the name of the gasses being measured.

Measured Concentration: Indicates the current measured gas concentrations.

Current Range: The range currently being used by the analyzer. Auto Range is indicated by an A in front of the range number.

Range Limit: The analyzer's full-scale value of the range currently in use.

Current Time/Active Alarms: Scrolls between Time and Date and any active alarms.

Keypad Status: Indicates how the keypad input is currently being used. F is for functions, N is for numeric input.

DIL: Indicates dilution software has been factory enabled.



Up and down arrows are used to change the analyzer's current range.

Shortcut Menu: Scrollable list of shortcut functions available from the Measurement screen. See the shortcuts below:



Left or right arrows are used to scroll through the shortcut menu.



Change Channel

Allows the operator to change which component the menus will apply to.



Raw Values

An advanced diagnostic tool used for troubleshooting.

F3₃ Diags

Diagnostic Values is used to view Temperatures, Pressures, EPC Percent Full Scale voltages and Flows.

F4₄ Auto Range

Allows operators to turn Auto Range On or Off.

F5₅ Manual Cal

This is a shortcut that takes the operator to the Manual Calibration menu.

F6₆ Menus

The Menus screen is the starting point for advanced setup and functions.

F7₇ Standby

When the analyzer is in Standby mode, it closes all valves and turns off the analyzer's optional sample pump.

F8₈ Range Limits

This screen allows operators to customize the analyzer's ranges.

F9₉ Span Conc

Operators can change Span gas concentrations for multiple ranges.

F10₀ Comp Factors

This is a shortcut for operators to view or change CAI factory temperature, pressure, H₂O and gas compensation factors.

Change Channel

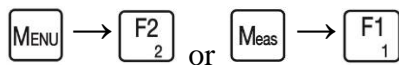

Current Status

Channel...	02
F1 CO	
F2 CO2	
F3 O2	

The Change Channel menu is used to select a component when using menus with analyzers that have multiple channels. The Change Channel menu is accessed by

pressing the **F2₂** key on the Main Menu.

Press **F1₁** to set control of Channel 1.

Press **F2₂** to set control of Channel 2.

Press **F3₃** to set control of Channel 3.

Analyzer Info

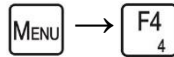

Analyzer Info 192.168.002.233	
Model	703
S/N	1608055
Sample Pres	2-10 PSI
Software Version	
3MAIN	7.667
3USER	7.766
OSMSR	63.024

The Analyzer Info screen contains the basic identity of your 700LX NDIR/O₂

Analyzer. The Analyzer Info screen is accessed by pressing the  key on the Main Menu.

This screen includes the Model and Serial Number of your analyzer (for easy identification if you are discussing your analyzer with CAI), factory settings for sample pressure and air pressure, and the software versions being used. The analyzer's current IP address appears in the upper-right corner of the screen.

Remote/Manual

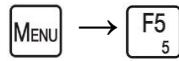

Remote/Manual	SREM
F1 Manual	
F2 Remote	



The Remote/Manual menu gives the operator the ability to control the instrument manually using the keypad or via a remote computer. The Remote/Manual menu is accessed by pressing the  key on the Main Menu. The current setting (Remote Mode) is displayed in the upper right-hand corner of the screen. **Example: SREM.**

The analyzer can be controlled remotely via:

- TCP/IP AK or Modbus
- RS-232 AK Protocol
- Digital inputs (contact closure) located on the rear of the analyzer.

AK Protocol works with both TCP/IP and Serial RS-232. Modbus only works with TCP/IP.

Standby

MENU →  or Meas → 

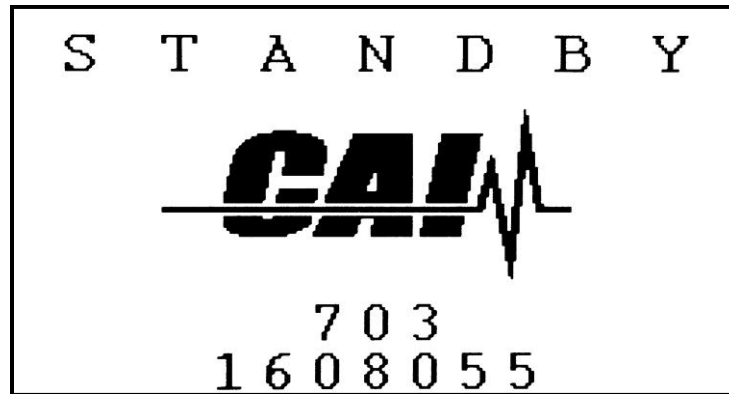

When the analyzer is in Standby Mode, the pump is turned off and the solenoid valves are closed. The CAI logo is displayed along with the Serial Number. Standby

Mode is accessed by pressing the  key from the Main Menu.

Menus





Menus
F1 Calibration
F2 Range Setup
F3 Diagnostics
F4 Setup
F5 Alarms
F6 Service
F7 Security

The Menu screen provides access to most instrument features, including

Calibration, Setup and Diagnostics. From the Main Menu press  to bring up the Menu screen.

Press  to access the Calibration menus.

Press  to access the Range Setup menu.

Press  to access the Diagnostics menus.

Press  to access the Setup menus.

Press  to access the Alarms menu.

Press  to access the Service menu.

Press  to access the Security menu.

Calibration







Calibration
F1 Manual Calibration
F2 Automated Calibration
F3 Cal Gas Concentrations
F4 Calibration Setup
F5 Calibration Factors
F6 Reset Factory Settings

The 700LX NDIR / O₂ Analyzer requires initial calibration with zero and span calibration standards before operation. These calibrations can be performed manually or initiated automatically. From the Menus screen press  to access the Calibration menu. The Calibration menu includes important features including basic setup for both manual and automated calibration.

Preparing the Analyzer for Calibration

NOTE: If you are changing the analyzer's factory settings, Calibration Setup must be completed prior to your initial calibrations.

From the Calibration menu press  to access the Calibration Setup, or you can use this menu path to access the [Calibration Setup](#) menu:  →  →  → .

If you are not making changes to the factory settings, proceed to Manual Calibration.

Manual Calibration

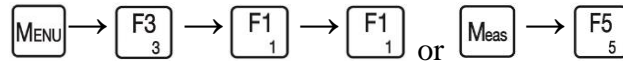

Manual Calibration
F1 zero
F2 Span

Whether you are calibrating a single range or multiple ranges, each range requires its own complete zero and span calibration. If you are calibrating multiple ranges during one session, the zero calibrations can all be performed before any of the span calibrations, as long as they are within the same relatively short time period. If multiple ranges are used, the calibrations are typically done in ascending order of range. Anytime a zero calibration is performed, a span calibration or check should be done afterward. The Manual Calibration menu is accessed by pressing  from the Calibration menu.

Press  to access the Manual Zero Calibration screen.

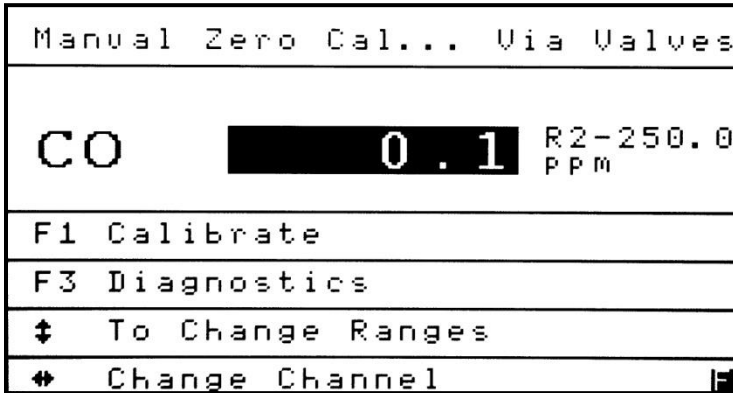

Press  to access the Manual Span Calibration screen.

Zero





A Zero calibration should be performed before a span calibration. From the Manual Calibration menu press  to access the Manual Zero Calibration screen.



If the analyzer is equipped with multiple channels, make sure you are calibrating the right component (CO shown above). If this is not the component you want to calibrate, use the

Right/Left arrow   to change the channel to the desired component.

Make sure the analyzer is in the range you wish to calibrate. Use the Up/Down arrows

  to go to the desired range. The screen illustration above shows the range (R2) next to the maximum range limit (250 ppm).

In the upper-right corner of the screen, you will see a status line that indicates how the calibration gas is being introduced into the analyzer. In this case, Cal Via valves is displayed. The other option is Cal via Pump. See [Calibration Setup](#) for details.

Introduce zero gas into the rear of the analyzer. Press  to go to the [Diagnostic Values](#) screen to view the current diagnostic values. Check the temperatures and flows to be sure they are within their limits. If all diagnostic values are within their limits, press the  button to return to the Manual Zero Calibration screen.

When the concentration value has stabilized, press  to set the zero calibration. The zero portion of the calibration should now be complete.

If the calibration was successful, the screen will say *****Saved Current***** above the concentration value.

Manual Zero Cal... Via Valves		
Saved Current		
CO	0.0	R2-250.0 PPM
F1 Calibrate		
F3 Diagnostics		
↓ To Change Ranges		
* Change Channel		

Example of a successful calibration.

If the calibration was unsuccessful, the screen will say Outside Deviation Limits.

Manual Zero Cal... Via Valves		
Outside Deviation Limits		
CO	446.5	R3-500.0 PPM
F1 Calibrate		
F3 Diagnostics		
⚡ To Change Ranges		
⚡ Change Channel		

Example of an unsuccessful calibration.

If the zero calibration is unsuccessful, check the following:

1. Make sure the correct gas was introduced into the analyzer.
2. Verify the [Diagnostic Values](#) while flowing zero and span gasses.
3. Check Zero Gas Deviations under [Manual Deviations](#):

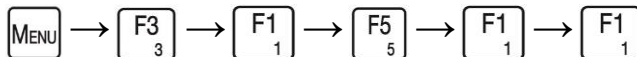

4. Check [Maximum Calibration Error](#) under Calibration Setup:

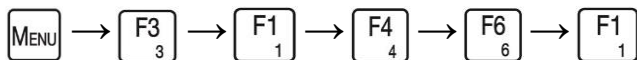

After a successful Manual Zero Calibration, press the  button to return to the Manual Calibration menu. The analyzer is now ready for a span calibration or check.

Span

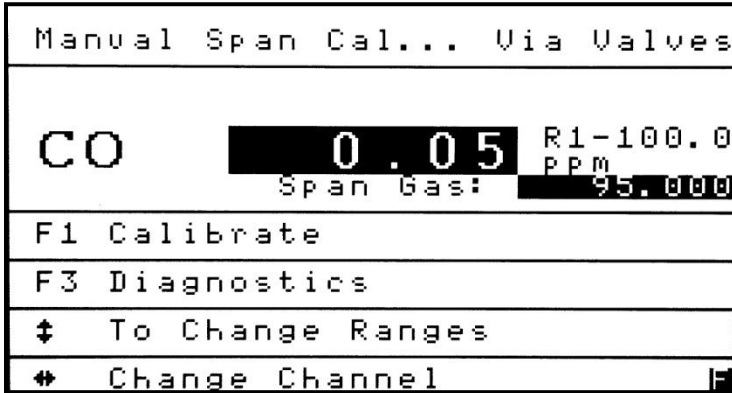

A span calibration should be performed after a successful zero calibration. From the Manual Calibration menu press to access the Manual Span Calibration screen.

Make sure the highlighted span gas value (see above) matches the value on the certificate for the span calibration gas being supplied to the analyzer. If the span gas concentration does not agree with the value on the certificate, press and change the concentration to match it. Press again to close the span gas concentration field.

Make sure the analyzer is in the range you wish to calibrate. Use the Up/Down arrows to go to the desired range. The illustration shows the range (R1) next to the maximum range limit (100 ppm).

Introduce span gas into the rear of the analyzer. Press to go to the [Diagnostic Values](#) screen to view the current diagnostic values. Check the temperatures and pressures to be sure they are within their limits. If all diagnostic values are within their limits, press the button to return to the Manual Span Calibration screen.

When the concentration number has stabilized, press  to set the span calibration. The calibration should now be complete.

If the span calibration was successful, the screen will say *****Saved Current*****. If the calibration was unsuccessful, the screen will say **Outside Deviation Limits**. See the [Manual Zero Calibration](#) section for examples of screens showing successful and unsuccessful calibrations.

If the span calibration is unsuccessful, check the following:

1. Make sure the correct gas was introduced into the analyzer.
2. Verify the [Diagnostic Values](#) while flowing gas.
3. Check Span Gas Deviations under [Manual Deviations](#):

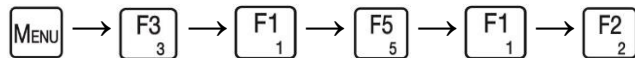

4. Check [Maximum Calibration Error](#) under Calibration Setup:

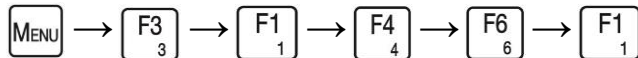

After a successful Manual Zero and Span Calibration, the analyzer is ready for use.

Automated Calibration

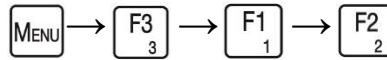

Automated Calibration	
F1	Initiate Sequenced Cal
F2	Initiate Sequenced Check
↔	Change Channel... CO2

An automated calibration is a timed zero calibration immediately followed by a timed span calibration. The Automated Calibration menu offers two choices: Sequenced Calibration and Sequenced Check of the existing calibration.

The Automated Calibration menu is accessed by pressing  from the Calibration menu. Sequenced means that the flow times of both zero and span gases are controlled using a timer. See [AutoCal Timing](#) located in the Calibration Setup menu.

NOTES:

- An automated calibration should not be attempted before manual zero and span calibrations have been successfully performed.
- If a manually initiated sequenced calibration or sequenced calibration check is selected, it will apply only to the range that is currently in use. (Each additional range must be calibrated separately). This also applies if the analyzer is in auto range.

- This automated calibration is triggered manually and **not** by the analyzer's clock or via remote signal. A fully automated sequenced calibration can be preset to include the desired interval for recurring analyzer-initiated calibrations. This requires additional setup. Automatic calibration of multiple ranges is also possible. See [Calibration Setup](#).
- If a sequenced calibration was unintentionally started, pressing the  button before the Zero step is completed will cancel the calibration.

Initiate Sequenced Cal

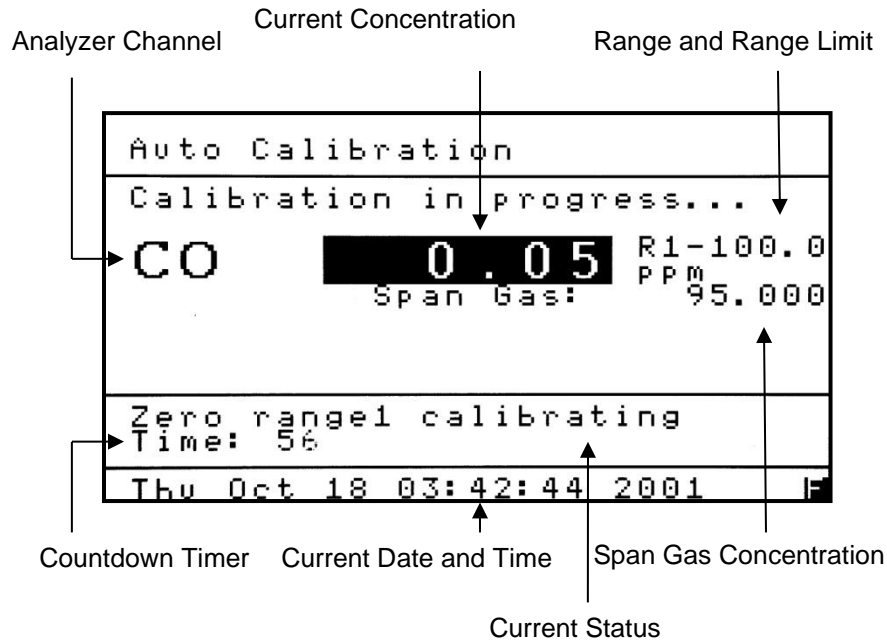

Because of timing requirements, sequenced calibrations are generally used only when the analyzer is controlling the flow of zero and span gases into the analyzer.

To initiate a sequenced calibration, press  from the Automated Calibration menu.

A sequenced calibration has seven steps. The Current Status of each step is shown just below the expected gas concentration (in this case, it is Purging with Sample). Each step uses a countdown timer set up in [AutoCal Timing](#), located in the Calibration Setup menu. The sequence (with the current range indicated) is as follows:

1. **Zero Range 1 Purging** – Allows time for the zero gas to flush out any residual gases that may still be present in the detection path.
2. **Zero Range 1 Calibrating** – The calculated zero is set as the new offset value, as long as it is within the [Maximum Calibration Error](#) limits.
3. **Zero Range 1 Verifying** – The analyzer verifies that the calibrated zero value has not deviated outside the operator-set allowable [Maximum Verifying Error](#).

4. **Span Range 1 Purging** – Allows time for the span gas to flush out any residual zero gas that may still be present in the detection path.
5. **Span Range 1 Calibrating** – The calculated span is set as the new gain value, as long as it is within the [Maximum Calibration Error](#) limits.
6. **Span Range 1 Verifying** – The analyzer verifies that the calibrated span value has not deviated outside the operator-set allowable [Maximum Verifying Error](#).
7. **Purging With Sample** – Introduces sample gas back into the analyzer and clears out any remaining gases so the current measurements will not be affected by any residual calibration gases.

After these steps, if the calibration is successful, the display will briefly indicate **Calibration Finished** in place of Calibration in Progress at the top of the screen. After a successful calibration is completed, the analyzer will return to the Measure Screen.

If the calibration is unsuccessful, the display will briefly indicate **Could Not Calibrate** in the Current Status line. At the same time, you will be alerted to whether an error occurred in the zero or span portion of the calibration (for example, Span Gas Deviation Error!). The analyzer will then return to the Measure Screen and will revert to the last successful calibration values. A calibration error is set and will remain until cleared by a successful calibration.

To view the verifying zero or span deviations, go to the [AutoCal Deviations](#) menu under Calibration Factors. To view or change the maximum allowable calibration tolerances, see [Deviation Limits](#).

Initiate Sequenced Check

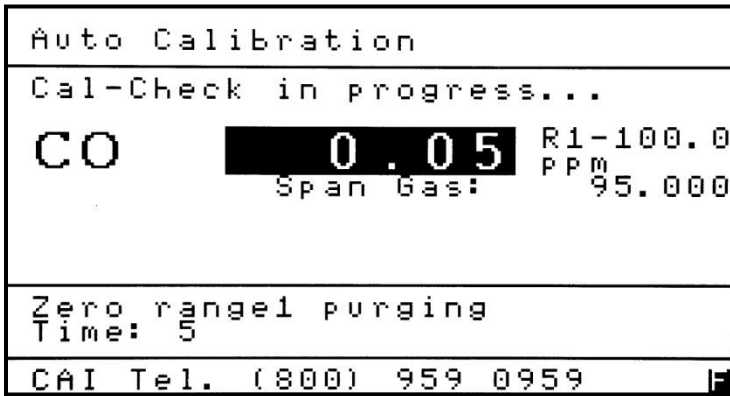

Initiate Sequenced Check is a useful tool for setting up Auto Calibration. From the Auto Calibration Menu screen, pressing  initiates a sequenced calibration **check**. Rather than initiating a calibration, it checks the validity of your most current calibration.

A sequenced calibration check performs all of the steps of a sequenced calibration with the exception of the zero and span **calibrations**. It does not set new offsets, gains or any alarms.

Cal Gas Concentrations

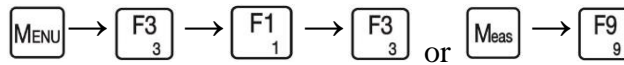



Cal Gas Concentrations		
CO	Gas Value	Range
Range 1	95.000	100.00
Range 2	235.000	250.00
Range 3	450.000	500.00
Range 4	950.000	1000.00
↔ Change Channel...		CO
F1 SAVE		



The Cal Gas Concentrations screen allows operators to change calibration gas values for multiple ranges on one screen. To access the Cal Gas Concentrations screen

(shown above) press $\boxed{\text{F3}_3}$ from the Calibration Menu.

The Cal Gas Concentrations screen displays the component, range identification, changeable span gas value and the full-scale value set for that range.

If the analyzer is equipped with multiple channels, make sure you are calibrating the right component (CO shown above). If this is not the component you want to calibrate, use the

Right/Left arrow   to change the channel to the desired component.

Using the Up/Down arrows   move the highlighted field to the span gas value you wish to change (for example, 95.00 above). Press $\boxed{\text{ENTER}}$ to open the span gas value field and change the value to match the span gas being supplied to the analyzer. Press $\boxed{\text{ENTER}}$ again to close the span gas value field. Press $\boxed{\text{F1}_1}$ to save the changes.

Calibration Setup

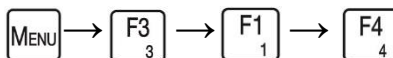

Calibration Setup	
F1	AutoCal Schedule
F2	AutoCal Parameters
F3	Cal Pump/Valves... Valves
F4	Auto Cal/Check... Check
F5	AutoCal Timing
F6	Deviation Limits
F7	Analog Hold On Cal... On

The Calibration Setup menu provides all the parameters necessary for completing a successful calibration. To access the Calibration Setup menu, select  from the Calibration menu.





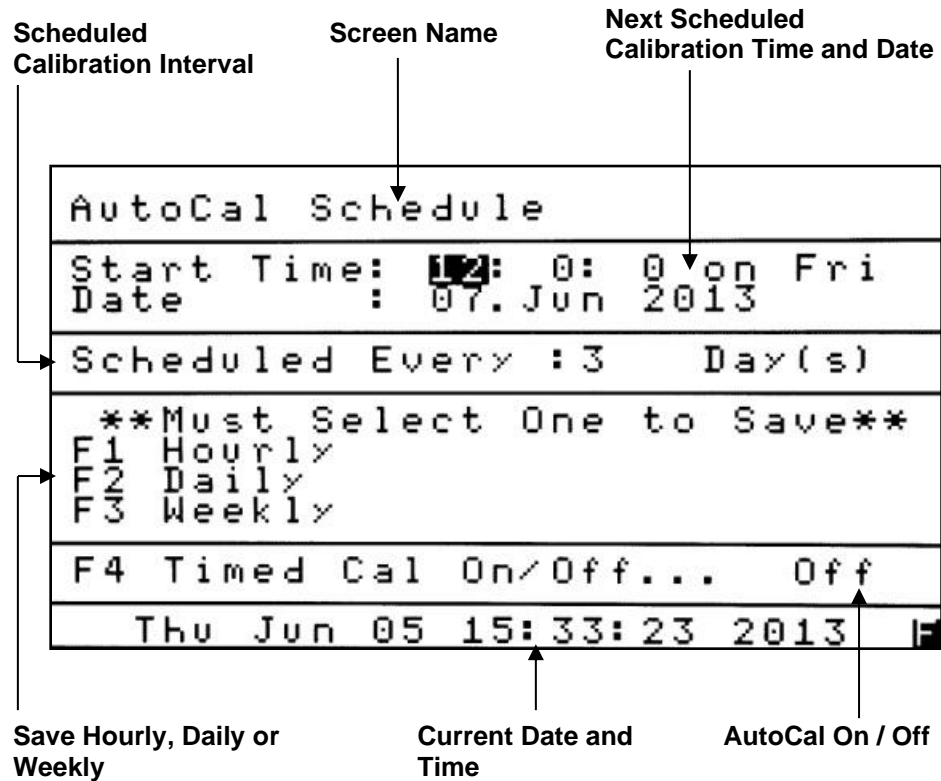

All parameters on the Calibration Setup menu apply to Automated Calibration. The following also apply to Manual Calibration: Cal Pump/Valves, Auto Cal/Check, Deviation Limits and Analog Hold on Cal. All settings should be verified for correct information before a manual or automated calibration is attempted.



Please note that the Calibration Setup menu shows the current settings on the right side of the screen after the ellipsis (...). Example: **Cal Pump/Valves . . . Valves.**





Auto Calibration Schedule



The Auto Calibration Schedule screen allows the operator to run automated calibrations using the analyzer's internal clock. In addition to the Start Time and Date, the Scheduled Calibration interval (in the example, scheduled every 3 days) can be changed by the operator. The Auto Calibrations screen is accessed by pressing  from the Calibration Setup menu.

Use the arrow buttons     to move the highlight to changeable fields (in the example, Start Time: **12**). Press  to open the field and change the value. Press  again to close the field after you have made your changes.

After all the changes have been made, you **must** choose one of the following:  (Hourly),  (Daily) or  (Weekly) to save your changes. **If this is not done**, the selected changes will not be made and the analyzer will revert to the previous settings.

To change Timed Auto Calibration to on or off, press  (Timed Cal On/Off). A submenu will open with two choices. Press  to turn Timed Cal On, or press  to turn Timed Cal Off. Selecting  or  will bring you back to the AutoCal Schedule screen. The current setting is shown on the right side of the menu after the ellipsis (. . .). In the example, **Timed Cal On/Off . . . Off**.





Auto Calibration Parameters









AutoCal Parameters	
Select 0 for all ranges	
Range [0 - 4]...	1
Channel	All
Cal Gases...	All
F1 SAVE	





Auto Calibration Parameters allows the operator to select the range, mode and choose between Zero and All calibration gases (both zero and span). To access the

AutoCal Parameters screen, press  from the Calibration Setup menu.

To navigate between parameters, use the up or down arrow   to move the highlight to the field you intend to change. Press  to open the field and change the parameter. Press  again to close the field after you have made your change.

The first changeable parameter is the Range to be calibrated. Press  to open the field and change the range. Then select a range (from 1 – 4) for calibration. To select all ranges, press 0. Press  to close the field.

The second parameter the operator can change is the Channel. The 700LX NDIR/O2 Analyzer can calibrate a single channel or all channels. Press  to open the field and select the channel using the up/down arrows  . Press  to close the field.

Calibration Gases gives you a choice of calibrating with Zero gas only or All calibration gases (zero and span gases). Press  to open the field and change the parameter using the up/down arrows  . Press  to close the field.

Press  to save your settings. Once your changes have been saved, the analyzer will return you to the Calibration Setup menu.

Calibration Via Pump/Valves



Cal via Pump/Valves	Valves
F1 Cal via Pump	
F2 Cal via Valves	

The use of Cal via Pump/Valves depends upon how calibration gases are being introduced into the analyzer – via a sample pump or via internal valves (if equipped with the internal valve option). The existing setting (Valves in the example) is shown at the top right of the menu. To access the Cal via Pump/Valves menu, press from the Calibration Setup menu.

Press (Cal via Pump) to keep the analyzer’s internal sample pump on and keep the valves closed during calibration. You will return to the Calibration Setup Menu. Please note that the Calibration Setup menu will display the current settings on the right side of the screen after the ellipsis (...). **Example: Cal Pump/Valves . . . Pump.**

NOTE: If the analyzer is equipped with a pump, to prevent damage to the pump do not pressurize the sample inlet.

Press (Cal via Valves) to activate the appropriate calibration valve and keep the internal sample pump turned off during calibration. Keeping the sample pump turned off while the valves are activated will prevent sample from being mixed with calibration gas. You will return to the Calibration Setup Menu. Please note that the Calibration Setup menu shows the current settings on the right side of the screen after the ellipsis (...). **Example: Cal Pump/Valves . . . Valves.**

Auto Calibration/Check

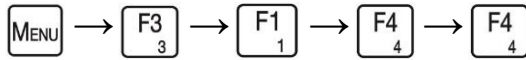

Set Auto Cal/Check	Check
F1 Set Auto Cal to Calibrate	
F2 Set Auto Cal to Check	

Auto Calibration/Check lets the operator select whether the analyzer actually calibrates, or performs a check of the calibration. To access the Auto Cal/Check

menu, press  from the Calibration Setup menu. The current setting is shown on the upper-right corner of the screen.

Press  to set the analyzer parameter to Calibrate. This setting will be saved and the analyzer will return to the Calibration Setup menu. The Calibration Setup menu shows the current setting on the right side of the screen after the ellipsis (. . .).

Example: Auto Cal/Check . . . Cal.

Press  to set the analyzer parameter to Check. The setting will be saved and the analyzer will return to the Calibration Setup menu. The Calibration Setup menu shows the current setting on the right side of the screen after the ellipsis (. . .).

Example: Auto Cal/Check . . . Check.



Auto Calibration Timing







AutoCal Timing [sec]	CO
Purge Before...	10
Calibrating	10
Verifying...	10
Purge After...	10
Total	70
✦ Change Channel...	CO
F1 SAVE	

Auto Calibration Timing determines the length of time it takes the analyzer to perform the Zero and Span cycles during a sequenced auto calibration. To access the

AutoCal Timing screen, press  from the Calibration Setup menu. All values on the screen are expressed in seconds.

Each Channel will have its own set of values. Use the left or right arrow keys   to select the desired component.

To navigate between parameters, use the up or down arrow   to move the highlight to the field you intend to change. Press  to open the field and change the value (seconds). Press  again to close the field after you have made your change.

A sequenced auto calibration consists of two cycles: Zero and Span. In both cases, the cycle duration is equal to the sum of the Purge Before, Calibration and Verification times. The Total Auto Calibration time is equal to the sum of the Zero and Span cycle times plus the Purge After time. See the example above.

- 1. Purge Before:** the operator can set the amount of time necessary to flush the analyzer with calibration gases. This will ensure that there are no other gases remaining in the analyzer during the calibration process.
- 2. Calibrating Time:** during this 10-second time, the analyzer will calculate new offset and gain factors. The calibrating time is factory-set at 10 seconds and cannot be changed by the operator.
- 3. Verifying Time:** during this time the measured value is checked to make sure it does not deviate outside the upper or lower limit specified by the [Maximum Verifying Error](#). The verifying time is typically set for 10 seconds.
- 4. Purge After:** the operator can set the time needed to flush any remaining calibration gases out of the analyzer before the In Cal Status is released and the measurement status is set. Purge after starts after the last component has finished verifying.

After the Auto Calibration Timing has been set, press  to save the changes.

Deviation Limits



Deviation Limits
F1 Maximum Calibration Error
F2 Maximum Verifying Error

Deviation Limits are used by the operator to define the maximum acceptable error limits of the zero and span gases for both manual and sequenced calibration. To

access the Deviation Limits menu, press  from the Calibration Setup menu.

Press  to set or view the Maximum Calibration Error Limits.





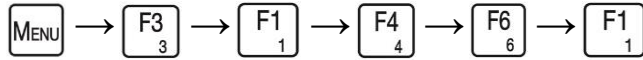

Press  to set or view the Maximum Verifying Error Limits.

Maximum Calibration Error



Maximum Calibration Error [%]		
CO	Absolute	Relative
Range 1	70.00	70.00
Range 2	70.00	70.00
Range 3	70.00	70.00
Range 4	70.00	70.00
↔ Change Channel...	CO	
F1 SAVE		

Maximum Calibration Error is used by the operator to define the maximum acceptable tolerances for **Absolute and Relative deviations**. Each range has its own set of Absolute and Relative tolerances. The deviations must be inside these tolerances for the analyzer to accept a calibration. To access the Maximum Calibration Error screen, press  from the Deviation Limits menu.

Use the left or right arrow keys   to select the component you wish to view or change. To navigate between fields, use the up or down arrow keys   to move to the highlight to the field you intend to change. Press  to open the field to change the allowable tolerance in %. Press  again to close the field. Press  to save your changes.

Absolute Deviation is used to compare the factory-set calibration to the current calibration.





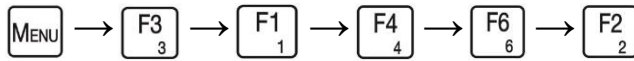

Relative Deviation compares the current calibration to the previous calibration.

Maximum Verifying Error



Maximum Verifying Error [%]	
CO	Allowable
Range 1	1.00
Range 2	1.00
Range 3	1.00
Range 4	1.00
↔ Change Channel...	CO
F1 SAVE	

Maximum Verifying Error is the allowable tolerance during the Verifying step of sequenced calibration. To access the Maximum Verifying Error screen, press  from the Deviation Limits menu.

Use the left or right arrow keys   to select the component you wish to view or change. To set the allowable tolerances for different ranges, use the up or down arrow   to move the highlight to the field you intend to change. Press  to open the field to change the value in %. Press  again to close the field. Press  to save your changes.

Analog Hold on Cal



Analog Hold On Cal	Off
F1	Analog Hold On
F2	Analog Hold Off

Analog Hold on Cal will hold the analog outputs to the last measured value during calibration. If Analog Hold on Cal is Off the analog outputs will be live. The existing setting (**Off**) is shown at the top right of the menu. To access the Analog Hold on Cal menu, press  from the Calibration Setup menu.

From the Analog Hold On Cal menu, press  to turn Analog Hold On, which will hold the analog outputs at the last measured value. You will return to the Calibration Setup menu. The Calibration Setup menu shows the current setting at the bottom-right corner of the screen after the ellipsis (. . .).

Example: Analog Hold on Cal . . . On.

From the Analog Hold On Cal menu, press  to turn Analog Hold Off. You will return to Calibration Setup menu. The Calibration Setup menu shows the current setting at the bottom-right corner of the screen after the ellipsis (. . .).

Example: Analog Hold on Cal . . . Off.

Calibration Factors

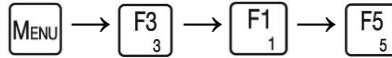

Calibration Factors
F1 Manual Deviations
F2 Auto Cal Deviations
F3 Offset/Gain Factors

Calibration Factors allow the operator to track and view changes from the factory

and previous calibrations. To access the Calibration Factors menu, press  from the Calibration menu.

Press  to view the Manual Calibration Deviations menu.

Press  to view the Auto Calibration Deviations menu.

Press  to access the Offset and Gain Factors screen.

Manual Deviations



Manual Deviations
F1 Zero Gas Deviations
F2 Span Gas Deviations
F

The Manual Deviations menu allows the operator to view the Zero and Span

Deviations from manual calibrations. Press  from the Calibration Factors menu to access the Manual Deviations menu.

Press  to view Zero Gas deviations.

Press  to view Span Gas deviations.

Zero Gas Deviations

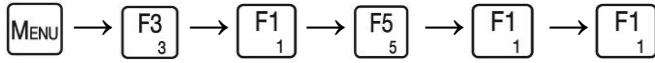

Zero Gas Deviations [%]		
CO	Abs	Rel
Range 1	0.00	0.00
Range 2	0.00	0.00
Range 3	0.00	0.00
Range 4	0.00	0.00
* Change Channel...		CO

Press  from the Manual Deviations menu to view the Zero Gas Deviations screen.

Use the left or right arrow keys   to select the component you wish to view.

Absolute Zero Gas Deviation is the zero gas content calculated by the factory polynomial related to the calibrated range limit.

Relative Zero Gas Deviation is the current deviation minus the deviation of the previous calibration related to the calibrated range limit.

Span Gas Deviations



Span Gas Deviations [%]		
CO	Abs	Rel
Range 1	0.00	0.00
Range 2	0.00	0.00
Range 3	0.00	0.00
Range 4	0.00	0.00
↔ Change Channel...		CO

Press  from the Manual Deviations menu to view the Span Gas Deviations screen.

Use the left or right arrow keys   to select the component you wish to view.

Absolute Span Gas Deviation is span gas bottle value minus span gas value calculated by the factory polynomial related to the calibrated range limit.

Relative Span Gas Deviation is the current deviation minus the deviation of the previous calibration.

Auto Cal Deviations



Auto Cal Deviations
F1 Verifying Zero Devs
F2 Verifying Span Devs

The Auto Calibration Deviations menu gives the operator a choice of viewing either zero or span verifying deviations. The verifying deviations are taken during the verifying stage of sequenced and auto calibrations. Press  from the Calibration Factors menu to access the Auto Cal Deviations menu.

Press  to view the Verifying Zero Deviations screen.

Press  to view the Verifying Span Deviations screen.

Zero Gas Deviations Verifying

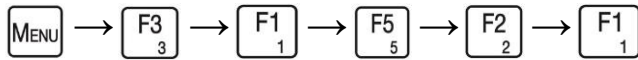

Zero Gas Deviation Verifying			
CO	Meas	Var	%FS
R1	0.0	0.00	0.00
R2	0.0	0.00	0.00
R3	0.0	0.00	0.00
R4	0.0	0.00	0.00
↔ Change Channel...			CO

Press  from the Auto Cal Deviations menu to view the Verifying Zero Deviations screen.

Use the left or right arrow keys   to select the component you wish to view.

Measured Value is the averaged concentration during the Verifying Zero stage of sequenced and auto calibrations.

Variance is the difference of the measured value and zero.

% FS is the percent of full scale related to the calibrated range limit.

Span Gas Deviations Verifying

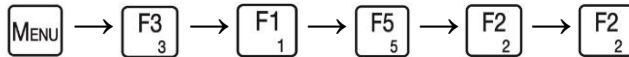

Span Gas Deviation Verifying			
CO	Meas	Var	%FS
R1	0.0	0.00	0.00
R2	0.0	0.00	0.00
R3	0.0	0.00	0.00
R4	0.0	0.00	0.00
* Change Channel...			CO

Press  from the Auto Cal Deviations menu to view the Verifying Span Deviations screen.

Use the left or right arrow keys   to select the component you wish to view.

Measured Value is the averaged concentration during the Verifying Span stage of sequenced and auto calibrations.

Variance is the difference of the measured value and span gas concentration.

% FS is the percent of full scale related to the calibrated range limit.

Offset/Gain Factors



Offset/Gain Factors		
CO	Offset	Gain
Range 1	0.00	1.00
Range 2	0.00	1.00
Range 3	0.00	1.00
Range 4	0.00	1.00
✦ Change Channel...		CO

When used in conjunction with the Manual Calibration Deviations, an increasing or decreasing change in Offset or Gain will provide insight into changes in analyzer

performance. Press  from the Calibration Factors menu to access the Offset/Gain Factors screen.

Use the left or right arrow keys   to select the component you wish to view.

Offset is the difference between factory zero and the value stored during zero calibration.

Gain is the value stored during span gas calibration using the operator-defined calibration gas.

Reset Factory Settings

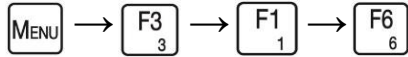

Reset Factory Settings
F1 Reset Offsets and Gains
F2 Reset Linear Coefficients





The **Reset Factory Settings** menu gives the operator a choice of resetting the **Offsets and Gains**, or both **Factory Linear Coefficients and Offsets and Gains** for all **calibrated ranges**. Resetting factory settings will not affect any other operator-changed parameters.

Press  to reset the Offsets and Gains.

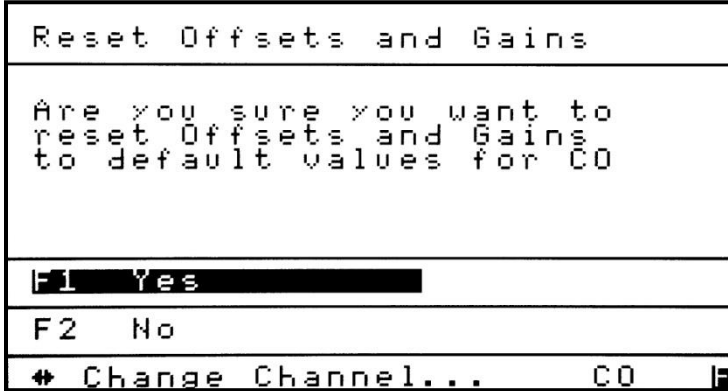
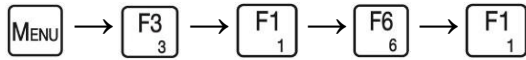
Press  to reset the Linear Coefficients, Offsets and Gains.

Reset Offsets and Gains



Pressing  from the Reset Factory Settings menu will prompt the operator to confirm resetting Offsets and Gains for all ranges of the current channel. Use the left or right arrow keys   to select the component you wish to reset. Pressing  (Yes) from this screen resets the Offset and Gain factors to factory default settings (0 and 1 respectively) and brings you to this confirmation screen:

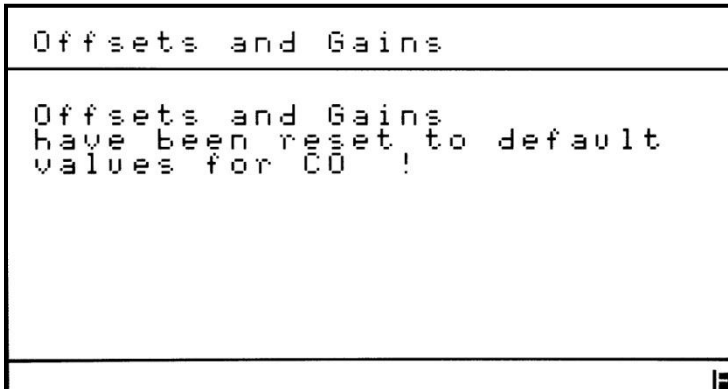



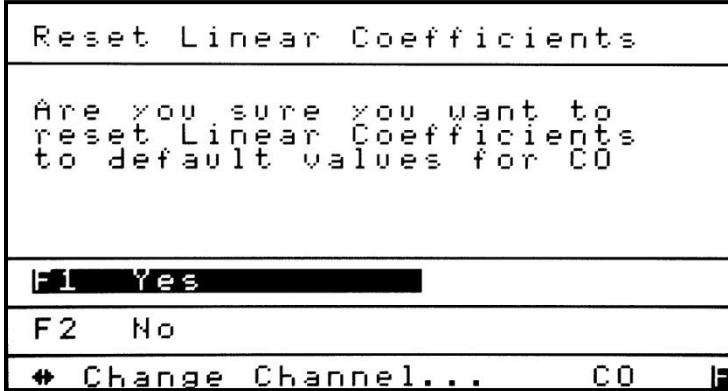

- Offset and Gain factors are created when the analyzer is zeroed and spanned.
- If the Offsets and Gains are reset, the analyzer must be zeroed and spanned again before use.
- All recorded deviations will be set to zero.

If you press  (No) from the Reset Offsets and Gains screen, the analyzer will return to the Reset Factory Settings menu without resetting the Offsets and Gains.

Reset Linear Coefficients



Pressing  from the Reset Factory Settings menu will prompt the operator to confirm resetting the Linear Coefficients for all ranges. Use the left or right arrow keys   to select the component you wish to reset. Pressing  (Yes) from this screen resets all the **Linear Coefficients, Offset and Gain Factors** to factory default settings and brings you to this confirmation screen:

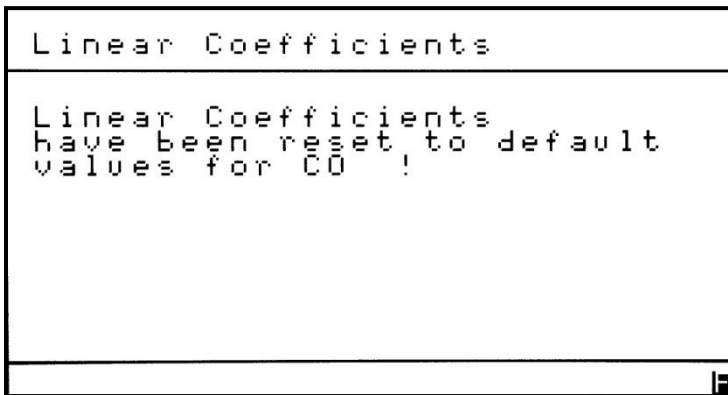

NOTE: After resetting Linear Coefficients, the analyzer must be zeroed and spanned before further use.

If you press  (No) from the Reset Linear Coefficients screen, the analyzer will return to the Reset Factory Settings menu without resetting the Linear Coefficients, Offsets and Gains Factors.

Range Setup



Range Setup
F1 Range Limits
F2 AutoRange On/Off
F3 AutoRange Switch Points

Range Setup allows the operator to change Range Limits, turn Auto Range On or Off, and change Auto Range Switch Points. From the Menus screen press  to access the Range Setup menu.

Press  to view or change Range Limits.

Press  to access the Auto Range On/Off menu. In either case, you will return to the Range Setup menu. The Range Setup menu shows the current status on the right side of the screen after the ellipsis (...). **Example: AutoRange On/Off. . . Off.**

Press  to view or change Auto Range Switch Points.

Range Limits

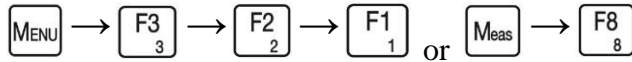

Range Limits	
Maximum Range Limit 20.000	
Range 1	2.50
Range 2	5.00
Range 3	10.00
Range 4	20.00
↔ Change Channel...	CO2
F1 SAVE	

The analyzer is factory configured with up to four physical ranges (1 - 4). The operator can change the number of ranges and range concentration up to the factory set Maximum Range Limit. From the Range Setup menu press to access the Range Limits screen.

Use the left or right arrow keys to select the component you wish to view or change. To change the Range Limits from the factory settings, use the up or down arrows to move the highlight to the field you intend to change. Press to open the field to change the value. Press again to close the field. Press to save your changes. To initiate the saved changes, press , then press and select new range.

IMPORTANT NOTES:

1. The Range Limit values must be set in ascending order.
2. The analyzer will not allow any of the range limits to exceed the Maximum Range Limit displayed on the Range Limits screen. **Example: Maximum Range Limit 20.000.**
3. To set a single range, set Range 1 to the desired value and all others to zero.

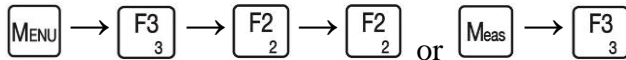

4. To set two ranges, set Range 1 to the lowest value, Range 2 to the highest value, and the others to zero.
5. If new ranges are saved, the Auto Range Switch Points will be reset to default percentages of range limits. See [Auto Range Switch Points](#).
6. If new ranges are saved, customer set linearization coefficients will be replaced with factory coefficients that correspond with the new ranges.
7. If a new range is saved all Ranges will need to have a zero and span calibration performed.

Auto Range On/Off



AutoRange	Off
F1	AutoRange On
F2	AutoRange Off
↔ Change Channel...	CO2

The Auto Range Function allows the analyzer to automatically switch up and down between ranges at predetermined concentrations. From the Range Setup menu press

F2₂ to access the Auto Range On/Off screen. The current Auto Range status appears in the upper-right corner of the screen. Use the left or right arrow keys   to select the component you wish to view or change.

Press F1₁ to turn Auto Range On. This function allows the analyzer to automatically change ranges without the presence of an operator.

Press F2₂ to turn Auto Range Off. When Auto Range is Off, the operator will need to manually change the ranges. The Range Setup menu shows the current status on the right side of the screen after the ellipsis (...). **Example: AutoRange On/Off. . . Off.**

AutoRange Switch Points

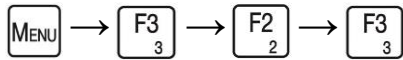

AutoRange Switch Points		
Range	Down	Up
Range 1		90.000
Range 2	81.000	225.000
Range 3	202.500	450.000
Range 4	405.000	
F1 SAVE F2 Set Default		
F3 Change Channel... CO		

Auto Range Switch Points determine when the analyzer automatically changes a range up or down when the Auto Range function is turned on. From the Range Setup

menu press to access the Auto Range Switch Points screen.

The Default Switch Points are created by the range limits. The Up Switch Point is 90% of the Range Limit. The Down Switch Point is 90% of the previous range's Up Switch

Point. Press the key to select the component you wish to view or change.

To change the Auto Range Switch Points, use the up/down arrows to move the highlight to the field you intend to change. Press to open the field to change the value in ppm. Press again to close the field. Press to save your changes. To initiate the saved changes, press , then press and select new Auto Range Switch Points.

In the example above, if the Range 1 concentration reaches 90.00 ppm, the analyzer will switch to Range 2. If the concentration for Range 2 gets as low as 81 ppm, the analyzer will switch to Range 1.

Diagnostics



Diagnostics	
F1	D agnostic Values
F2	Raw Value Display
F3	I/O Status
F4	Status Line... OFF

The Diagnostics menu allows the operator to access key troubleshooting screens including Diagnostic Values, Raw Values and digital Input / Output statuses. From

the Menus screen press  to access the Diagnostics menu.

Press  to access the Diagnostic Values screen. It allows you to check analyzer temperatures, pressures, EPC voltage percentages and flows.

Press  to access the Raw Values Display menu.

Press  to access the I/O Status menu. You can check the status (Open or Closed) of the analyzer's digital outputs and inputs.

Press  to turn On or Off the AK Status Line. The current setting is shown on the Diagnostics menu on the right side of the screen after the ellipsis (...). **Example: Status Line. . . Off.**

Diagnostic Values

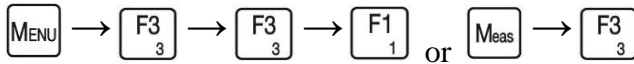



Temperatures Screen

Temperatures [°C]			
Device	Value	LoLimit	HiLimit
Case	34.99	10.00	40.00
CO	51.54	45.00	55.00
CO2	33.78	30.00	60.00
O2	49.92	45.00	55.00

Use ◀ ▶ keys to scroll
 Temps Press Volts Flows

The Diagnostic Values screens allow the operator to check analyzer temperatures, pressures, voltages and flows. These important screens are accessed by pressing  from the Diagnostics menu.

The first screen that appears is the Temperatures screen. The Temperatures screen displays the current temperature and low and high alarm limits for key analyzer components.

As indicated at the bottom of the screen, use the left and right arrow keys   to scroll to different screens. The current screen will be highlighted (Temps in the example above).

- The Temperatures, Pressures and EPC Voltage Percent screens include the current device Values and the Low and High Alarm Limits. For example, if the CO detector temperature drops lower than 45°C or exceeds 55°C an alarm will be triggered and displayed at the bottom of the [Measure Screen](#).

Pressures Screen

Pressures [psi]			
Device	Value	LoLimit	HiLimit
Baro	14.70	11.00	15.00
CO	8.00		
CO2	7.99		
O2	8.01		

Use ◀ ▶ keys to scroll
 Temps Press Volts Flows F

The Pressures screen displays current barometer and sample pressure across the flow orifice along with low and high alarm limits in PSI.

EPC Voltage Percent Screen

Voltages [%]			
Device	Value	LoLimit	HiLimit
Ext 1	0.02	0.00	10.00
Ext 2	1.04	0.00	10.00
EPC 1	49	1.00	90.00
EPC 2	47	1.00	90.00
EPC 3	42	1.00	90.00

Use ◀ ▶ keys to scroll
 Temps Press Volts Flows F

The EPC screen displays the percentage of EPC voltage being supplied to the EPC valve along with external 1 and 2 voltages. External 1 and External 2 are used by factory for gas and humidity compensation when equipped.

Flows Screen

Flows [L/m]			
Device	Value	LoLimit	HiLimit
CO	1.50	0.20	2.50
CO2	1.50	0.20	2.50
O2	0.45	0.20	0.60

Use ◀ ▶ keys to scroll
Temps Press Volts Flows F

The Flows screen displays the current flow of sample and air in L/minute. It does **not** include an alarm function because flows are calculated values based on the pressures across an orifice.

Raw Values Display

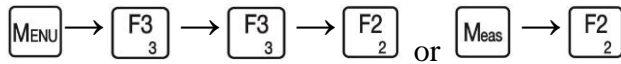

CO	Raw Values	Raw Volts
F1	Channel	0.507
F2	Alarms	Raw Conc.
F3	Diagnostics	0.13
F4	Flow Zero	Meas Conc.
F5	Flow Span	450.13
		Zero
↑	Range Up/Down	R3-500.0

The Raw Values Display screen is a diagnostic tool for viewing detector Raw Volts

and Calculated Concentrations. This screen is accessed by pressing  from the Diagnostics menu.



Raw Voltage: This is a 0.512 VDC to 4.512 VDC detector output that will be digitized by the microprocessor to generate the calibration curve from which the Raw Concentration and Measured Concentration are derived. The 0.512 volts is equal to 0 ppm and 4.512 volts is equal to the highest factory-set range limit of that component.



Raw Concentration: This value (in engineering units) is calculated from the Raw Volts before linearization and offset and span corrections are applied.

Measured Concentration: This value (in engineering units) is calculated from the Raw Concentration after linearization, offset, gain, gas and humidity corrections have been applied.

From the Raw Values Display screen, the following functions can be useful for diagnosing and monitoring the analyzer's performance:

Press  to change the analyzer's active channel. If the analyzer measures multiple gasses this allows the operator to switch between them. The channel will be indicated in the top left corner of the screen.

Press  to access the [Current Alarms](#) screen. Press  to return to the Raw Values Display screen.

Press  to view the [Diagnostic Values](#) screens. . Press  to return to the Raw Values Display screen.

Press  to open the Zero valve (if your analyzer is equipped with optional calibration valves and analyzer is set to Cal via Valves). **Zero** will be indicated above the range (at the bottom right of the screen). To return to the Measure mode, press F4 again. **Meas** will be indicated above the range on the screen.

Press  to open the Span valve (if your analyzer is equipped with optional calibration valves and analyzer is set to Cal via Valves). **Span** will be indicated above the range (at the bottom right of the screen). To return to the Measure mode, press F4 again. **Meas** will be indicated above the range on the screen.

To change ranges, use the Up/Down arrows  . The current range is shown in the bottom-right corner. **Example: R3: 500.**

If the analyzer's AutoRange function is turned on, the operator will not be able to manually change ranges until AutoRange is turned Off. When AutoRange is turned On, it is indicated with an **A** before the range: **Example: AR3: 500.**

I/O Status

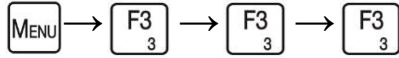



I/O Status
F1 Analyzer Digital Outputs
F2 Analyzer Digital Inputs
F3 Programmable Digital Out

The I/O Status menu gives the operator a choice of viewing the statuses of the analyzer's digital outputs or digital inputs (open or closed). To access the I/O Status

menu, press  from the Diagnostics menu.

Press  to view the status of the analyzer's standard digital outputs.

Press  to view the status of the analyzer's digital inputs.

Press  to view the status of the Programmable Digital Outputs.

Analyzer Digital Outputs



Analyzer Digital Outputs		
Pin	Function	Status
M7	AutoRange	Open
M8	RRange 1	Open
M9	RRange 2	Open
M10	RRange 3	Open
M11	RRange 4	Closed
M22	Zero Gas	Open
M23	Span Gas	Closed
M24	Sample Gas	Open
M25	In Remote	Closed
M26	In Calib.	Closed

The Analyzer Digital Outputs screen allows the operator to view the status of an analyzer output (Open or Closed) and where to find the corresponding pin number.

To access the Analyzer Digital Outputs status screen, press  from the I/O Status menu.

The Pin column indicates the connector and the pin number that are used to control the digital output function. **In the example (M7)**, **M** is the Main Connector on the analyzer's back panel, and **7** is the Pin Number on that connector.

The **Status** becomes closed when the function is true. In the example above, the analyzer is in Range 4. Range 4's status is closed. This will result in a closed contact to digital ground. It can be measured from the Main Connector Pin 6 (digital ground) to the Main Connector Pin 11.

NOTE: These analyzer functions are not user-changeable and have static pin outs. These screens are for viewing only.

Analyzer Digital Inputs





Analyzer Digital Inputs		
Pin	Function	Status
M12	AutoRange	Open
M13	Range1	Open
M14	Range2	Open
M15	Range3	Open
M16	Range4	Open
M17	AutoCal	Open
M18	CalCheck	Open
M19	Zero	Open
M20	Span	Open

Next page ▶ Page 1

The Analyzer Digital Inputs screen allows the operator to view the status of an analyzer input (Open or Closed) and where to find the corresponding pin number.

To access the Analyzer Digital Inputs status screen, press  from the I/O Status menu.

As indicated at the bottom of the screen, press the left and right arrow buttons   to scroll to different Analyzer Digital Input screens.

The Pin column indicates the connector and the pin number that are used to control the function. **In the example (M12)**, **M** is the Main Connector on the analyzer's back panel, and **12** is the Pin Number on that connector. The abbreviations are as follows:

M = Main Connector

A = Auxiliary

Int = Internal, for CAI use only.

When the analyzer is in Remote Mode and the digital input is pulled to digital ground (Main Connector, Pin 6), the status will become Closed.

NOTE: These analyzer functions are not user-changeable and have static pin outs. These screens are for viewing only.



Programmable Digital Outputs



Programmable Digital Outputs					
AUX Pin	DO	Function	Status		
5 to 9	1	Samp P	Closed		
5 to 10	2	Off	Open		
5 to 11	3	Off	Open		
5 to 12	4	Off	Open		
6 to 13	5	Off	Open		
6 to 14	6	Off	Open		
6 to 15	7	Off	Open		
6 to 16	8	Off	Open		
Next page ▶			Page 1		

The Programmable Digital Outputs screen allows the operator to check the status of the analyzer's programmable digital outputs (Open or Closed) according to pin

numbers and programmed functions. From the I/O Status menu, press  to view Programmable Digital Output statuses.

As indicated at the bottom of the screen, press the left and right arrow buttons   to view the next or previous page of Programmable Digital Output statuses.

The column key is as follows:

Aux Pin = Auxiliary connector on the back panel and pin number on the connector

DO = Programmable digital output number

Function = Operator-programmed function

Status = The state the programmed relay is in (open or closed)

NOTES:

- To set functions, see [Programmable Digitals](#).
- Programmed statuses are closed when true.
- Programmed alarms are open when true.

Status Line



Status Line	OFF
F1	Turn Status Line On
F2	Turn Status Line Off

The AK Command Status Line can be displayed at the top of the Measure Screen.

This field contains the current AK Protocol information. See [AK Protocol](#). The current status is shown in the upper-right corner of the Status Line menu. **Example above: OFF.**

From the Diagnostics menu, press  to select On or Off.

Press  from the Status Line menu to turn the AK Status Line On.

Press  from the Status Line menu to turn the AK Status Line Off.

Example of the Status Line turned on: **K3: SREM**

MEASURE		K3: SREM
CO	450.1	R3-500.0 ppm
CO2	7.995	R3-10.00 %
O2	21.02	R2-25.00 %
◀ F1: Channel ▶		
Tue May 15 22:04:36 2001		

Setup Menu





Setup
F1 Measure Settings
F2 Output Settings
F3 TCP/IP Parameters
F4 Data Logging Time
F5 Auto Start Settings
F6 Clock

The Setup menu provides access to key setup screens including Measure Settings,

Output Settings and TCP/IP Parameters. From the Menu screen press  to access the Setup menu.

Press  to access the Measure Settings menu. These setup screens allow the operator to view or change Averaging times and compensation factors.

Press  to access the Output Settings menu. The Programmable Analog and Programmable Digital outputs can be viewed or set up to fit the operator's needs.

Press  to view or change the current TCP/IP parameters.

Press  to access the Data Logging Time screen. (For CAI use only)

Press  to view or make changes to the Auto Start Settings.

Press  to view or change the analyzer's time and date.

Measure Settings

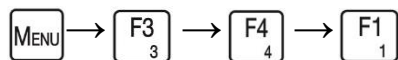

Measure Settings
F1 Averaging Time
F2 Comp Factors
F3 Dilution

The Measure Settings menu provides access to the following Setup parameters:

Averaging Time and Compensation Factors. The Measure Settings menu is accessed

by pressing  from the Setup menu.

Press  to view or change the Averaging Time of the measured concentration.

Press  to view or change Compensation Factors.

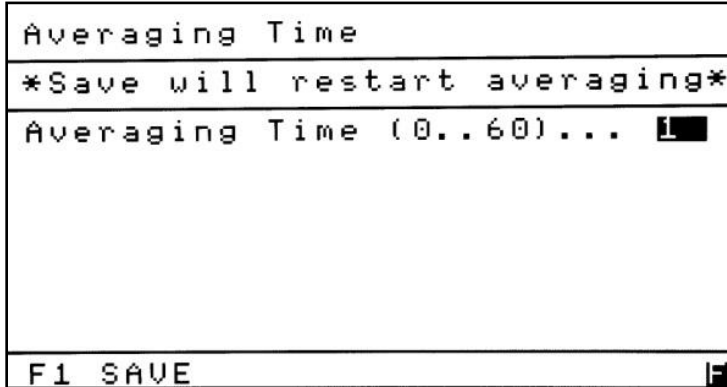

Press  to view or set the Dilution ratio settings. (Special software option)

Averaging Time



The Averaging Time screen allows the operator to set the averaging time of the measured concentration. From Measure Settings menu press  to access the Averaging Time screen.

The Averaging Time is a sliding average. As shown above, it can be set from 0 – 60 seconds.

Press  to open the field to change the time. After making your change, press  again to close the field. Press  to save your changes and restart the averaging of the measured concentration. You will return to the Measure Settings menu.

Comp Factors



Comp Factors	
F1	Temperature Compensation
F2	Pressure Compensation
F3	H2O Compensation
F4	Gas Compensation

Temperature Compensation

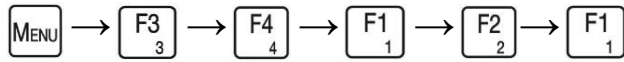

Temperature Compensation	
A	0.01980
B	0.99000
Enabled No	
F1 SAVE F2 Restore Factory	
↔ Change Channel...	CO2

Pressure Compensation

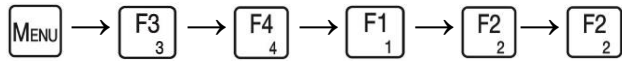

Pressure Compensation	
Range Limits	C Value
R1: 20.0	0.53832
R2: 0.0	0.53832
R3: 0.0	0.53832
R4: 0.0	0.53832
Enabled Yes	
F1 SAVE F2 Restore Factory	
↔ Change Channel... CO2	

H₂O Compensation

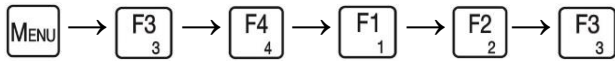

H2O Compensation	
Dry	0.00000
AH	0.00000
BH	0.00000
F1 SAVE	
↔ Change Channel...	CO

Gas Compensation

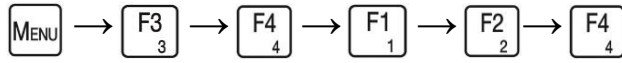

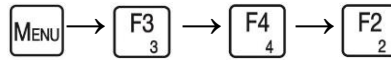

Gas Compensation	
Comp Channel	CO2
Start Point	1.0000000e+00
a0	0.0000000e+00
a1	0.0000000e+00
a2	0.0000000e+00
a3	0.0000000e+00
a4	0.0000000e+00
F1 SAVE F2 Restore Factory	
↔ Change Channel... CO	

Output Settings



Output Settings
F1 Programmable Analogs
F2 Programmable Digitals

The Output Settings menu allows the operator to change the analyzer's Programmable Analog and Programmable Digital outputs to suit the operator's needs. The Output Settings menu is accessed by pressing  from the Setup menu.

Press  to see the Programmable Analogs menu, which allows the operator to view or change the analog Output Assignments, Output Scaling or make Output Adjustments.

Press  to see the Programmable Digitals menu, which allows the operator to view or change the Digital Output Assignments, choose Output Hold or Clear, or conduct an Output Test.

Programmable Analogs





Programmable Analogs
F1 Output Assignments
F2 Output Scaling
F3 Output Adjustments

The Programmable Analogs menu provides access to the following Setup parameters: Output Assignments, Output Scaling and Output Adjustments. The

Programmable Analogs menu is accessed by pressing  from the Output Settings menu.

Press  to view or reassign the four programmable analog output signals.

Press  to view or set the output scaling of programmable analog output signals.

Press  to set or adjust the analog outputs. The operator can set the output to either current or voltage, and calibrate the outputs to exactly match the results obtained on a PLC or other remote data-recording device.



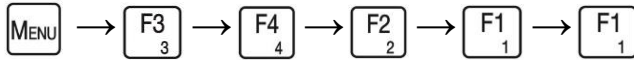



Output Assignments



Output Assignments	
Output	Signal
AO-1	Channel1
AO-2	Channel2
AO-3	Channel2
AO-4	Channel2
F1 SAVE	

The Output Assignments screen allows the operator to view or change the signals assigned to the programmable analog outputs. From the Programmable Analogs menu

press  to access the Output Assignments screen.

Use the Up/Down arrows   to highlight the field you intend to change. Press  to open the field and use the Up/Down arrows   to change it to the desired signal. Press  again to close the field. Press  to save your changes.

NOTES:

1. Analog Output 1 (for example) is listed as AO-1 in the Output column.
2. For information on analog output connections see [Analog and Digital Interface](#).

The following output signals can be programmed by the operator using the Output Assignments screen:

Channel1: Measured concentration of Channel 1

Channel2: Measured concentration of Channel 2

Channel3: Measured concentration of Channel 3

Flow1: Calculated flow of Channel 1

Flow2: Calculated flow of Channel 2

Flow3: Calculated flow of Channel 3

Ext1: Spare input for CAI

Ext2: Voltage from Humidity sensor if equipped

Pressure: Barometric pressure measured at output of Channel1

Temp: Internal analyzer case temperature

Temp.Ch1: Temperature of channel 1 detector

Temp.Ch2: Temperature of channel 2 detector

Temp.Ch3: Temperature of channel 3 detector

EPC.Ch1: % of voltage supplied to open Cannel 1 EPC if equipped with flow control

EPC.Ch2: % of voltage supplied to open Cannel 1 EPC if equipped with flow control



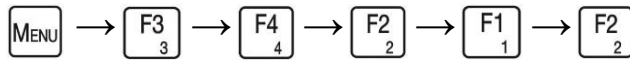

EPC.Ch3: % of voltage supplied to open Cannel 1 EPC if equipped with flow control

Output Scaling



Output Scaling		
Default scaling use 0.00		
Output	Lower	Upper
AO-1	0.00	0.00
AO-2	0.00	0.00
AO-3	0.00	0.00
AO-4	0.00	0.00
F1 SAVE		

The **Output Scaling** screen allows the operator to scale the analyzer's **Analog Outputs** to a specific value for each of the four output signals. This is generally used for scaling of temperatures or pressures, but it can also be used to set an output for a specific concentration. From the Programmable Analogs menu press  to access the Output Scaling screen.

Use the Up/Down arrows   to highlight the field you intend to change. Press  to open the field to change the value. After making your change, press  again to close the field. Press  to save your changes and return to the Programmable Analogs menu.

NOTES:

- Analog Output 1 is indicated as AO-1 in the Output column.
- 0 to 10 VDC output is used for the following three examples:

EXAMPLES:

1. When the analog [Output Assignment](#) is set for Detector Temperature and the lower setting is set to 0.00 and the upper setting is set to 100.00, 50°C will = 5.0 VDC.
2. When the analog [Output Assignments](#) are set for concentrations and the default upper and lower settings are 0.00 and 0.00, the default settings allow the output voltage to follow the range limits.

Example: If Range 1 is set to 10 ppm and Range 2 is 100 ppm, in Range 1 10 ppm will = 10 VDC and in Range 2 100 ppm will = 10 VDC.

3. When the analog [Output Assignment](#) is set for concentrations and the lower setting is set to 0.00 and the upper setting is set to 10.00, the output will no longer follow the range limit and will be locked to 10 ppm or 10% depending on units displayed on Measurement screen.

Example: If Range 1 is set to 10 ppm and Range 2 is 100 ppm, in Range 1 10 ppm will = 10 VDC and in Range 2 10 ppm will = 10 VDC.

Output Adjustments

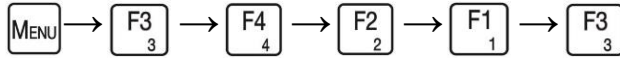











Output Adjustments			
Output Type...			ENTER
Output	%FS	Offset	Gain
AO-1	Meas	0.8303	0.8297
AO-2	Meas	0.8324	0.8293
AO-3	Meas	0.8253	0.8225
AO-4	Meas	0.8275	0.8235
F1 SAVE			ENTER







The Output Adjustments screen allows the operator to set the output to either mA or voltage and calibrate the outputs to exactly match the results obtained on a PLC or other remote data-recording device. Using the Output Adjustments screen, the operator can force the analog outputs to 0%, 50% or 100% of Full Scale and back to Measure. For information on analog output connections see [Analog and Digital Interface](#).

From the Programmable Analogs menu press  to access the Output Adjustments screen.

- **Output Type** can be set for mA or 1, 5 or 10 VDC.
- **Output AO-1** refers to analog output 1.
- **% FS** is used to toggle between Measurement, 0%, 50% and 100% Full Scale.
- **Offset** (zero) is used to adjust the output at 0%.
- **Gain** (span) is used to adjust the output at 100%.

To select the **Output Type** press  to open the highlighted field. Use the Up/Down arrows   to make your selection. Press  again to close the field.

Once the output type has been selected, use the Left/Right arrows   to move the highlight into the % FS column of the output to be checked. Press  until the % FS value reads 0.000. To adjust the zero (Offset), use the Left/Right arrows   to highlight the Offset column and press  to open the field. Make a small adjustment to the Offset value and then press  to close the field. Repeat this procedure as necessary.

To adjust the output to Full Scale, use the Left/Right arrows   to move the highlight into the % FS column and press  until the % FS column value reads 100.0. Then use the Left/Right arrows   to highlight the Gain column. Press  to open the field. Make a small adjustment and press  again to close the field and check the output. Repeat this procedure as necessary for other outputs.

When you are finished making all your changes press  to save them. You will return to the Programmable Analogs menu.

NOTE: Failure to save your adjustments will result in the numbers reverting back to the defaults after power is turned off and back on.

The following table includes typical Programmable Analog Output values:

OUTPUT	OFFSET	GAIN
0-20 mA	0.000	0.828
4-20 mA	1.658	0.662
0-1 V	0.828	0.828
0-5 V	0.828	0.828
0-10 V	0.828	0.828

Programmable Digitals





Programmable Digitals
F1 Output Assignments
F2 Output Hold/Clear... Clear
F3 Output Test

The Programmable Digitals menu provides access to the analyzer’s digital outputs for viewing and changing Output Assignments, holding or clearing alarms, and testing the outputs. The Programmable Digitals menu is accessed by pressing  from the Output Settings menu.

From the Programmable Digitals menu:

Press  to assign any of the 15 programmable digital outputs to a specific alarm or status.

Press  to set the programmable digital alarms to hold or clear after the alarm is gone. The current Output Hold/Clear status is shown on the right side of the Programmable Digitals screen after the ellipsis (...). **Example: Output Hold/Clear. . . Clear.**

Press  to access the Output Test screen.

Output Assignments

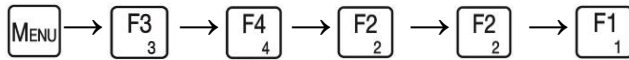



Output Assignments			
15 programmable outputs			
1	Sample	2	Off
2	Off	4	Off
3	Off	6	Off
4	Off	8	Off
5	Off	10	Off
6	Off	12	Off
7	Off	14	Off
8	Off		
9	Off		
10	Off		
11	Off		
12	Off		
13	Off		
14	Off		
15	Off		



F1 SAVE

The Output Assignments screen allows the operator to assign any of the 15 programmable digital outputs to a specific alarm or status. From the Programmable

Digitals menu press  to access the Output Assignments screen.

Use the left and right arrow buttons   to highlight the field you intend to change.

Press  to open the field and use the up or down arrow button   to change

the signal. Press  again to close the field. Press  to save your changes.

NOTES:

1. For information on digital output connections see [Analog and Digital Interface](#).
2. Alarms go open when present and statuses go closed when the state is true.
3. See the following tables for a list of Alarms and Statuses:

Programmable Digital Output List

Alarms

- **F1** – Channel 1 Flow
- **F2** – Channel 2 Flow
- **F3** – Channel 3 Flow
- **E1** – External 1
- **E2** – External 2
- **P** – Output Pressure (Baro)
- **T** – Analyzer Temperature
- **1NC** – Channel 1 not calibrated
- **2NC** – Channel 2 not calibrated
- **3NC** – Channel 3 not calibrated
- **1LoC** – Channel 1 conc. 1
- **2LoC** – Channel 2 conc. 1
- **3LoC** – Channel 3 conc. 1
- **1HiC** – Channel 1 conc. 2
- **2HiC** – Channel 1 conc. 2
- **3HiC** – Channel 1 conc. 2
- **1DT** – Ch1 Detector temperature
- **2DT** – Ch2 Detector temperature
- **3DT** – Ch3 Detector temperature
- **1EV** – Ch1 EPC Voltage
- **2EV** – Ch2 EPC Voltage
- **3EV** – Ch3 EPC Voltage
- **1OR** – Ch1 Over Range
- **2OR** – Ch2 Over Range
- **3OR** – Ch3 Over Range
- **1AO** – Ch1 ADC Over Range
- **2AO** – Ch2 ADC Over Range
- **3AO** – Ch3 ADC Over Range
- **1AU** – Ch1 ADC Under Range
- **2AU** – Ch2 ADC Under Range
- **3AU** – Ch3 ADC Under Range
- **OFF** – Not set
- **G** – General Alarm

Statuses

- **R** – In Remote
- **1CA**– Channel 1 not Calibrated
- **2CA**– Channel 2 not Calibrated
- **3CA**– Channel 3 not Calibrated
- **1AR** – Ch1 in Auto Range
- **1R1** – Ch1 in Range 1
- **1R2** – Ch1 in Range 2
- **1R3** – Ch1 in Range 3
- **1R4** – Ch1 in Range 4
- **1IC** – Ch1 in Calibration
- **1Z** – Ch1 in Zero
- **1S** – Ch1 in Span
- **1Sa** – Ch1 in Sample
- **2AR** – Ch2 in Auto Range
- **2R1** – Ch2 in Range 1
- **2R2** – Ch2 in Range 2
- **2R3** – Ch2 in Range 3
- **2R4** – Ch2 in Range 4
- **2IC** – Ch2 in Calibration
- **2Z** – Ch2 in Zero
- **2S** – Ch2 in Span
- **2Sa** – Ch2 in Sample
- **3AR** – Ch3 in Auto Range
- **3R1** – Ch3 in Range 1
- **3R2** – Ch3 in Range 2
- **3R3** – Ch3 in Range 3
- **3R4** – Ch3 in Range 4
- **3IC** – Ch3 in Calibration
- **3Z** – Ch3 in Zero
- **3S** – Ch3 in Span
- **3SA** – Ch3 in Sample

General Alarms

- Channel 1 Flow
 - Channel 2 Flow
 - Channel 3 Flow
 - External 1
 - External 2
 - Output Pressure (Baro)
 - Analyzer Temperature
 - Ch1 Detector temperature
 - Ch2 Detector temperature
 - Ch3 Detector temperature
 - Ch1 EPC Voltage
 - Ch2 EPC Voltage
 - Ch3 EPC Voltage
 - Ch1 ADC Over Range
 - Ch2 ADC Over Range
 - Ch3 ADC Over Range
 - Ch1 ADC Under Range
 - Ch2 ADC Under Range
 - Ch3 ADC Under Range
-

Output Hold/Clear

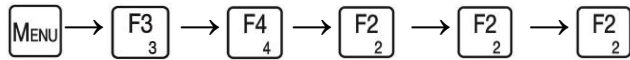

Output Hold/Clear	Clear
F1 Hold Outputs	
F2 Clear Outputs	

The Output Hold/Clear menu allows the operator to choose whether to hold or clear a triggered alarm when the alarm is no longer present. The current status is shown in the upper-right corner of the Output Hold/Clear menu. The Output Hold/Clear menu is accessed by pressing  from the Programmable Digitals menu.

Press  to hold programmed alarm outputs until they are manually cleared.

Press  to set the outputs to automatically clear when alarms are no longer present.

NOTES:

- To manually clear held alarms, press  from this menu. An output alarm cannot be cleared until the alarm is back within its limits.
- Once the outputs are cleared, the outputs will not hold on alarms until they are set back to Hold.

Output Test

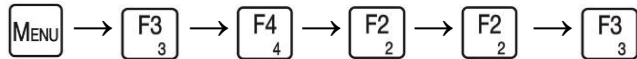

Output Test			
Must reboot after testing			
1	Open	2	Open
3	Open	4	Open
5	Open	6	Open
7	Open	8	Open
9	Open	10	Open
11	Open	12	Open
13	Open	14	Open
15	Open		
F1 ALL			

The Output Test Screen allows the operator to test the Programmable Digital Outputs to make sure they are functioning properly. The Output Test Screen is accessed by pressing





F3₃



from the Programmable Digitals menu. The Output Test Warning screen first appears, asking if you wish to continue the output test. If you proceed with the test, you **must** reboot the analyzer to exit the output test.

Output Test	
WARNING	
Going into the Output Test will require you to REBOOT the analyzer after you are done testing the outputs	
Would you like to continue?	
F1	Yes
F2	No

To exit the Output Test screen and proceed with normal operation press **F2**₂. To continue to the

Output Test screen press **F1**₁. For information on output connections see [Analog and Digital Interface](#).

To test outputs one at a time, use the Up/Down arrows   to highlight the desired output, then press  to change the state of the output (open or closed). Press  again to change the state back.

To test all the outputs at once, press  to change the state of all the outputs (they are all Open in the example). Press  again to change all the output states back.

Upon completion of the test, you will be required to reboot the analyzer to resume operation.

TCP/IP Parameters

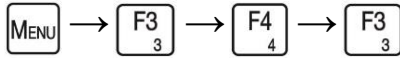

TCP/IP Parameters	
Must REBOOT after saving	
HWaddress	00.E0.4B.1A.FA.B0
IP-address	192.168.002.092
Netmask	255.255.255.000
Port	7700
Gateway	000.000.000.000
WinIfPort	2000
F1 SAVE	



The TCP/IP Parameters screen is used for setting up the parameters for communication between an analyzer and computer. The TCP/IP Parameters screen is accessed by pressing



 from the Setup menu.

TCP (Transmission Control Protocol) is a standard protocol for sending information between devices connected to a computer network. It includes a format of packets, also called datagrams.

IP (Internet Protocol) specifies the addressing scheme. Most networks combine IP with TCP, establishing a virtual connection between destination and source.

The IP-address, Netmask and Gateway may be defined by the user. The Port and WinIfPort are assigned 7700 and 2000 by CAI and should not be changed unless required for a certain location.

Use the Up/Down arrows   to move the highlight to the setting you wish to change.

Press  to open the field to change the value. After making your change, press  again to

close the field. Press  to save your changes and return to the Setup menu. The new settings will take effect after the analyzer is rebooted.

Data Logging Time

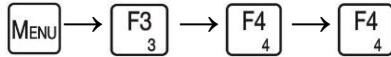

```



Data Logging Time
-----
There are 16 user timed data
log files.

Each holds 1800 data lines.
The minimum time is 1 second.
At 1 Sec. each file holds
30 minutes of snapshot data.
-----
Logging Interval 0=Off... 0
-----
F1 SAVE
  
```

Data logging allows the analyzer to store internal variables to support CAI

troubleshooting. When troubleshooting with CAI Technical Support, the operator may be asked to turn this feature on. These files can only be accessed by CAI. To access the Data Logging

screen, press  from the Setup menu.

To turn Data Logging on, press  to open the field, and change the Logging Interval from 0 to the desired time (in seconds). After making your change, press  again to close the field.

Press  to save your change and return to the Setup menu.

To turn Data Logging off change the interval to 0 and press  to save.

Auto Start Settings

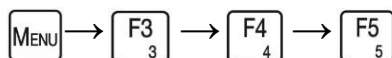

Auto Start Settings		
Startup Mode		Meas
Auto Startup		Off
Wait for [min]		0
Access Level		2
Remote/Manual		Manual
Calibrations	CO	00
Calibrations	CO2	00
Calibrations	O2	00
Startrange	CO	00
Startrange	CO2	00
Startrange	O2	0
F1 SAVE		

The Auto Start Settings screen allows the operator to set parameters that will take effect upon power up of the analyzer. The Auto Start Settings screen is accessed by pressing  from the Setup menu.

Note:

The **Startup Mode** is always active whether or not Autostart is turned on. This allows the operator to choose to bootup in Standby or Measure mode. If the Auto Startup function is turned off, the analyzer will boot up with the same settings the analyzer was last in with the exception of Startup Mode. The operator can set the following parameters:

Startup Mode – Always active whether Auto Startup is turned on or off. Determines whether the analyzer will boot up in Measurement or Standby mode

Auto Startup – Turn the Auto Startup function on or off.





Wait for (min) – Allow for the time it takes for the analyzer to warm up before calibration.

Access Level – Select the Operator Security Level.

Remote/Manual – Set whether the analyzer starts up in Remote or Manual mode.

Calibrations – Set the number of calibrations the analyzer will perform.

Start Range – Specify the range to set upon Power Up.



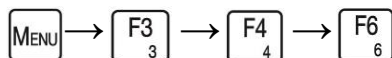

To change a setting, use the Up/Down arrows   to move the highlight to the setting you wish to change. Press  to open the field to change the value. After making your change, press  again to close the field. Press  to save your changes and return to the Setup menu.

Clock Settings



Clock	
Current System Time Sat Jun 07 10:51:31 2013	
Change Time and Date	
Weekday	Tue
Date (mm.dd.yy)	Jun 07 2013
Time (HH:MM:SS)	10:49:08
F1 SAVE	

The Clock Settings screen allows the operator to set the analyzer's internal clock. The internal clock is used for auto calibrations and data time stamping. The Clock Settings screen is accessed by pressing  from the Setup menu.

To change a setting, use the Up/Down arrows   to move the highlight to the setting you wish to change. Press  to open the field to change the value. After making your change, press  again to close the field. Press  to save your changes and return to the Setup menu.

Alarms Menu





Alarms
F1 Current Alarms
F2 Alarm Log
F3 Alarm Limits
F4 Alarm Display On/Off...On

The Alarms menu allows the operator to view **Current Alarms**, the **Alarm Log** and settable **Alarm Limits**. From the Menus screen press  to access the Alarms menu.

Press  to access the Current Alarms screen and view the alarms that are currently active.

Press  to access the Alarm Log. The operator can view a log of the last 40 alarms.

Press  to access the Alarm Limits menu. The operator can view or change the existing alarm limits.

Press  to turn On or Off the display of the active alarms that scroll across the bottom of the Measure screen. The current setting is shown on the Alarms menu on the right side of the screen after the ellipsis (...). **Example: Alarm Display. . . On.**

Current Alarms

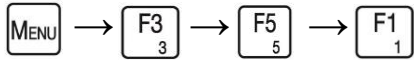

Current Alarms			
Samp P	Air P	SEPC	AEPC
ConvT		DiodeT	CellIT
R1	NC		

F1 Refresh

The Current Alarms screen allows the operator to view the analyzer's current alarms at the time this screen was accessed. To access the Current Alarms screen press  from the Alarms menu.

Press  to refresh this screen. (This screen does not auto refresh.)

Alarm Log

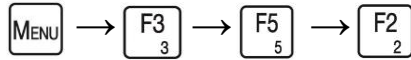

Screen Name			Alarm Abbreviation				Alarm Status			
Year / Month / Day			Hour / Minute		Alarm Value					
Alarm Log										
Yr	Mon	Da	Hr	Mn	Al	la	r	m	Ua	l
13	Jun	07	10	27	SE	PCC	U	4.5	0000	OFF
13	Jun	07	10	27	AE	PCC	U	4.5	0000	OFF
13	Jun	07	10	27	RC	PCC	U	0.0	0000	OFF
13	Jun	07	10	27	Lo	Co	cc	0.1	0000	OFF
13	Jun	07	10	27	Hi	Co	cc	0.1	0000	OFF
13	Jun	07	10	26	SP	Pres	s	3.8	47	ON
13	Jun	07	10	26	AP	Pres	s	14.9	8	ON
13	Jun	07	10	26	Ov	en	T	85.0	00	ON
13	Jun	07	10	26	Co	n	v	205.0	00	ON
13	Jun	07	10	26	Pu	m	p	84.9	8	ON

The Alarm Log allows the operator to view the analyzer’s last 40 alarms and their current

statuses. Press **F2** to access the Alarm Log screen from the Alarms menu.

Press **F1** to view the next page.

Press **F2** to return to the previous screen.

Alarm Limits

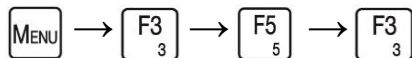



Alarm Limits
F1 temperatures
F2 Pressures
F3 Voltages
F4 Concentrations
F5 Flows

The Alarm Limits menu allows the operator to view or change the current upper and lower alarm tolerances. When the signals go above or lower than the assigned limit an alarm is

triggered. To access the Alarm Limits menu, press  from the Alarms menu.

Press  to access the Temperatures screen. It allows the operator to set the upper and lower temperature alarm limits.

Press  to access the Pressures screen. It allows operator to set the upper and lower alarm limits for sample and air pressure.

Press  to access the EPC voltage % screen. It allows the operator to view or change the existing alarm limits of the EPC voltage % being supplied to the EPC valve.

Press  to access the Concentration Alarms screen. It allows the operator to view or change the upper and lower gas concentration alarm limits.

Temperatures









Temperature [°C]		
Alarms	LoLimit	HiLimit
Cell	65.00	69.00
Diode	-5.50	-4.50
Conv	204.00	210.00
F1 SAVE		

From the Alarm Limits menu, press to access the Temperatures screen. Use the left or right arrow to highlight the alarm limit you wish to change. Press to open the field to change the value. After making a change, press again to close the field. Press to save your changes.

Pressures



Pressure [psi]		
Alarms	LoLimit	HiLimit
Baro	11.00	15.00
F1 SAVE		



From the Alarm Limits menu, press  to access the Pressures screen. Use the left or right arrow   to highlight the alarm limit you intend to change. Press  to open the field to change the value. After making a change, press  again to close the field. Press  to save your changes.

Voltages



Voltages [%]		
Alarms	LoLimit	HiLimit
Ext 1	-1.00	10.00
Ext 2	-1.00	10.00
EPC 1	-1.00	90.00
EPC 2	-1.00	90.00
EPC 3	-1.00	90.00

F1 SAVE

From the Alarm Limits menu, press **F3₃** to access the EPC Voltage Alarm Limits screen. Use the left or right arrow   to highlight the alarm limit you intend to change. Press **ENTER** to open the field to change the value. After making a change, press **ENTER** again to close the field. Press **F1₁** to save your changes.









Concentrations



Concentration Alarms [ppm]			
Alarms	Limit	Type	
Conc 1	3000.00	Hi	Lo/Hi
Conc 2	3000.00	Hi	Lo/Hi
F1 SAVE			

Concentration alarms can be set to trigger an alarm below or above a specified

concentration. From the Alarm Limits menu, press  to access the Concentration Alarm Limits screen.

Use the left or right arrow   to highlight the concentration alarm limit you intend to change. Press  to open the field to change the value. After making a change, press  again to close the field. After the concentration limit is set, specify whether the alarm will be set for a High or Low alarm. Use the left or right arrow   to highlight the alarm type (High or Low). Press  to toggle between Hi or Lo. Press  to save your changes.

To set the alarm to a digital output, see Programmable Digital [Output Assignments](#).

Alarm Display On/Off

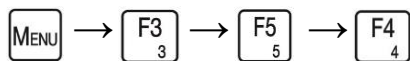



Alarm Display On/Off	On
F1 Turn Alarm Display On	
F2 Turn Alarm Display Off	

The Alarm Display On/Off menu allows the operator to turn On or Off the Alarm Display that scrolls across the bottom of the Measure screen. Programmed digital output alarms will not be affected by this setting; only the display will be turned off. The scrolling alarms will be replaced with the CAI phone number when an alarm is active. If there are no alarms, only the date and time will be displayed.

Press  from the Alarms Menu to access this menu. The current setting is shown in the upper-right corner of the Alarm Display menu. (In the above example, On.)

From the Alarm Display On/Off menu:

Press  to turn the Alarm Display On.

Press  to turn the Alarm Display Off.

Service



Service
F1 Linear Coefficients
F2 Service Menu

The Service Menu is for advanced operators and CAI Service. The Service menu provides access to operator-level linear coefficients and CAI Service Menu. From the Menu screen press  to access the Service menu. Changing the values from these screens will affect performance of the analyzer. Consult with a CAI representative before making any adjustments.

Press  to view or change operator-level linear coefficients.

Press  to access the Service Menu. (Temperature, Pressure and Amplifier adjustment)

Linear Coefficients

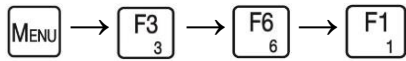

Linear Coefficients
F1 Range 1
F2 Range 2
F3 Range 3
F4 Range 4

The Linear Coefficients function allows the operator to optimize linearity by inputting up to five coefficients for each range to generate up to a fourth-order curve. From the Service









menu press  to access the Linear Coefficients screen.

NOTES:

- Changing linear coefficients can compromise the analyzer's accuracy and ability to function properly.
- To reset Factory Coefficients see Reset Factory Settings.

Select the corresponding function key for the range you wish to edit. In the example,  was pressed to allow the Range 1 Linear Coefficient to be changed.

Range 1	
a0	0.000000e+00
a1	1.000000e+00
a2	0.000000e+00
a3	0.000000e+00
a4	0.000000e+00
F1 SAVE	

Use the Up/Down arrows   to highlight the coefficient you intend to change. Press  to open the field, use the left and right arrow buttons   to position the cursor, and use the Up/Down arrows   or number keys to make your change. Press  again to close the field. Press  to save your changes.

Service Menu

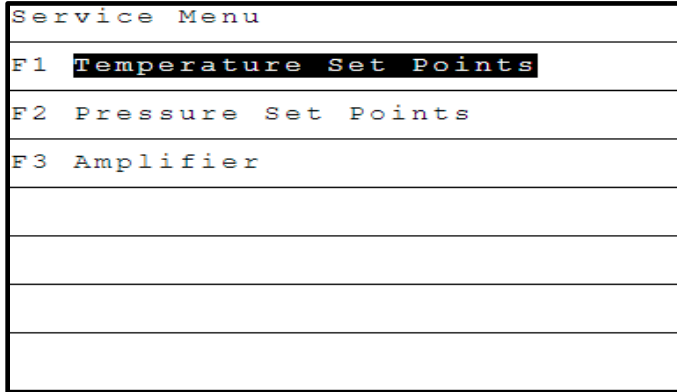
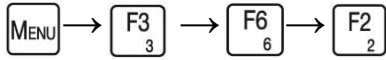

The Service Menu is an advanced service area and should only be accessed after consulting with a CAI representative. This area allows access to Temperature, Pressure and Amplifier zero setpoints. From the Service menu press  to access the Service Menu screen.

Press  to view or change the Temperature control setpoints.

Press  to view or change the Pressure control setpoints.

Press  to view or change the Amplifier zero offset.

Temperature Set Points

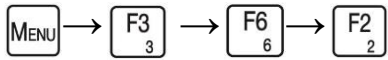

Temperature Setpoints			
Dev	Value	Counts	
Ch1	52.63	2060.00	
Ch2	35.00	2060.00	
Ch3	52.22	2060.00	
F1 SAVE			

Pressure Set Points



Pressure Setpoints			
Dev	Value	Counts	
Ch1	7.20	730.00	
Ch2	7.21	730.00	
Ch3	7.23	730.00	

F1 SAVE

Amplifier Setpoint

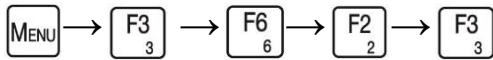

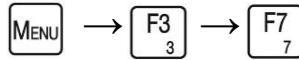

CO Amplifier	Raw Volts
F1 Channel	0.501
F2 Alarms	Raw Conc.
F3 Diagnostics	0.25
F4 Flow Zero	Meas Conc.
F5 Flow Span	0.00
Amp Offset 2070	Meas
F10 SAVE	

Security



Security
F1 Operator Levels
F2 Change Password
F3 Reset Password

The Security menu allows the operator to change the access to Standard or Setup Function menus and change or reset the Setup Function password. From the Menus screen press  to access the Security menu.

Press  to set the operator's access level. The Operator Levels menu allows the operator to choose either Standard Functions or advanced Setup Functions.

Press  to change the password that allows the operator access to the Setup Functions menu.

Press  to enter the master password that resets the Setup Functions password to the original factory setting.

Operator Levels

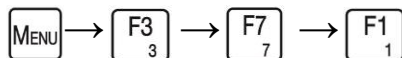

Operator Levels
F1 Standard Functions
F2 Setup Functions
F3 Factory Functions

The 700LX NDIR/O2 has three operator access levels which allow the operator to access different analyzer functions. From the Security Menu screen press  to access the Operator Levels screen. See [Menu Flow Chart](#) for security levels and functions.

Press  to set the operator level to Standard Functions for basic operation and calibration. No password is required.

Press  to set the operator level to Setup Functions for advanced operators. This allows the operator access to all standard functions, setup functions and parameters. Setup Functions requires the operator to enter the password “222.” The analyzer will remain in this level until the operator changes it.

 Factory Functions is for CAI use only.

Change Password

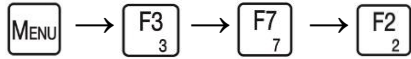

Change Password	
Standard Functions	111
Setup Functions	222
F1 SAVE	

The Change Password screen allows the operator to change the Setup Functions password from the factory-preset 222 to a new password. From the Security menu screen press  to access the Operator Levels screen.

To change the password, press  to open the field.



Enter a new 3-digit password. Press  again to close the field.

Press  to save the new password.

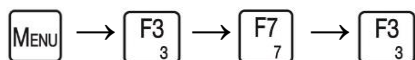
Reset Password



The **Reset Password** screen allows the operator to reset the **Setup Password** to the original **factory password (222)**. From the Security menu screen press  to access the Reset Password screen.

To return the password to the original factory password, you must enter **WIZARD** in the field. Press  to open the field and bring up a cursor. Use the Up arrow  to scroll to **W**. Use the Right arrow  to move to the next letter and scroll to **I** and so on.

Repeat this procedure until you have finished entering **WIZARD**. Press  and the password for the Setup functions will be reset to **222**.

Communication and Interface

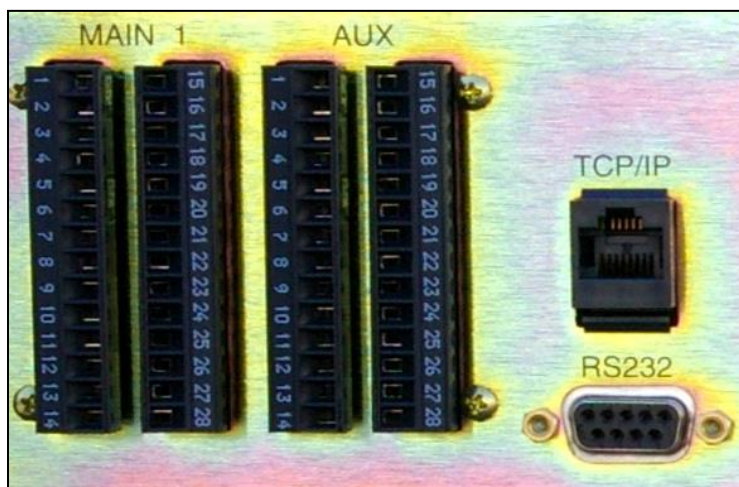

Analog and Digital Interface

The Main and Auxiliary connectors provide the analog outputs for concentrations and other variable signals. Digital Status outputs, Control inputs and Calibration drive signals are also provided. There are four analog outputs, whose type (mA or specific voltage range) and signal assignments are assignable from the Setup menu. See the following tables for pin numbers and functions.

Serial Interface

The 9-pin Serial Interface connector provides RS-232 remote control and data access to the analyzer via the AK protocol.

Network Port

The TCP/IP port allows the analyzer to be accessed via a network connection. The analyzer requires a static IP address that is settable from the Setup menu. The 700LX Analyzer can be remotely accessed via AK or Modbus protocol or, alternatively, via the embedded Remote Web Interface. Visit https://www.gasanalyzers.com/gas_analyzers/non-dispersive-infrared-ndir-analyzers for the Web Interface instruction manual.

Analog and Digital Interface

Hardware Capabilities of Main and Aux Connectors

Analog Output

The operator can choose one of the following output types:

- As voltage outputs – 0 to 1V, 5V or 10V
- As current outputs – 0 to 20 mA or 4 to 20 mA

When set as current outputs, the maximum drive voltage provided by the analyzer is slightly more than 20 Volts, requiring that the maximum loop resistance less than 1K Ohms. Voltage load should be 2K ohms or more. The Isolated Analog Ground (Main, Pin 1) is the only pin that should be used as the return line for the four analog outputs.

See [Programmable Analog Output Adjustments](#).

Digital Output

There are two types of digital outputs:

- Static Digital Outputs – Permanently assigned to often-needed functions. These are opto-isolated, solid-state Normally Open (NO) relays that connect to the Digital Ground (Main, Pin 6 and Pin 28).
- Programmable Digital Outputs – Have dedicated returns for each block of four outputs. Refer to the Aux Connector Pinout chart below to determine which pin is used for the corresponding Programmable Digital Output. When the output is programmed as a status it will close to indicate the function. When programmed as an alarm the output will open to indicate an alarm.

All opto-isolated relays are rated for 48VDC, 0.5 Amp maximum. The user is required to limit the drive current supplied to each input. All inputs are DC only and will not operate on AC current.



CAUTION: Do not connect these pins directly to both sides of a voltage power supply as unrestricted current will damage the relay.

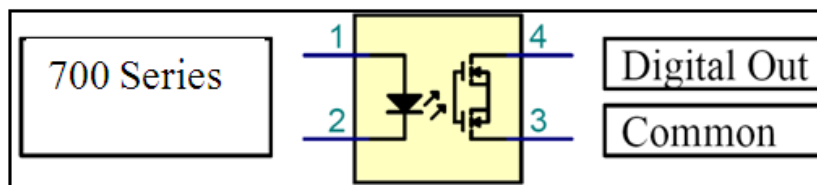

Example of digital output driver.

Digital Input

The analyzer's Digital Inputs are internally pulled up to 5VDC and are operated by user equipment connecting an input to the Digital Ground (Main, Pin 6). Note that some lines require only momentary operation (250ms), and some selection lines are intended to be held continuously. Analyzer must be in remote mode.

DRV

The calibration gas valve drivers are application-specific and intended for solenoid valve drive. 24VDC valves with a maximum wattage of 12 Watts should be used. The 24VDC used to operate the valves should be connected to the coils, and the analyzer inputs when operating will pull the valve current to Digital Ground.

24VDC

The 24VDC output is intended for use with properly rated solenoid valves. **CAUTION:** Use of this output for other purposes can damage the analyzer.

Analog Input

The Analog Input is reserved for factory signals. **CAUTION:** Do not connect to this input or damage may occur.

28-Pin Main (BPM) Connector Assignments

Pin #	Signal	Signal Type	Operation
1	Isolated Analog Ground	Analog Output	Isolated Analog Ground
2	User-Defined AO-1	Analog Output	1V, 5V, 10VDC or mA
3	User-Defined AO-2	Analog Output	1V, 5V, 10VDC or mA
4	User-Defined AO-3	Analog Output	1V, 5V, 10VDC or mA
5	User-Defined AO-4	Analog Output	1V, 5V, 10VDC or mA
6	Digital Ground	Digital Ground	Digital Ground
7	Sense Auto Range	Digital Output	NO Relay to Digital Ground
8	Sense Range 1	Digital Output	NO Relay to Digital Ground
9	Sense Range 2	Digital Output	NO Relay to Digital Ground
10	Sense Range 3	Digital Output	NO Relay to Digital Ground
11	Sense Range 4	Digital Output	NO Relay to Digital Ground
12	Set Auto Range	Digital Input	Momentary Hold to Ground
13	Control Range 1	Digital Input	Momentary Hold to Ground
14	Control Range 2	Digital Input	Momentary Hold to Ground
15	Control Range 3	Digital Input	Momentary Hold to Ground
16	Control Range 4	Digital Input	Momentary Hold to Ground
17	Auto Cal	Digital Input	Momentary Hold to Ground
18	Calibrate	Digital Input	Momentary Hold to Ground
19	Zero	Digital Input	Momentary Hold to Ground
20	Span	Digital Input	Momentary Hold to Ground
21	Sample	Digital Input	Momentary Hold to Ground
22	Zero Gas Flow	Digital Output	DRV
23	Span Gas Flow	Digital Output	DRV
24	Sample Gas Flow	Digital Output	DRV
25	Local/Remote	Digital Output	NO Relay to Digital Ground
26	Read Cal Mode	Digital Output	NO Relay to Digital Ground
27	24 VDC	24 VDC	24 VDC
28	Digital Ground	Digital Ground	Digital Ground

28-Pin Auxiliary (BPA) Connector Assignments

Pin #	Signal	Signal Type	Operation
1	Analog Ground	Analog Input	Analog Ground
2	Reserved	Analog Input	Reserved
3	Reserved	Analog Input	Reserved
4	Reserved	Analog Input	Reserved
5	Relay RTN 1	Digital Output	RTN Relays 1 - 4
6	Relay RTN 2	Digital Output	RTN Relays 5 - 8
7	Relay RTN 3	Digital Output	RTN Relays 9 - 12
8	Relay RTN 4	Digital Output	RTN Relays 13 - 15
9	User-Defined NO Relay 1	Digital Output	Uses Relay RTN 1
10	User-Defined NO Relay 2	Digital Output	Uses Relay RTN 1
11	User-Defined NO Relay 3	Digital Output	Uses Relay RTN 1
12	User-Defined NO Relay 4	Digital Output	Uses Relay RTN 1
13	User-Defined NO Relay 5	Digital Output	Uses Relay RTN 2
14	User-Defined NO Relay 6	Digital Output	Uses Relay RTN 2
15	User-Defined NO Relay 7	Digital Output	Uses Relay RTN 2
16	User-Defined NO Relay 8	Digital Output	Uses Relay RTN 2
17	User-Defined NO Relay 9	Digital Output	Uses Relay RTN 3
18	User-Defined NO Relay 10	Digital Output	Uses Relay RTN 3
19	User-Defined NO Relay 11	Digital Output	Uses Relay RTN 3
20	User-Defined NO Relay 12	Digital Output	Uses Relay RTN 3
21	User-Defined NO Relay 13	Digital Output	Uses Relay RTN 4
22	Reserved	Reserved	Reserved
23	Reserved	Reserved	Reserved
24	Reserved	Reserved	Reserved
25	Reserved	Reserved	Reserved
26	Set Remote/Manual	Digital Input	Hold to Ground/Release
27	User-Defined NO Relay 14	Digital Output	Uses Relay RTN 4
28	User-Defined NO Relay 15	Digital Output	Uses Relay RTN 4

Serial Interface

The serial interface enables remote control of the analyzer by a master computer. It is implemented as an RS232 V24 interface and meets all requirements of the AK protocol. A 9-pin male connector at the back of the unit is used to connect a master computer with the following pin assignment:

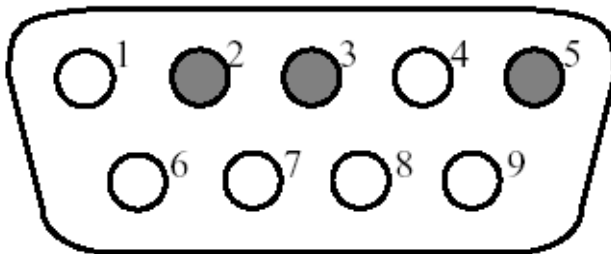

Pin 3 = Txd (transmit)

Pin 2 = Rxd (receive)

Pin 5 = Gnd (ground)

Figure 0-1 Serial Interface

Interface Specifications

Baud Rate:	9600, 4800, 2400, 1200, 600, 300 baud
Data Bits:	7 or 8
Stop Bit:	1 or 2
Don't Care:	1 byte, adjustable (e.g. 32)
Parity:	Even, odd, none
XON/XOFF:	Active or not active
Hand Shake:	No

Ethernet RJ47

If connecting directly to a computer (without using a hub or switch), a crossover cable is required.

AK Protocol

Data Description

Each command begins with STX (Start of Text) in the first byte. The “don’t care” byte can be any ASCII character. Generally, a blank space or an underscore (_) is used to increase readability. The four function bytes represent the AK command. A blank space comes next, followed by K and the channel number. The analyzer is a single-channel device, and because of that, the channel number is usually 0. For delimiting the command parameters from the channel number, another blank follows. This may be followed by command parameters with variable lengths. Every command ends with the ETX (End of Text) character. The Error Status byte does not indicate the real number of errors. For Error Status, use the ASTF command.

Example: Using Windows® HyperTerminal for Serial RS232 Communications with CAI 700LX Series Analyzers requires:

1. HyperTerminal Software
2. Windows PC/Laptop
3. Null Modem Cable

Setup Procedure: run HyperTerminal and configure as shown:

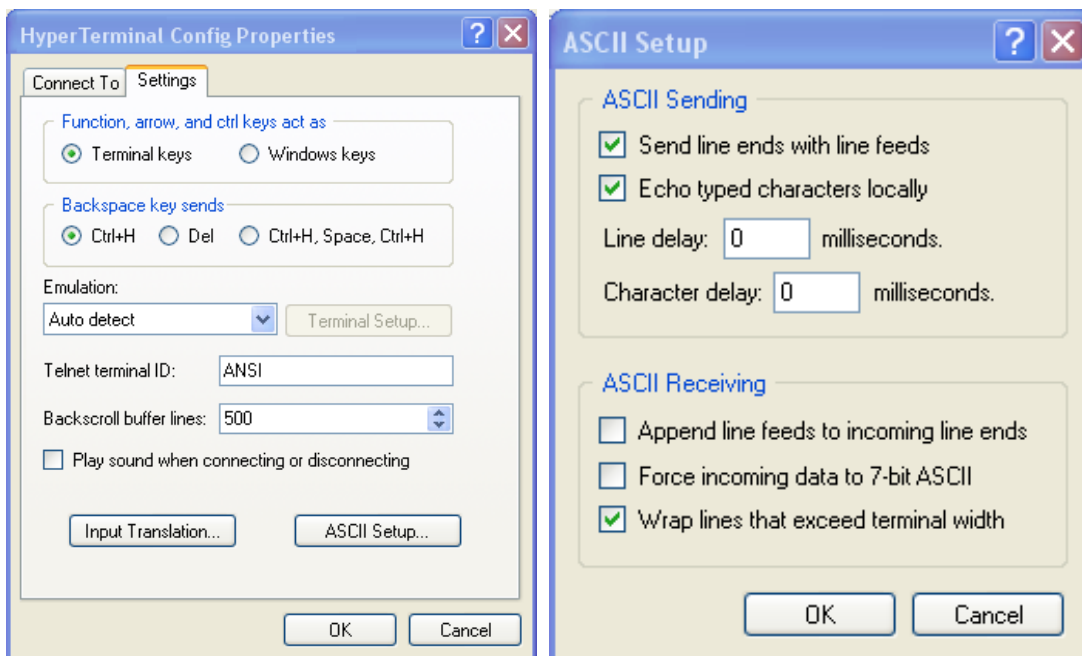

Other similar simple terminal programs should allow similar settings.

When both HyperTerminal and the analyzer are running while connected by the null modem cable, the analyzer will present a menu if sent a non-AK command. This menu can be ignored and AK commands will be acted on by the analyzer. The picture below shows a sequence with the AKON 0 command being sent to the analyzer.

Sending the analyzer characters not framed as AK commands should be prevented as the menu could recognize these characters and cause unplanned changes in configuration.

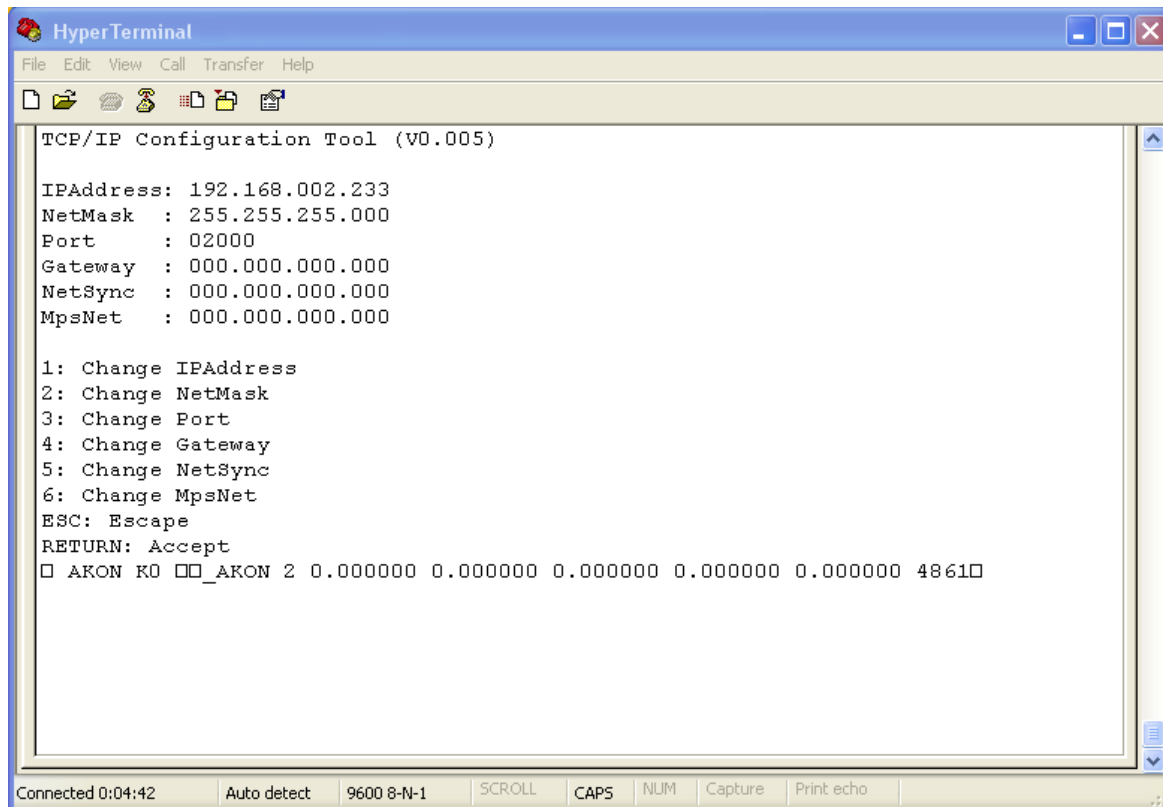

```
HyperTerminal
File Edit View Call Transfer Help
TCP/IP Configuration Tool (V0.005)
IPAddress: 192.168.002.233
NetMask : 255.255.255.000
Port : 02000
Gateway : 000.000.000.000
NetSync : 000.000.000.000
MpsNet : 000.000.000.000

1: Change IPAddress
2: Change NetMask
3: Change Port
4: Change Gateway
5: Change NetSync
6: Change MpsNet
ESC: Escape
RETURN: Accept
[] AKON K0 [] _AKON 2 0.000000 0.000000 0.000000 0.000000 0.000000 4861[]

Connected 0:04:42 Auto detect 9600 8-N-1 SCROLL CAPS NUM Capture Print echo
```

The AK command was typed into HyperTerminal using the following keystrokes:

Hit: Ctrl B (at the same time). This will start the text.

Hit: Ctrl Spacebar (at the same time).

Type: AKON (Function).

Hit: Spacebar.

Type: K0 (Channel #).

Hit: Spacebar.

Hit: Ctrl C (at the same time). This will end the text.

The analyzer will reply with numbers. If you receive ????, bad command.

Instruction Command

Byte	Character	Explanation
1 st Byte	STX	ASCII Code 02
2 nd Byte	Don't Care	Any ASCII code
3 rd Byte	Function Code 1	AK instruction, e.g. ASTF
4 th Byte	Function Code 2	AK instruction, e.g. ASTF
5 th Byte	Function Code 3	AK instruction, e.g. ASTF
6 th Byte	Function Code 4	AK instruction, e.g. ASTF
7 th Byte	Blank	
8 th Byte	K	
9 th Byte	0	
10 th Byte	Blank	
	D	AK instruction parameters; lengths variable
	A	AK instruction parameters; lengths variable
	T	AK instruction parameters; lengths variable
	A	AK instruction parameters; lengths variable
nth Byte	ETX	ASCII Code 03

Example:

<STX>	02H Example: ASTZ K0
Don't Care	Any byte (default 20H)
Function Code	Code 4 bytes long (e.g. ASTZ)
Space 20H	20H
Channel N°	K1 for Channel 1, K2 for Channel 2 and K3 for Channel 3
Space	20H (only if followed by data, otherwise <ETX>)
Data	Data bytes (depending on the command)
<ETX>	03H

Acknowledgement Command

Byte	Character	Explanation
1 st Byte	STX	ASCII Code 02
2 nd Byte	Don't Care	Any ASCII code
3 rd Byte	Function Code 1	Echo of the AK Instruction Command
4 th Byte	Function Code 2	Echo of the AK Instruction Command
5 th Byte	Function Code 3	Echo of the AK Instruction Command
6 th Byte	Function Code 4	Echo of the AK Instruction Command
7 th Byte	Blank	
8 th Byte	K	
9 th Byte	0	
10 th Byte	Blank	
	D	AK acknowledgement parameters; lengths variable
	A	AK acknowledgement parameters; lengths variable
	T	AK acknowledgement parameters; lengths variable
	A	AK acknowledgement parameters; lengths variable
nth Byte	ETX	ASCII Code 03

Example:

<STX>	02H Example: STZ 0 SREM STBY
Don't Care	Adjustable, factory setting 20H
Function Code	Same code as command package (e.g. ASTZ)
Space	20H
Status	0 without error or 1 to 9 when error (see also ASTF command)
Space	20H (only if followed by data, otherwise <ETX>)
Data	Parameter (depending on the command)
<ETX>	03H

Error Handling

It is possible that an unknown instruction is sent, the analyzer is busy with a function that is not the desired one, or an error occurred in the command parameters. The table below provides a summary of all errors that can appear upon any master instruction.

Analyzer's Acknowledgement	Explanation
???? f	Analyzer does not recognize the instruction sent.
xxxx f BS	Analyzer is busy with another function.
xxxx f SE	Syntax error within command parameters or incomplete command.
xxxx f NA	Requested function or data not available.
xxxx f DF	Data error: The kind or number of given parameters not valid.
xxxx f OF	Offline. The analyzer is offline, in local mode. Only inquiry commands and SREM (set analyzer in Remote Mode) are allowed.

NOTES:

1. f is the Error Status byte.
2. xxxx is the function code of the command being sent.

General AK Requirements

1. If the command message contains no error, the Acknowledge message contains the echo of the Function code and the Error Status number (0 to 9).
2. If the transfer was faulty or the function code is unknown, the answer contains four question marks (for example, ???? 0).
3. If the displayed value is not valid, a # symbol is placed in front of the measured value (for example, AIKG 0 #9999).
4. If a control or adjusting command is sent via the serial interface while the device is in Manual mode, it sends an answer like SLIN 0 K0 OF.
5. If a channel does not exist, the answer for control and adjusting commands is, for example, ATEM 0 3 NA. 3 is the number of the subchannel.
6. If the device is busy with a running function (for example, SLIN), every arriving control command is ignored (except SRES and STBY), and the response message is e.g. SMAN 0 BS. If in the SINT mode an additional SINT KO command is received, the integrator is reset to 0 and the integration is restarted.
7. If the command message contains data that the device cannot process (for example, ESYZ K0 ABC), the response message is ESYZ 0 SE. A syntax error is recognized if the data does not match the expected format or if the parameters do not fit the expected size.
8. Numbers are in floating-point format with decimal point. The decimal point can be dropped for integers.
9. If you switch from Remote to Manual, the device will remain in Manual mode until a SREM K0 is received by the control computer. On the display, this mode is indicated by REME (Remote Enable) on the Status line. In Manual mode, query commands via the serial interface are possible at any time.

Abbreviations

Abbreviation	Description
Mn	Measuring Range Number
Mn .. M4	Measuring Range 1 .. 4
w.w .. ZZ.	Numerical Value
x	Number
t	Numeric Integer Value
a0 .. a4	Polynomial Coefficients
s	Status
Yymmdd	Date of Format Year, Month and Day with 2 characters each and no spaces
Hhmmss	Time of Format Hour, Minute and Second with 2 characters each and no spaces

In general, AK commands are subdivided into three classes:

- Scan commands (Axxx)
- Control commands (Sxxx)
- Configuration commands (Exxx)

Scan Commands

AAEG: Verifying Span-Point Deviation During Auto Calibration

Command	Response	Description
_AAEG_Km	_AAEG_s_M1_z.z_da_dr _M2_z.z_da_dr _M3_z.z_da_dr _M4_z.z_da_dr	Verifying deviations of channel m ranges M1 to M4 from span point stored after auto calibration. z.z: Measured value. da: Absolute deviation dr: Relative deviation.

AANG: Verifying Zero-Point Deviation during Auto Calibration

Command	Response	Description
_AANG_Km	_AANG_s_M1_z.z_da_dr _M2_z.z_da_dr _M3_z.z_da_dr _M4_z.z_da_dr	Verifying deviations of channel m ranges M1 to M4 from zero point stored after auto calibration. z.z: Measured value. da: Absolute deviation dr: Relative deviation.

AAOG: Applied Offsets and Gains

Command	Response	Description
_AAOG_Km_	_AAOG_s_M1_z.z_y.y _M2_z.z_y.y _M3_z.z_y.y _M4_z.z_y.y	Offset and Gain of channel m ranges M1 to M4. z.z: Offset y.y: Gain

A CO2: Query CO2 Correction Parameter

Command	Response	Description
_ACO2_Km	_ACO2_s_Ext1_z.z_y.y_x.x_w.w	Gas correction for Channel m Ext1: External 1 voltage input z.z: Offset (the voltage of analog input with no correction gas present) y.y: Min analog input (if analog input is below this value no gas correction will be done) x.x: 1 st order coefficient w.w: 2 nd order coefficient

ADAL: Diagnostic Alarm Limits

Command	Response	Description
_ADAL_K0	_ADAL_s_a1.min_a1.max_... _a16.min_a16max	All alarm limits. 1: Channel 1 Flow 2: Channel 2 Flow 3: Channel 3 Flow 4: External analog 1 5: External analog 2 6: Barometer 7: Analyzer temperature 8: Channel 1 Concentration 1 / Concentration 2 9: Channel 2 Concentration 1 / Concentration 2 10: Channel 3 Concentration 1 / Concentration 2 11: Channel 1 detector temperature 12: Channel 2 detector temperature 13: Channel 3 detector temperature 14: Channel 1 sample EPC voltage % 15: Channel 2 sample EPC voltage % 16: Channel 3 sample EPC voltage %
_ADAL_K0_x	_ADAL_s_x.min_x.max	Alarm limits of x (x = 1 to 16)

ADRU: Pressures and Electronic Pressure Control Valve Voltage

Command	Response	Description
_ADRU_K0	_ADRU_s_z.z_y.y_x.x_w.w _Y.Y_X.X_W.W	Pressures and EPC valve voltages. z.z: Environment pressure. y.y: sample pressure channel 1 x.x: sample pressure channel 2 w.w: sample pressure channel 3 Y.Y: % of Sample EPC Volts for channel 1 X.X: % of Sample EPC Volts for channel 2 W.W: % of Sample EPC Volts for channel 3
_ADRU_Km	_ADRU_s_ % voltage	% of Sample EPC Volts for channel m

ADUF: Flows

Command	Response	Description
_ADUF_K0	_ADUF_s_z.z_y.y_x.x	Sample gas flow of all channels.
_ADUF_Km	_ADUF_s_z.z	Sample gas flow of channel m.

AEMB: Get Measuring Range

Command	Response	Description
_AEMB_K0	_AEMB_s_Mn_Mn_Mn	Current measuring range of all channels.
_AEMB_Km	_AEMB_s_Mn	Current measuring range of channel m.

AENT: Query Calibration Gas Flow Settings (Pumps or Valves)

Command	Response	Description
_AENT_K0	_AENT_s_x	Current calibration gas flow setting. x: 10 = Pump 11 = Valves

AFDA: Auto Calibration Times and Purge Time

Command	Response	Description
_AFDA_Km_SATK	_AFDA_s_z_y_x_w	Auto calibration times in seconds for channel m. z: Purge time. y: Verify time. x: Purge after time. w: Calibrate time. v: Total time.
_AFDA_Km_SSPL	_AFDA_s_z	Purge time will be responded for channel m.

AFGR: Default Factory Polynomial Coefficients

Command	Response	Description
_AFGR_Km_Mn	_AFGR_s_a0_a1_a2_a3_a4	Factory coefficients for channel m range n

AGRD: Operator Level Polynomial Coefficients

Command	Response	Description
_AGRD_Km_Mn	_AGRD_s_a0_a1_a2_a3_a4	Polynomial coefficients of Channel m Range n

AGRW: Max Absolute / Relative Deviation Limits

Command	Response	Description
_AGRW_Km_Mn	_AGRW_s_z.z_y.y	Maximum deviation limits for channel m range n z: Absolute y: Relative

AH2O: Query H2O Correction Parameter

Command	Response	Description
_AH2O_Km	_AH2O_s_Ext2_z.z_y.y_x.x	H2O correction for Channel m. Ext2: External 2 voltage input z.z: Dry (the voltage of analog input with no water present) y.y: 1 st order coefficient x.x: 2 nd order coefficient

AKAK: Calibration Gas Concentrations

Command	Response	Description
_AKAK_Km	_AKAK_s_M1_w.w _M2_x.x _M3_y.y _M4_z.z	All existing calibration gas values for channel m.
_AKAK_Km_Mn	_AKAK_s_Mn_z.z	Calibration gas value of channel m range n.

AKAL: Percent Deviations of Last Accepted Calibration

Command	Response	Description
_AKAL_Km_	_AKAL_s_M1_z.z_y.y_x.x_w.w _M2_z.z_y.y_x.x_w.w _M3_z.z_y.y_x.x_w.w _M4_z.z_y.y_x.x_w.w	Percent Deviation of channel m ranges M1 to M4. z.z: Zero gas relative to last calibration y.y: Zero gas absolute to factory calibration x.x: Span gas relative to last calibration w.w: Span gas absolute to factory calibration

AKEN: Device Identification

Command	Response	Description
_AKEN_K0	_AKEN_s_devicename	Device identification is responded.
_AKEN_K1	_AKEN_s_model	Device Model.
_AKEN_K2	_AKEN_s_serial number	Device Serial Number.
_AKEN_K3	_AKEN_s_sample pressure	Suggested sample input pressure.

AKON: Measured Concentration Value

Command	Response	Description
_AKON_K0	_AKON_s_z.z_y.y_x.x_t	Current Measured Value of all channels. z.z : Channel 1 y.y : Channel 2 x.x : Channel 3 t = Timestamp (1/10 sec.).
_AKON_Km	_AKON_s_z.z_t	z.z : current Measured Value of channel m. t = Timestamp (1/10 sec.).

AMBE: Measuring Range Limit

Command	Response	Description
_AMBE_Km	_AEMB_s_M1_w.w _M2_x.x _M3_y.y _M4_z.z	All existing measuring range limits of channel m.
_AMBE_Km_Mn	_AEMB_s_Mn_z.z	Measuring range limit of channel m range n

AMBU: Upper and Lower Range Switchover Values for Auto Range

Command	Response	Description
_AMBU_Km	_AMBU_s_M1_w.w_W.W _M2_x.x_X.X _M3_y.y_Y.Y _M4_z.z_Z.Z	Lower and upper range switchover values for auto range of channel m.
_AMBU_Km_Mn	_AMBU_s_M1_w.w_W.W	Lower and upper range switchover values for auto range of channel m range n.

APAR: Auto Calibration Tolerance Values

Command	Response	Description
_APAR_Km_SATK	_APAR_s_z.z_y.y_x.x_w.w	Auto calibration tolerance value (%) for channel m. z.z: Range 1 y.y: Range 2 x.x: Range 3 w.w: Range 4

ARAW: Raw Detector Volts

Command	Response	Description
_ARAW_K0	_ARAW_s_z.z_y.y_x.x_t	Raw Detector Volts for all channels. z.z : Channel 1 y.y : Channel 2 x.x : Channel 3 t = Timestamp (1/10 sec.)
_ARAW_Km	_ARAW_s_z.z_t	Raw Detector Volts of channel m. t = Timestamp (1/10 sec.)

ARMU: Raw Engineering Value

Command	Response	Description
_ARMU_K0	_ARMU_s_z.z_y.y_x.x_t	Raw Engineering Value before linearization, offset and span correction for all channels. These are the values used to calculate the polynomial coefficients. t = Timestamp (1/10 sec.).
_ARMU_Km	_ARMU_s_z.z_t	Raw Engineering Value before linearization, offset and span correction for Channel m. These are the values used to calculate the polynomial coefficients. t = Timestamp (1/10 sec.).

ASTF: Error Status

Command	Response	Description
_ASTF_K0	_ASTF_s_f1_f2_f3...f32	<p>Current error numbers are responded.</p> <p>1: Check flow channel 1</p> <p>2: Check flow channel2</p> <p>3: Check flow channel 3</p> <p>4: Check external analog 1</p> <p>5: Check external analog 2</p> <p>6: Check barometer</p> <p>7: Check analyzer temperature</p> <p>8: Channel 1 is not calibrated</p> <p>9: Channel 2 is not calibrated</p> <p>10: Channel 3 is not calibrated</p> <p>11: Channel 1 concentration 1 warning</p> <p>12: Channel 2 concentration 1 warning</p> <p>13: Channel 3 concentration 1 warning</p> <p>14: Channel 1 concentration 2 warning</p> <p>15: Channel 2 concentration 2 warning</p> <p>16 : Channel 3 concentration 2 warning</p> <p>17: Check channel 1 temperature</p> <p>18: Check channel 2 temperature</p> <p>19: Check channel 3 temperature</p> <p>20: Check channel 1 EPC voltage</p> <p>21: Check channel 2 EPC voltage</p> <p>22: Check channel 3 EPC voltage</p> <p>23: Channel 1 range overflow</p> <p>24: Channel 2 range overflow</p> <p>25: Channel 3 range overflow</p> <p>26: Channel 1 ADC range overflow</p> <p>27: Channel 2 ADC range overflow</p> <p>28: Channel 3 ADC range overflow</p> <p>29: Channel 1 ADC range underflow</p> <p>30: Channel 2 ADC range underflow</p>

ASTF: Error Status **Continued**

Command	Response	Description
_ASTF_K0	_ASTF_s_f1_f2_f3_...f32	Current error numbers are responded. 31: Channel 3 ADC range underflow 32: Dummy Text for RTC-Time

ASTZ: Normal Device Status

Command	Response	Description
_ASTZ_K0	_ASTZ_s_K1_State 1_State 2_State 3 _K2_State 1_State 2_State 3 _K3_State 1_State 2_State 3	Device statuses for all channels.
_ASTZ_Km	_ASTZ_s_Km_State 1_State 2_State 3	Device statuses for channel m.
Possible States	Response	Description
State 1	SREM SMAN	Remote Manual
State 2	STBY SPAU SMGA SNGA SEGA SATK SNGA SATK SEGA	Standby Pause Measuring gas Zero gas Span gas Zero gas during auto cal span gas during auto cal
State 3	SARE SARA	Auto range On Auto range Off

ASYZ: Respond System Time

Command	Response	Description
_ASYZ_K0	_ASYZ_s_yymmdd_hhmmss	System Time. yymmdd: year, month, day hhmmss: hour, minute, second (each 2 characters wide, no spaces)

ATCP: Query TCP/IP Settings

Command	Response	Description
_ATCP_K0	_ATCP_s_ <i>zzz.zzz.zzz.zzz</i> <i>_yyy.yyy.yyy.yyy</i> <i>_xxxx</i>	TCP/IP settings. <i>zzz</i> : TCP/IP Address <i>yyy</i> : TCP/IP subnet mask <i>xxxx</i> : TCP/IP port

ATEM: Temperatures

Command	Response	Description
_ATEM_K0	_ATEM_s_ <i>z.z_y.y_x.x_w.w</i>	Temperatures. <i>zz</i> : Analyzer Temperature. <i>yy</i> : Detector 1 Temperature. <i>xx</i> : Detector 2 Temperature. <i>ww</i> : Detector 3 Temperature.
_ATEM_Km	_ATEM_s_ <i>zz</i>	Detector temperature of channel m.

AT90: Respond Low-pass Filter Time

Command	Response	Description
_AT90_K0	_AT90_s_ <i>Ch1t_Ch2t_Ch3t</i>	Low-pass filter time in seconds for all channels. <i>t</i> = filter time in seconds
_AT90_Km	_AT90_s_ <i>t</i>	Low-pass filter time in seconds for channel m.

AUDP: Query UDP Data Streaming Parameter

Command	Response	Description
_AUDP_K0	_AUDP_s_<UDPPort> <DataFrequency>_ [<Mode>] _ [<UDP_IP>]_[Data]_[On/Off]	UDP port: opened for connection Data Frequency: transmission frequency of the data in Hz Mode: A: ASCII Mode UDP_IP: alternative IP address open for the UDP connection when it should use the IP connected to the TCP/IP client. Data: Commands to be streamed over UDP. On/Off: 0. Off 1. On

AVER: Query Software Version

Command	Response	Description
_AVER_K0	_AVER_s_3MAIN_Z_mm.dd.yyyy_ 3USER_Y_mm.dd.yyyy_OSMSR_ X_dd.mm.yyyy	Z: 3MAIN version build number Y: 3USER version build number X: OSMSR version build number dd: Day mm: Month yyyy: Year

Control Commands

SARA: Auto Range Off

Command	Response	Description
_SARA_K0	_SARA_s	Set auto range off for all channels.
_SARA_Km	_SARA_s	Set auto range off for channel m.

SARE: Auto Range On

Command	Response	Description
_SARE_K0	_SARE_s	Set auto range on for all channels.
_SARE_Km	_SARE_s	Set auto range on for channel m.

SATK: Start Automatic Calibration

Command	Response	Description
_SATK_Km	_SATK_s	Start automatic calibration of channel m for current range.
_SATK_Km_Mn	_SATK_s	Start automatic calibration of channel m for range n.

SEGA: Open Valve for Span Gas Calibration

Command	Response	Description
_SEGA_K0	_SEGA_s	Sets all channels to Span Calibration mode.
_SEGA_Km	_SEGA_s	Sets channel m to Span Calibration mode.
_SEGA_Km_Mn	_SEGA_s	Open channel m to Span Calibration mode Range n.

SEKA: Saves Measured Value as New Span Value

Command	Response	Description
_SEKA_K0	_SEKA_s	Saves measured value of current range as gain for all channels if span mode is active.
_SEKA_Km	_SEKA_s	Saves measured value of current range as gain for channel m if span mode is active.

SEMB: Set Measuring Range

Command	Response	Description
_SEMB_Km_Mn	_SEMB_s	Set measuring range of channel m to range n. Auto range will be disabled.

SENT: Set Calibration Gas Flow (Pumps or Valves)

Command	Response	Description
_SENT_K0_X	_SENT_s	X: 10 = Pump 11 = Valves

SFGR: Reset Calibration Settings to factory defaults

Command	Response	Description
_SFGR_Km	_SFGR_s	Resets factory polynomials, offsets and gains to the default values for channel m.

SMAN: Manual Control to Control Device Manually

Command	Response	Description
_SMAN_K0	_SMAN_s	Set analyzer in manual mode.

SMGA: Start Measuring Mode (Turns On Pump if Fitted)

Command	Response	Description
_SMGA_K0	_SMGA_s	Sets all channels to Measure mode.
_SMGA_Km	_SMGA_s	Sets channel m to Measure mode.

SNGA: Open Valve for Zero Gas Calibration

Command	Response	Description
_SNGA_K0	_SNGA_s	Sets all channels to Zero Calibration mode.
_SNGA_Km	_SNGA_s	Sets channel m to Zero Calibration mode.
_SNGA_Km_Mn	_SNGA_s	Sets channel m to Zero Calibration mode for Range n.

SNKA: Saves Measured Value as New Zero Offset

Command	Response	Description
_SNKA_K0	_SNKA_s	Saves Measured values of the current range as offsets for all channels if zero modes are active.
_SNKA_Km	_SNKA_s	Saves measured value of the current range as offset for all channel m if zero mode is active.

SPAU: Pause

Command	Response	Description
_SPAU_K0	_SPAU_s	Sets pause mode

SREM: Remote Mode for AK Commands

Command	Response	Description
_SREM_K0	_SREM_s	Set analyzer in Remote mode.

SRES: Reset

Command	Response	Description
_SRES_K0	_SRES_s	Reset

SSPL: Purge Analyzer with Zero Gas

Command	Response	Description
_SSPL_K0	_SSPL_s	Open zero gas valves and purge all channels.

STBY: Standby

Command	Response	Description
_STBY_K0	_STBY_s	Standby mode
_STBY_Km	_STBY_s	Standby mode for channel m

SUDP: Start/Stop UDP Data Streaming

Command	Response	Description
_SUDP_K0_ON	_SUDP_s	Start data streaming via the UDP channel. Configure the UDP channel using the EUDP command before starting.
_SUDP_K0_OFF	_SUDP_s	Stop streaming via the UDP channel.

SVZS: Reset Offset to 0 and Gain to 1

Command	Response	Description
_SVZS_K0	_SVZS_s	Sets all range offsets to 0 and all gains to 1.
_SVZS_Km	_SVZS_s	Sets all range offsets to 0 and gains to 1 for channel m.

Configuration Commands

ECO2: Set CO2 Correction Factor s

Command	Response	Description
<code>_ECO2_Km_z.z_y.y_x.x_w.w</code>	<code>_ECO2_s</code>	Set CO2 correction factors for channel m. z.z = Offset y.y = Minimum analog input x.x = 1 st order coefficient w.w = 2 nd order coefficient

EDAL: Set Diagnostic Alarm Limits

Command	Response	Description
<code>_EDAL_K0_al.min_</code> <code>a1.max_..._a16max</code>	<code>_EDAL_s</code>	Set all alarm limits. 1: Channel 1 Flow 2: Channel 2 Flow 3: Channel 3 Flow 4: External analog 1 5: External analog 2 6: Barometer 7: Analyzer temperature 8: Channel 1 Concentration 1 / Concentration 2 9: Channel 2 Concentration 1 / Concentration 2 10: Channel 3 Concentration 1 / Concentration 2

EDAL: Set Diagnostic Alarm Limits Continued

Command	Response	Description
<u>_EDAL_K0_ai.min_</u> <u>a1.max_..._a16max</u>	<u>_EDAL_s</u>	Set all alarm limits. 11: Channel 1 detector temperature 12: Channel 2 detector temperature 13: Channel 3 detector temperature 14: Channel 1 sample EPC voltage % 15: Channel 2 sample EPC voltage % 16: Channel 3 sample EPC voltage %
<u>_EDAL_K0_x_</u> <u>x.min_xmax</u>	<u>_EDAL_s</u>	Set alarm limit of x.

EFDA: Set Auto Calibration and Purge Times

Command	Response	Description
<u>_EFDA_Km_SATK_</u> <u>z_y_x</u>	<u>_EFDA_s</u>	Set auto calibration times for channel m in seconds. z: Purge time y: Verify time x: Purge after
<u>_EFDA_K0_</u> <u>SSPL_z</u>	<u>_EFDA_s</u>	Set analyzer purge time to z seconds.

EGRD: Set the User Level's Range Polynomial Coefficients

Command	Response	Description
<u>_EGRD_Km_Mn_</u> <u>A0_a1_a2_a3_a4</u>	<u>_EGRD_s</u>	Set the user level's polynomial coefficients for channel m range n.

EGRW: Set Maximum Absolute and Relative Deviation Limits

Command	Response	Description
<u>_EGRW_Km_Mn_z_y</u>	<u>_EGRW_s</u>	Sets absolute and relative deviations for channel m range n in %. z: Absolute y: Relative

EH2O: Set H2O Correction Factors

Command	Response	Description
_EH2O_Km_z.z_y.y_x.x	_EH2O_s	Set H2O correction factors for channel m. z.z = Dry yy = 1 st order coefficient x.x = 2 nd order coefficient

EKAK: Set the Four Span Gas Concentration Values

Command	Response	Description
_EKAK_Km_M1_ w.w_M2_x.x_M3_ y.y_M4_z.z	_EKAK_s	Set the span gas values for channel m.

EKEN: Set New Device Identification Name

Command	Response	Description
_EKEN_K0_new device name	_EKEN_s	Set new device identification name. Maximum length 40 characters

NOTE: To change device identification, you must first rename the device to "RESET".
Now a name up to 40 letters can be given.

NOTE: The device name must not have any blanks between, f.e. "CAI NDIR" is not allowed. You can use underline, i.e. "CAI_NDIR".

EMBE: Set the Four Measuring Range Full Scale Limits

Command	Response	Description
_EMBE_Km_M1_ w.w_M2_x.x_M3_ y.y_M4_z.z	_EMBE_s	Set the full scale range limits for channel m.

EMBU: Set the Upper and Lower Range Switch Values for Auto Range

Command	Response	Description
_EMBU_Km_M1_ w.w_W.W_M2_x.x_ X.X_M3_y.y_Y.Y_ M4_z.z_Z.Z	_EMBU_s	Set the lower and upper range switch values for channel m.

EPAR: Set Auto Calibration Tolerance Values

Command	Response	Description
_EPAR_Km_SATK_ z.z_y.y_x.x_w.w	_EPAR_s	Auto calibration tolerance value (%) for channel m. z.z = Range 1 y.y = Range 2 x.x = Range 3 w.w = Range 4

ESYZ: Set System Time

Command	Response	Description
_ESYZ_K0_ yymmdd_hhmmss	_ESYZ_s	Set system time: yymmdd: year, month, day (each 2 characters wide, no spaces) hhmmss: hour, minutes, seconds (each 2 characters, no spaces)

ETCP: Set TCP/IP Parameters

Command	Response	Description
_ETCP_K0_ zzz.zzz.zzz.zzz_ yyy.yyy.yyy.yyy_xxxx	_ETCP_s	Set TCP/IP Parameters zzz = TCP/IP address yyy = TCP/IP subnet mask xxxx = TCP/IP port All changes take effect after next Power On cycle.

ET90: Set Lowpass Filter Time

Command	Response	Description
_ET90_Km_t	_ET90_s	Set lowpass filter time for channel m in seconds. t = filter time

EUDP: Set TCP/IP Data Streaming Parameters

Command	Response	Description
_EUDP_K0_<UDPPort>_ <DataFrequency>_ [<Mode>]_[<UDP_IP>]_[Data]	_EUDP_s	Configure a UDP channel for data streaming of the measuring values via Ethernet UDP. Port: port for opening the UDP connection. Data Frequency: Frequency for transmitting the data in Hz. Mode: A: ASCII Mode (optional). UDP_IP: Alternative IP address for opening the UDP connection when it should not be using the IP of the connected TCP/IP client (optional).

Data Format

DATA is any number of AK commands delimited by a semicolon (;). Replace underscore (_) in the AK command with a space.

If data is given, UDP_IP has to be set to a legal IP address or a hyphen (-) if default access should be used.

If data is omitted, "AKON K0" is used as default streaming data.

Format of the Streaming Data via UDP

ASCII Mode:

The measuring values will be sent with ASCII signs. The format is <sequence number> <data>

The sequence number will be incremented with every data packet that is sent.

<data> is the AK four-character code followed by the answer. See corresponding AK command description.

Example

Sending “EUDP K0 7001 2 A – AKON_KO;ADUF_K0” will give the following streaming result:

“123 AKON 4.07 901.33 22.50 3481639460 ADUF 4.30 4.59 4.45”, where 123 is the sequence number.

Modbus Protocol

Modbus on TCP/IP Application Data Unit

MBAP Description

This section describes the encapsulation of a Modbus request or a response when it is carried on a Modbus TCP/IP network.

A dedicated header, called the MBAP (Modbus Application Protocol) header, is used on TCP/IP to identify the Modbus Application Data Unit. This header provides some essential differences compared to the Modbus RTU application data unit used on the serial line:

1. The Modbus Slave Address field usually used on a Modbus Serial Line is replaced by a single-byte Unit Identifier within the MBAP Header. The Unit Identifier is used to communicate via devices such as bridges, routers and gateways that use a single IP address to support multiple independent Modbus end units.
2. All Modbus requests and responses are designed to allow the recipient to verify that a message is finished. For function codes on which the Modbus PDU has a fixed length, the function code alone is sufficient. For function codes carrying a variable amount of data in the request or response, the data field includes a byte count.
3. When Modbus is carried over TCP, additional length information is carried in the MBAP header to allow the recipient to recognize message boundaries even if the message has been split into multiple packets for transmission. The existence of explicit and implicit length rules and use of a CRC-32 error check code (on Ethernet) virtually eliminate the possibility of undetected corruption to a request or response message.

MBAP Header Description

The MBAP Header contains the following fields:

Field	Length	Description
Transaction Identifier	2 Bytes	Identification of a Modbus request / Response transaction
Protocol Identifier	2 Bytes	0 = Modbus
Length	2 Bytes	Number of following bytes
Unit Identifier	1 Byte	Identification of a remote slave connected on a serial line or on other buses

The header is seven bytes long:

- **Transaction Identifier** – Used for transaction pairing, the Modbus server copies in the response the transaction identifier of the request.
- **Protocol Identifier** – Used for intra-system multiplexing. The Modbus protocol is identified by the value 0.
- **Length** - The Length field is a byte count of the following fields, including the Unit Identifier and Data fields.
- **Unit Identifier** – This field is used for intra-system routing. It is typically used to communicate to a Modbus+ or a Modbus serial line slave through a gateway between an Ethernet TCP-IP network and a Modbus serial line. This field is set by the Modbus client in the request and must be returned with the same value in the response by the server.

All Modbus/TCP ADU are sent via TCP to Registered Port 502.

The different fields are encoded in Big-endian. The 700LX NDIR/O₂ Analyzer uses only the Length bytes from the MBAP section.

Modbus Command Function Codes

Code 01

This function code is used to read from 1 to 2000 contiguous status bits in a remote device.

The requesting remote device specifies the starting address, including the address of the first bit specified and the number of bits. The device bits are addressed starting at zero. Therefore, bits numbered 1-16 are addressed as 0-15.

The bits in the response message are packed as one bit per bit of the data field. Status is indicated as 1 = ON and 0 = OFF. The LSB of the first data byte contains the output addressed in the query. The other bits follow toward the high order end of this byte, and from low order to high order in subsequent bytes.

If the returned output quantity is not a multiple of eight, the remaining bits in the final data byte will be padded with zeros (toward the high order end of the byte). The Byte Count field specifies the quantity of complete bytes of data.

Request

Function Code	1 Byte	0x01
Starting Address	2 Bytes	0x0000 to 0xFFFF
Quantity of Bits	2 Bytes	1 to 2000 (0x7D0)

Response

Function Code	1 Byte	0x01
Byte Count	1 Byte	N*
Bit Status	n Byte	n = N or N+1

*N = Quantity of Outputs / 8, if the remainder is different of 0 \Rightarrow N = N+1.

Error

Function Code	1 Byte	Function code + 0x80
Exception Code	1 Byte	01 or 02 or 03 or 04

Here is an example of a request to read discrete outputs 20–38:

Request		Response	
<i>Field Name</i>	<i>(Hex)</i>	<i>Field Name</i>	<i>(Hex)</i>
Function	01	Function	01
Starting Address Hi	00	Byte Count	03
Starting Address Lo	13	Status of Outputs 27-20	CD
Quantity of Outputs Hi	00	Status of Outputs 35-28	6B
Quantity of Outputs Lo	13	Status of Outputs 38-36	05

The status of outputs 27–20 is shown as the byte value CD hex, or binary 1100 1101. Output 27 is the MSB of this byte, and output 20 is the LSB.

By convention, bits within a byte are shown with the MSB to the left and the LSB to the right. Thus the outputs in the first byte are 27-20 from left to right. The next byte has outputs 35-28 left to right. As the bits are transmitted serially, they flow from LSB to MSB: 20 . . . 27, 28 . . . 35, and so on.

In the last data byte, the status of outputs 38-36 is shown as the byte value 05 hex, or binary 0000 0101. Output 38 is in the sixth bit position from the left, and output 36 is the LSB of this byte. The five remaining high-order bits are zero filled.

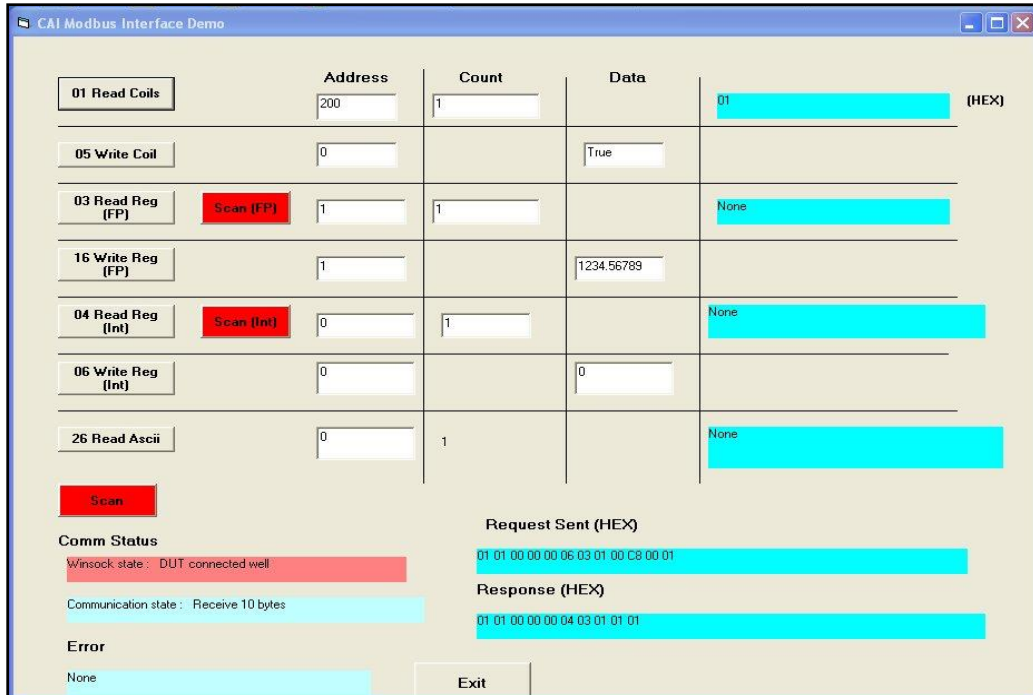

Command 01, Read Coil 200 Count 1. Result = 01.

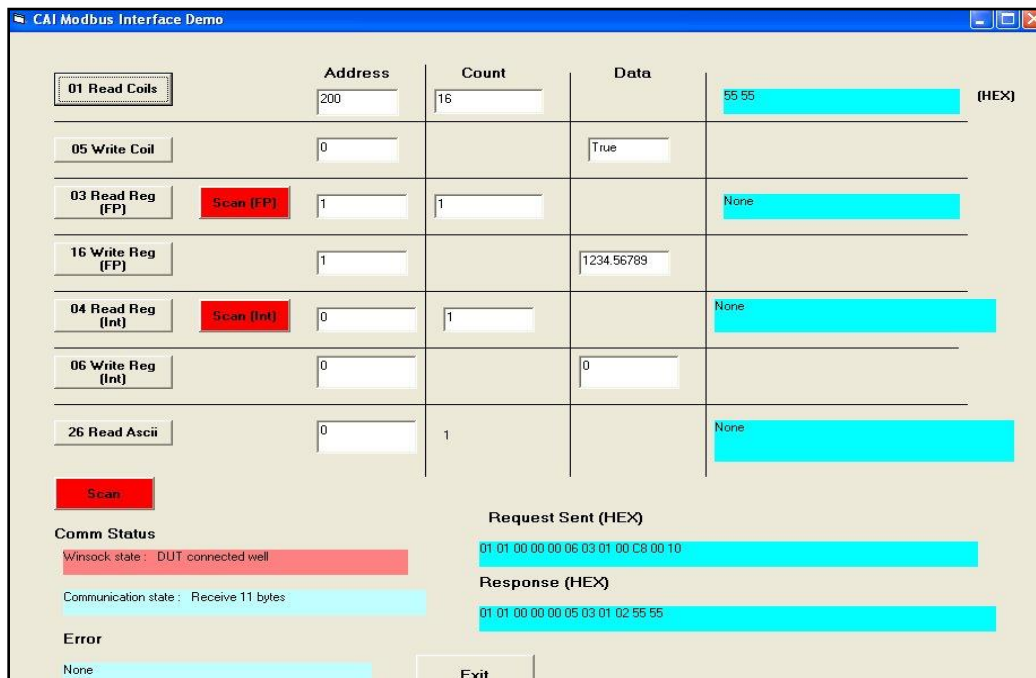

Command 01, Read Coil 200 Count 16. Result = 55 55 hex.

Code 03

This command has been modified to read floating-point numbers in 32-bit IEEE format.

This function code is used to read the contents of a contiguous block of floating-point registers in a remote device. The Request PDU specifies the starting register address and the number of registers. In the PDU, registers are addressed starting at zero. Therefore, registers numbered 1-16 are addressed as 0-15.

The register data in the response message are packed as four bytes per register, with the binary contents right justified within each byte. For each register, the first byte contains the high-order bits and the second byte contains the low-order bits.

Request

Function Code	1 Byte	0x03
Starting Address	2 Bytes	0x0000 to 0xFFFF
Quantity of Registers	2 Bytes	2 to 124 (0x7C)

Response

Function Code	1 Byte	0x03
Byte Count	1 Byte	2 x N*
Register Value	N* x 2 Bytes	

*N = Quantity of Registers

Here is an example of a request to read Register 0:

Request		Response	
<i>Field Name</i>	<i>(Hex)</i>	<i>Field Name</i>	<i>(Hex)</i>
Function	03	Function	03
Starting Address Hi	00	Byte Count	04
Starting Address Lo	00	Register Value Hi (1)	52
Number of Registers Hi	00	Register Value Lo (1)	2C
Number of Registers Lo	02	Register Value Hi (0)	44
		Register Value Lo (0)	9A

The contents of Register 0 are shown as the four byte values of 44 9A, 52 2C hex, or 1234.56789 decimal.

Here is an example of a request to read Register 40201:

Request		Response	
<i>Field Name</i>	<i>(Hex)</i>	<i>Field Name</i>	<i>(Hex)</i>
Function	03	Function	03
Starting Address Hi	9D	Byte Count	04
Starting Address Lo	09	Register Value Hi (40202)	33
Number of Registers Hi	00	Register Value Lo (40201)	33
Number of Registers Lo	02	Register Value Hi (40201)	41
		Register Value Lo (40201)	8F

The contents of register 40201 are shown as the four byte values of 41 8F 33 33 hex, or 17.9 decimal.

Here is an example of a request to read three registers starting at 40201:

Request		Response	
<i>Field Name</i>	<i>(Hex)</i>	<i>Field Name</i>	<i>(Hex)</i>
Function	03	Function	03
Starting Address Hi	9D	Byte Count	0C
Starting Address Lo	09	Register Value Hi (40202)	33
Number of Registers Hi	00	Register Value Lo (40201)	33
Number of Registers Lo	06	Register Value Hi (40201)	41
		Register Value Lo (40201)	8F
		Register Value Hi (40204)	33
		Register Value Lo (40204)	33
		Register Value Hi (40203)	41
		Register Value Lo (40203)	8F
		Register Value Hi (40206)	00
		Register Value Lo (40206)	00
		Register Value Hi (40205)	00
		Register Value Lo (40205)	00

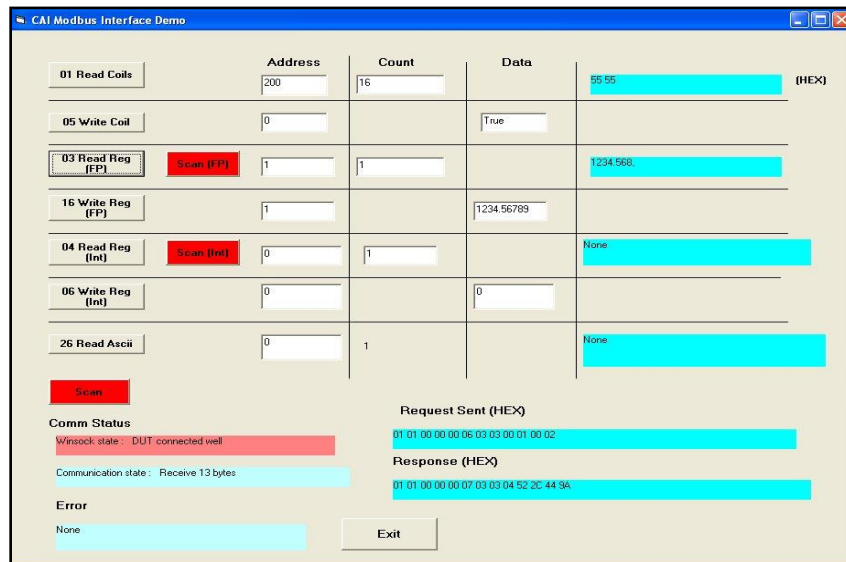

Command 03, Read Floating Point value from Address 1. Result = 1234.56789.

Command	Address	Count	Data
01 Read Coils	200	16	55 55 (HEX)
05 Write Coil	0		True
03 Read Reg (FP)	1	4	1234.568, 0.0, -1234.568, 10000.0
16 Write Reg (FP)	1		1234.56789
04 Read Reg (Int)	0	1	None
06 Write Reg (Int)	0		0
26 Read Ascii	0	1	None

Comm Status
 Winsock state : DUT connected well
 Communication state : Receive 25 bytes

Request Sent (HEX)
 01 01 00 00 00 06 03 03 00 01 00 08

Response (HEX)
 01 01 00 00 00 13 03 03 10 52 2C 44 9A 00 00 00 00 52 2C C4 9A 40 00 46 1C

Error
 None

Buttons: Scan, Exit

Command 03, Read four Floating Point values starting at Address 1.

Result = 1234.56789, 0.0 -1234.568, 10000.

Code 04

This function code is used to read from 1 to 125 contiguous input registers in a remote device. The Request PDU specifies the starting register address and the number of registers. In the PDU, registers are addressed starting at zero. Therefore input registers numbered 1-16 are addressed as 0-15.

The register data in the response message are packed as two bytes per register, with the binary contents right justified within each byte. For each register, the first byte contains the high-order bits and the second byte contains the low-order bits.

Request

Function Code	1 Byte	0x04
Starting Address	2 Bytes	0x0000 to 0xFFFF
Quantity of Input Registers	2 Bytes	0x0001 to 0x007D

Response

Function Code	1 Byte	0x04
Byte Count	1 Byte	2 x N*
Input Registers	N* x 2 Bytes	

*N = Quantity of Registers

Here is an example of a request to read Input Register 8:

Request		Response	
Field Name	(Hex)	Field Name	(Hex)
Function	04	Function	04
Starting Address Hi	00	Byte Count	02
Starting Address Lo	08	Input Register 9 Hi	00
Quantity of Input Registers Hi	00	Input Register 9 Lo	0A
Quantity of Input Registers Lo	01		

The contents of Input Register 8 are shown as the two-byte values of 00 0A hex, or 10 decimal.

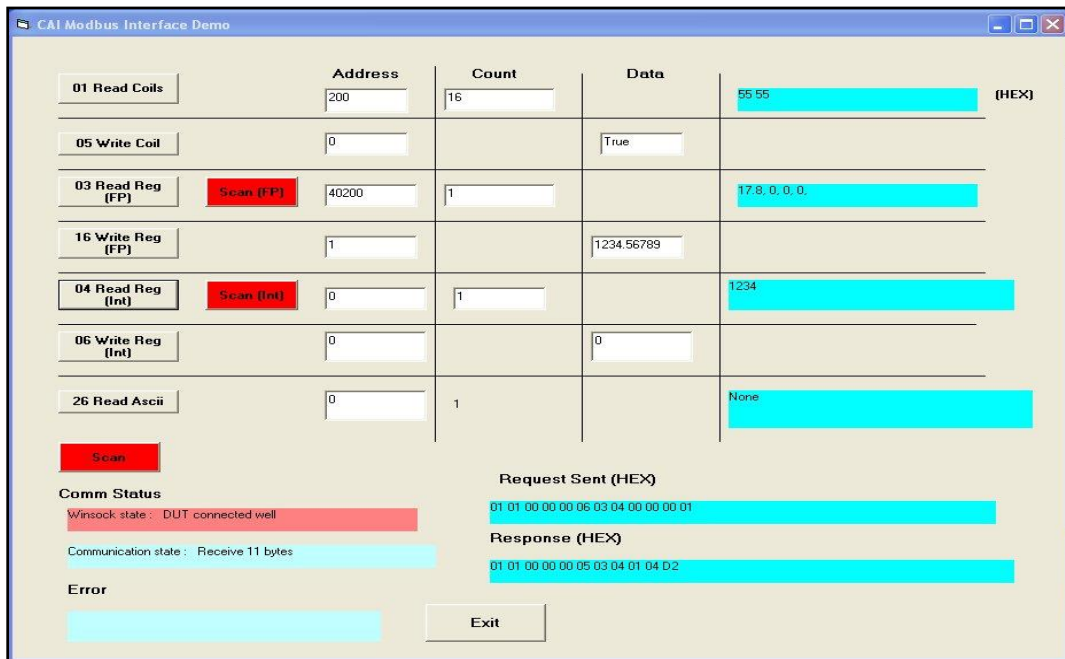

Command 04, Read one integer value from Address 0. Result = 1234.

Code 05

This function code is used to write a single output to either ON or OFF in a remote device.

The requested ON/OFF state is specified by a constant in the request data field. A value of FF 00 hex requests the output to be ON. A value of 00 00 requests it to be OFF. All other values are illegal and will not affect the output.

The Request PDU specifies the address of the bit to be forced. Bits are addressed starting at zero. Therefore the bit numbered 1 is addressed as 0. The requested ON/OFF state is specified by a constant in the Bit Value field. A value of 0xFF00 requests the bit to be ON. A value of 0x0000 requests the bit to be off. All other values are illegal and will not affect the bit.

The normal response is an echo of the request, returned after the bit state has been written.

Request

Function Code	1 Byte	0x05
Output Address	2 Bytes	0x0000 to 0xFFFF
Output Value	2 Bytes	0x0000 to 0xFF00

Response

Function Code	1 Byte	0x05
Output Address	2 Bytes	0x0000 to 0xFFFF
Input Registers	2 Bytes	0x0000 to 0xFF00

Here is an example of a request to write bit 173 ON:

Request		Response	
Field Name	(Hex)	Field Name	(Hex)
Function	05	Function	05
Output Address Hi	00	Output Address Hi	00
Output Address Lo	AC	Output Address Lo	AC
Output Value Hi	FF	Output Value Hi	FF
Output Value Lo	00	Output Value Lo	00

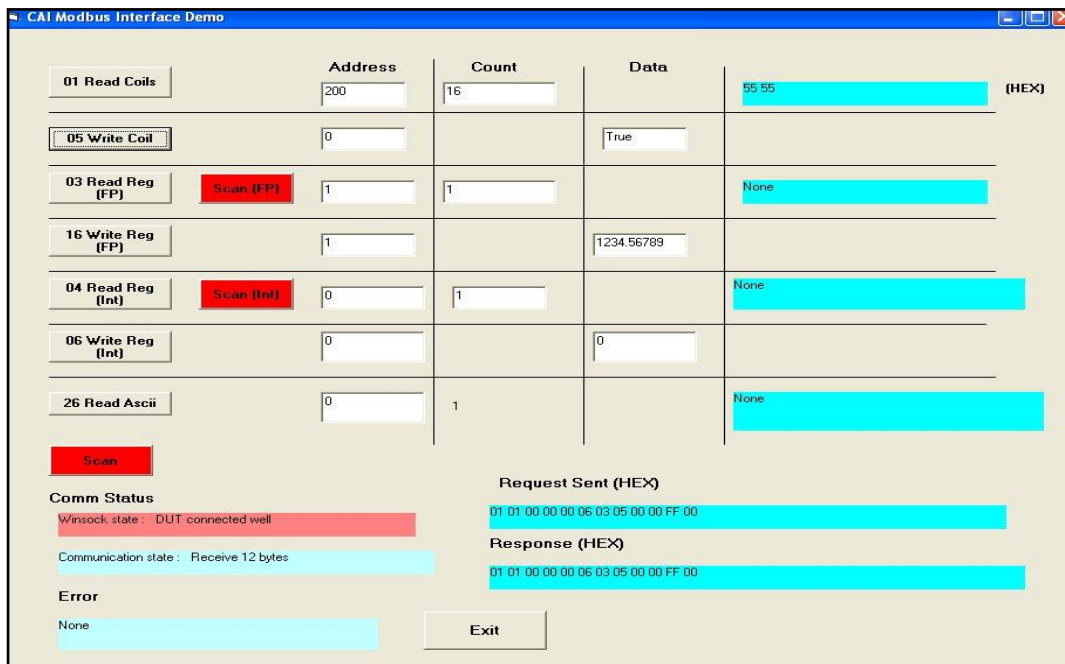

Command 05, Write a single-bit value (true) to Address 0.

Code 06

This function code is used to write a single holding register in a remote device. The Request PDU specifies the address of the register to be written. Registers are addressed starting at zero. Therefore the register numbered 1 is addressed as 0.

The normal response is an echo of the request, returned after the register contents have been written.

Request

Function Code	1 Byte	0x06
Output Address	2 Bytes	0x0000 to 0xFFFF
Output Value	2 Bytes	0x0000 to 0xFFFF

Response

Function Code	1 Byte	0x06
Output Address	2 Bytes	0x0000 to 0xFFFF
Input Registers	2 Bytes	0x0000 to 0xFF00

Error

Error Code	1 Byte	0x86
Exception Code	1 Byte	01 or 02 or 03 or 04

Here is an example of a request to write Register 1 to 00 03 hex:

Request		Response	
Field Name	(Hex)	Field Name	(Hex)
Function	06	Function	06
Register Address Hi	00	Register Address Hi	00
Register Address Lo	01	Register Address Lo	01
Register Value Hi	00	Register Value Hi	00
Register Value Lo	03	Register Value Lo	03

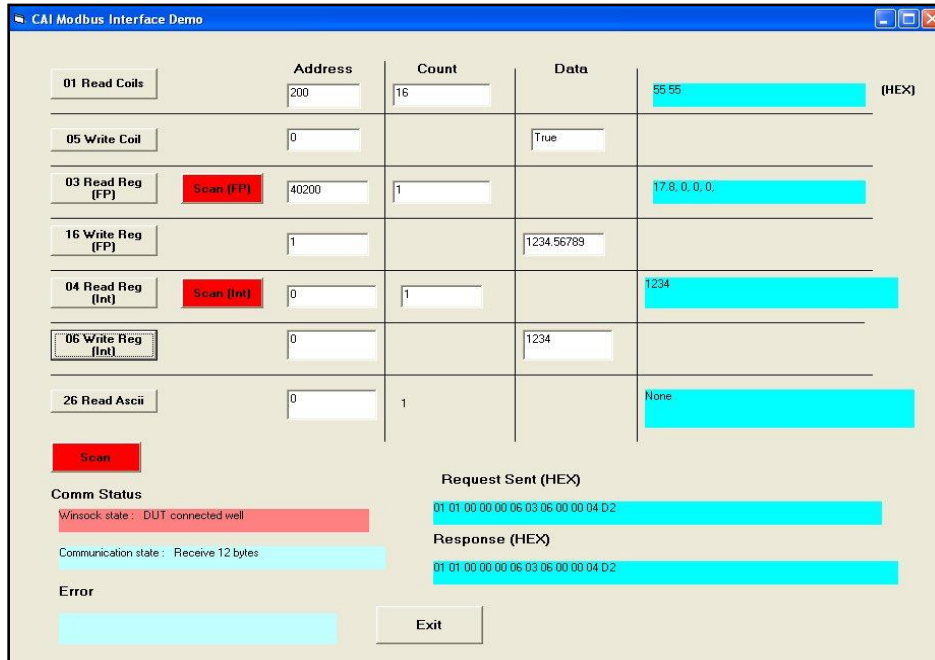

Command 06, write one holding register.

Code 16

This function code is used to write a single floating point register to a remote device.

The requested written values are specified in the request data field. Data is packed as four bytes per register. The normal response returns the function code, starting address and quantity of registers written. *The analyzer ignores the numbers in the register and byte count and expects four data bytes.*

Request

Function Code	1 Byte	0x10
Starting Address	2 Bytes	0x0000 to 0xFFFF
Quantity of Registers	2 Bytes	2
Byte Count	1 Byte	4
Registers Value	4 Bytes	value

Response

Function Code	1 Byte	0x10
Starting Address	2 Bytes	0x0000 to 0xFFFF
Quantity of Registers	2 Bytes	2

Error

Error Code	1 Byte	0x90
Exception Code	1 Byte	01 or 02 or 03 or 04

Here is an example of a request to write two registers starting at 2 to 00 0A and 01 02 hex:

Request		Response	
Field Name	(Hex)	Field Name	(Hex)
Function	10	Function	10
Starting Address Hi	00	Starting Address Hi	00
Starting Address Lo	01	Starting Address Lo	01
Quantity of Registers Hi	00	Quantity of Registers Hi	00
Quantity of Registers Lo	02	Quantity of Registers Lo	02
Byte Count	04		
Registers Value Hi	00		
Registers Value Lo	0A		
Registers Value Hi	01		
Registers Value Lo	02		

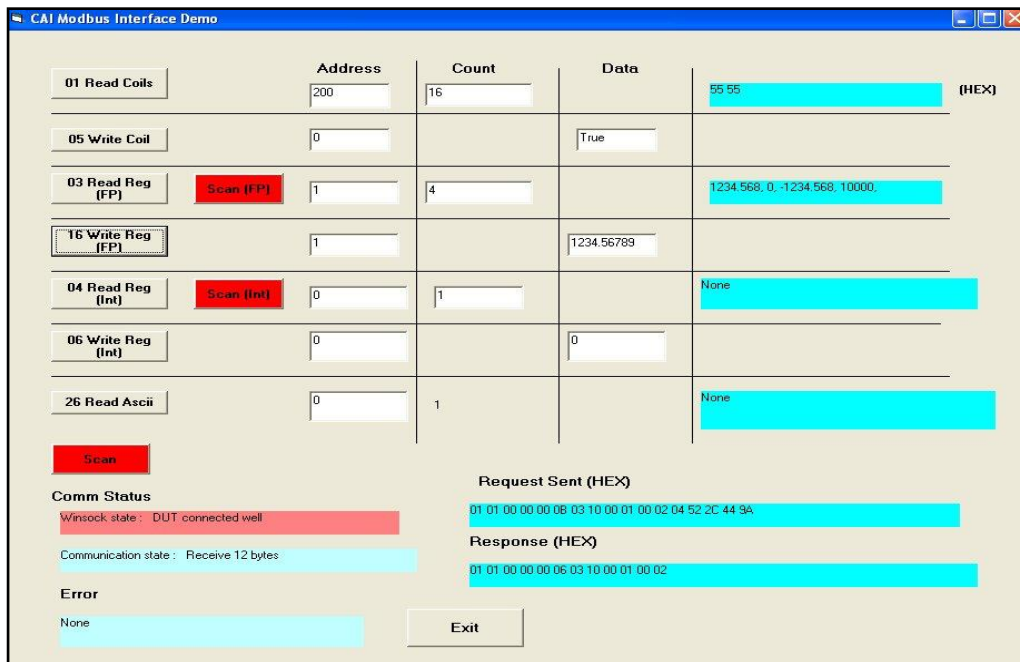

Command 16, Write one floating point register.

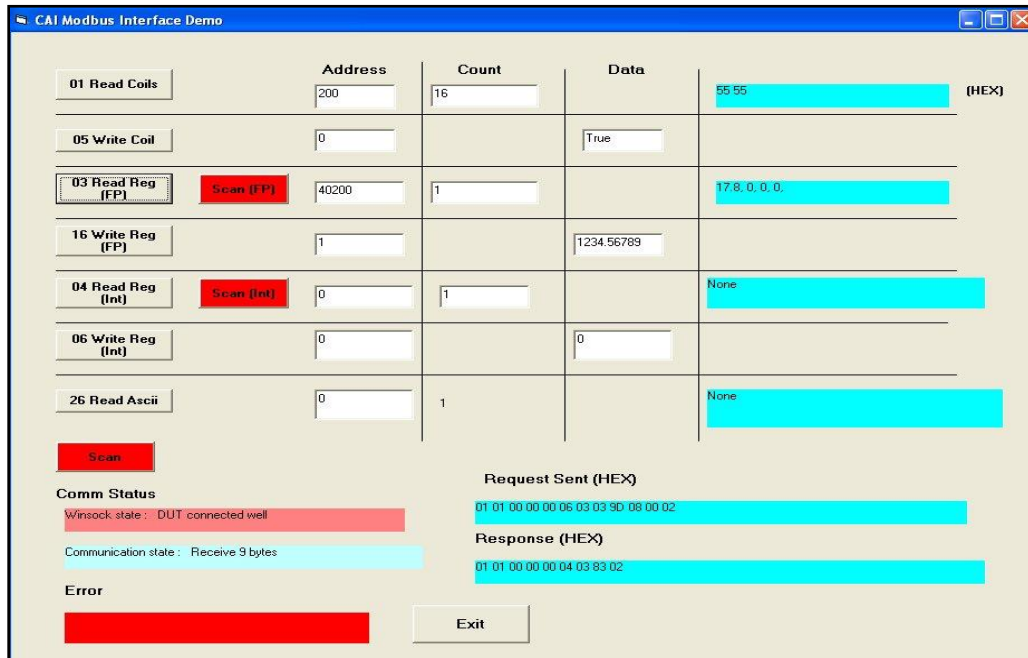

Command 16, Write one floating point register at Address 40200 showing error response.
 Not a valid address.

Code 26

This is a non-standard code used to read an ASCII string.

Request

Function Code	1 Byte	0x1A
Starting Address	2 Bytes	0x0000 to 0xFFFF
Quantity of Registers	2 Bytes	1

Response

Function Code	1 Byte	0x1A
Length of String	1 Byte	0x00 to 0x7D
String	N Bytes	Data

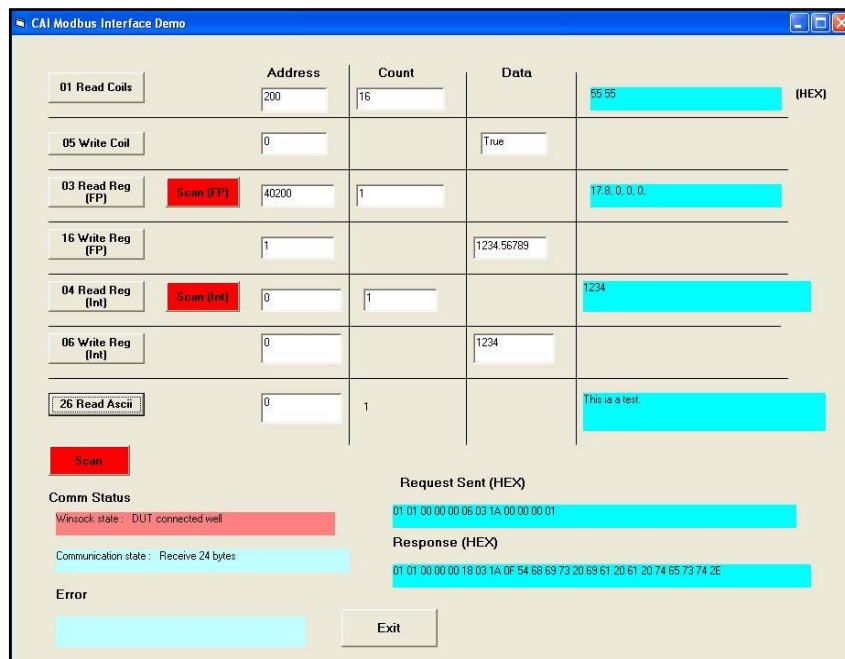

Command 26, Read ASCII string from Address 0.

Modbus Map

01H Single-Read Coil

Modbus Commands Use TCP/IP Port 502. (Do not change TCP/IP port from 7700.)

Coil Numbers and Descriptions

Coil Number	Read Data
1	Check Flow 1
2	Check Flow 2
3	Check Flow 3
4	Check External Analog 1
5	Check External Analog 2
6	Check pressure
7	Check temperature
8	Channel 1 is not calibrated
9	Channel 2 is not calibrated
10	Channel 3 is not calibrated
11	Channel 1: Low concentration warning
12	Channel 2: Low concentration warning
13	Channel 3: Low concentration warning
14	Channel 1: High concentration warning
15	Channel 2: High concentration warning
16	Channel 3: High concentration warning
17	Check Channel 1: Temperature
18	Check Channel 2: Temperature
19	Check Channel 3: Temperature
20	Check Channel 1: EPC voltage
21	Check Channel 2: EPC voltage
22	Check Channel 3: EPC voltage
23	Check Channel 1: Range overflow
24	Check Channel 2: Range overflow
25	Check Channel 3: Range overflow
Coil Number	Read Data

26	Channel 1: ADC range overflow
27	Channel 2: ADC range overflow
28	Channel 3: ADC range overflow
29	Channel 1: ADC range underflow
30	Channel 2: ADC range underflow
31	Channel 3: ADC range underflow
32	General Alarm
33	Channel 1 engineering units
34	Channel 2 engineering units
35	Channel 3 engineering units
37	For additional alarms and status
101	0 - Manual, 1 - Remote
102	0 - Standby, 1 - Measure
103	1 - Zero
104	1 - Span
105	1 - AutoCal
106	1 - Purge all channels
107	0 - Standby, 1 - Measure
108	1 - Zero
109	1 - Span
110	1 - AutoCal
111	0 - Standby, 1 - Measure
112	1 - Zero
113	1 - Span
114	1 - AutoCal
115	0 - via Pump, 1 - via Valves
116	0 - via Pump, 1 - via Valves
117	0 - via Pump, 1 - via Valves
118	0 - Auto Off, 1 - Auto On
119	0 - Auto Off, 1 - Auto On
120	0 - Auto Off, 1 - Auto On

05H Write Single Coil

Modbus Commands use TCP/IP Port 502. (Do not change TCP/IP port from 7700.)

Coil Numbers and Descriptions

Coil Number	Write Data
101	0 - Manual, 1 - Remote
102	0 - Standby, 1 - Measure
103	1 - Zero,
104	1 - Span,
105	1 - AutoCal
106	1 - Purge all channels
107	0 - Standby, 1 - Measure
108	1 - Zero,
109	1 - Span,
110	1 - AutoCal
111	0 - Standby, 1 - Measure
112	1 - Zero,
113	1 - Span,
114	1 - AutoCal
115	0 - via Pump, 1 - via Valves
116	0 - via Pump, 1 - via Valves
117	0 - via Pump, 1 - via Valves
118	0 - Auto Off, 1 - Auto On
119	0 - Auto Off, 1 - Auto On
120	0 - Auto Off, 1 - Auto On
121	1 - Sets current range offset to 0.0
122	1 - Sets current range gain to 1.0
123	1 - Sets current range offset to 0.0
124	1 - Sets current range gain to 1.0
125	1 - Sets current range offset to 0.0
126	1 - Sets current range gain to 1.0

Coil Number	Write Data
127	1 - Sets offset of range if zero gas
128	1 - sets gain of range if span gas
129	1 - Sets offset of range if zero gas
130	1 - Sets gain of range if span gas
131	1 - Sets offset of range if zero gas
132	1 - Sets gain of range if span gas
133	1 - Sets channel 1 to range 1
134	1 - Sets channel 1 to range 2
135	1 - Sets channel 1 to range 3
136	1 - Sets channel 1 to range 4
137	1 - Sets channel 2 to range 1
138	1 - Sets channel 2 to range 2
139	1 - Sets channel 2 to range 3
140	1 - Sets channel 2 to range 4
141	1 - Sets channel 3 to range 1
142	1 - Sets channel 3 to range 2
143	1 - Sets channel 3 to range 3
144	1 - Sets channel 3 to range 4

03H Read Floating Point

Modbus Commands Use TCP/IP Port 502. (Do not change TCP/IP port from 7700.)

Register Numbers and Descriptions

Register Number	Contents IEEE
40001	UNDILUTED Channel 1 concentration = diluted conc.* dil. ratio / 10000
40003	DILUTED Channel 1 concentration
40005	Channel 1 concentration before linearization & zero / span corrections
40007	Channel 1 raw detector volts
40009	UNDILUTED Channel 2 concentration = diluted conc.* dil. ratio / 10000
40011	DILUTED Channel 2 concentration
40013	Channel 2 concentration before linearization & zero / span corrections
40015	Channel 2 raw detector volts
40017	UNDILUTED Channel 3 concentration = diluted conc.* dil. Ratio / 10000
40019	DILUTED Channel 3 concentration
40021	Channel 3 concentration before linearization & zero / span corrections
40023	Channel 3 raw detector volts
40025	Channel 1 current range full scale concentration
40027	Channel 2 current range full scale concentration
40029	Channel 3 current range full scale concentration
40031	Flow 1
40033	Flow 2
40035	Flow 3
40037	External analog 1
40039	External analog 2
40041	Cell pressure
40043	Analyzer temperature
40045	Channel 1 detector temperature
40047	Channel 2 detector temperature
40049	Channel 3 detector temperature
40051	Channel 1 EPC voltage

Register Number	Contents IEEE
40053	Channel 2 EPC voltage
40055	Channel 3 EPC voltage
40061	Channel 1 range 1 offset
40063	Channel 1 range 1 gain
40065	Channel 1 range 2 offset
40067	Channel 1 range 2 gain
40069	Channel 1 range 3 offset
40071	Channel 1 range 3 gain
40073	Channel 1 range 4 offset
40075	Channel 1 range 4 gain
40077	Channel 2 range 1 offset
40079	Channel 2 range 1 gain
40081	Channel 2 range 2 offset
40083	Channel 2 range 2 gain
40085	Channel 2 range 3 offset
40087	Channel 2 range 3 gain
40089	Channel 2 range 4 offset
40091	Channel 2 range 4 gain
40093	Channel 3 range 1 offset
40095	Channel 3 range 1 gain
40097	Channel 3 range 2 offset
40099	Channel 3 range 2 gain
40101	Channel 3 range 3 offset
40103	Channel 3 range 3 gain
40105	Channel 3 range 4 offset
40107	Channel 3 range 4 gain
40109	Channel 1 range 1 full scale
40111	Channel 1 range 2 full scale
40113	Channel 1 range 3 full scale
40115	Channel 1 range 4 full scale
40117	Channel 2 range 1 full scale
40119	Channel 2 range 2 full scale

Register Number	Contents IEEE
40121	Channel 2 range 3 full scale
40123	Channel 2 range 4 full scale
40125	Channel 3 range 1 full scale
40127	Channel 3 range 2 full scale
40129	Channel 3 range 3 full scale
40131	Channel 3 range 4 full scale
40133	Channel 1 range 1 auto up
40135	Channel 1 range 2 auto down
40137	Channel 1 range 2 auto up
40139	Channel 1 range 3 auto down
40141	Channel 1 range 3 auto up
40143	Channel 1 range 4 auto down
40145	Channel 2 range 1 auto up
40147	Channel 2 range 2 auto down
40149	Channel 2 range 2 auto up
40151	Channel 2 range 3 auto down
40153	Channel 2 range 3 auto up
40155	Channel 2 range 4 auto down
40157	Channel 3 range 1 auto up
40159	Channel 3 range 2 auto down
40161	Channel 3 range 2 auto up
40163	Channel 3 range 3 auto down
40165	Channel 3 range 3 auto up
40167	Channel 3 range 4 auto down

Register Number	Contents IEEE
40201	Channel 1 range 1 span gas concentration
40203	Channel 1 range 2 span gas concentration
40205	Channel 1 range 3 span gas concentration
40207	Channel 1 range 4 span gas concentration
40209	Channel 2 range 1 span gas concentration
40211	Channel 2 range 2 span gas concentration
40213	Channel 2 range 3 span gas concentration
40215	Channel 2 range 4 span gas concentration
40217	Channel 3 range 1 span gas concentration
40219	Channel 3 range 2 span gas concentration
40221	Channel 3 range 3 span gas concentration
40223	Channel 3 range 4 span gas concentration
40225	Dilution ratio
40227	Channel 1 flow alarm minimum
40229	Channel 1 flow alarm maximum
40231	Channel 2 flow alarm minimum
40233	Channel 2 flow alarm maximum
40235	Channel 3 flow alarm minimum
40237	Channel 3 flow alarm maximum
40239	External analog 1 minimum
40241	External analog 1 maximum
40243	External analog 2 minimum
40245	External analog 2 maximum
40247	Cell pressure minimum
40249	Cell pressure maximum
40251	Analyzer temperature minimum
40253	Analyzer temperature maximum
40255	Channel 1 sample concentration minimum

Register Number	Contents IEEE
40257	Channel 1 sample concentration maximum
40259	Channel 2 sample concentration minimum
40261	Channel 2 sample concentration maximum
40263	Channel 3 sample concentration minimum
40265	Channel 3 sample concentration maximum
40267	Channel 1 detector temperature minimum
40269	Channel 1 detector temperature maximum
40271	Channel 2 detector temperature minimum
40273	Channel 2 detector temperature maximum
40275	Channel 3 detector temperature minimum
40277	Channel 3 detector temperature maximum
40279	Channel 1 sample EPC voltage minimum
40281	Channel 1 1 sample EPC voltage maximum
40283	Channel 2 sample EPC voltage minimum
40285	Channel 2 sample EPC voltage maximum
40287	Channel 3 sample EPC voltage minimum
40289	Channel 3 sample EPC voltage maximum

16H Write Floating Point

Modbus Commands Use TCP/IP Port 502. (Do not change TCP/IP port from 7700.)

Register Numbers and Descriptions

Register Number	Contents IEEE
40201	Channel 1 Range 1 span gas concentration
40203	Channel 1 Range 2 span gas concentration
40205	Channel 1 Range 3 span gas concentration
40207	Channel 1 Range 4 span gas concentration
40209	Channel 2 Range 1 span gas concentration
40211	Channel 2 Range 2 span gas concentration
40213	Channel 2 Range 3 span gas concentration
40215	Channel 2 Range 4 span gas concentration
40217	Channel 3 Range 1 span gas concentration
40219	Channel 3 Range 2 span gas concentration
40221	Channel 3 Range 3 span gas concentration
40223	Channel 3 Range 4 span gas concentration
40225	Dilution ratio
40227	Channel 1 flow alarm minimum
40229	Channel 1 flow alarm maximum
40231	Channel 2 flow alarm minimum
40233	Channel 2 flow alarm maximum
40235	Channel 3 flow alarm minimum
40237	Channel 3 flow alarm maximum
40239	External analog 1 minimum
40241	External analog 1 maximum
40243	External analog 2 minimum
40245	External analog 2 maximum
40247	Cell pressure minimum
40249	Cell pressure maximum

Register Number	Contents IEEE
40251	Analyzer temperature minimum
40253	Analyzer temperature maximum
40255	Channel 1 sample concentration minimum
40257	Channel 1 sample concentration maximum
40259	Channel 2 sample concentration minimum
40261	Channel 2 sample concentration maximum
40263	Channel 3 sample concentration minimum
40265	Channel 3 sample concentration maximum
40267	Channel 1 detector temperature minimum
40269	Channel 1 detector temperature maximum
40271	Channel 2 detector temperature minimum
40273	Channel 2 detector temperature maximum
40275	Channel 3 detector temperature minimum
40277	Channel 3 detector temperature maximum
40279	Channel 1 sample EPC voltage minimum
40281	Channel 2 sample EPC voltage maximum
40283	Channel 2 sample EPC voltage minimum
40285	Channel 2 sample EPC voltage maximum
40287	Channel 3 sample EPC voltage minimum
40289	Channel 3 sample EPC voltage maximum

Warranty Statement

Subject to the exceptions and upon the conditions stated below, California Analytical Instruments (CAI) warrants that the products sold under this sales order shall be free from defects in workmanship and materials for one year after delivery of the product to the original Buyer by CAI and if any such product should prove to be defective within such one year period, CAI agrees, at its option, either (i) to correct by repair or, at CAI's election, by replacement with equivalent product any such defective product, provided that investigation and factory inspection discloses that such defect developed under normal and proper uses, or (ii) to refund the purchase price. The exceptions and conditions mentioned above are as follows:

- a) components or accessories manufactured by CAI which by their nature are not intended to and will not function for one year are warranted only to give reasonable service for a reasonable time; which constitutes reasonable time and reasonable services shall be determined solely by CAI. A complete list of such components and accessories is maintained at the factory;
- b) CAI makes no warranty with respect to components or accessories not manufactured by it; in the event of defect in any such component or accessory CAI will give reasonable assistance to Buyer in obtaining from the respective manufacturer whatever adjustment is authorized by the manufacturer's warranty;
- c) any product claimed to be defective must be returned to the factory transportation charges prepaid and CAI will return the repaired or replaced product freight collect;
- d) if the product claimed to be defective requires on-site repair, such warranty labor will be provided at no charge; however, transportation and living expenses will be charged to Buyer;
- e) if the product is a consumable or the like, it is warranted only to conform to the quantity and content and for the period (but not in excess of one year) stated on the label at the time of delivery or 90 days;

- f) CAI may from time to time provide a special printed warranty with respect to a certain product, and where applicable, such warranty shall be deemed incorporated herein by reference;
- g) CAI shall be released from all obligations under all warranties, either expressed or implied, if any product covered hereby is repaired or modified by persons other than its own authorized service personnel unless such repair by others is made with the written consent of CAI.

IT IS EXPRESSLY AGREED THAT THE ABOVE WARRANTY SHALL BE IN LIEU OF ALL WARRANTIES OF FITNESS AND OF THE WARRANTY OF MERCHANTABILITY AND THAT CAI SHALL HAVE NO LIABILITY FOR SPECIAL OR CONSEQUENTIAL DAMAGES OF ANY KIND OR FROM ANY CAUSE WHATSOEVER ARISING OUT OF THE MANUFACTURE USE, SALE, HANDLING, REPAIR, MAINTENANCE OR REPLACEMENT OF ANY OF THE PRODUCTS SOLD UNDER THIS SALES ORDER. SOME STATES DO NOT ALLOW THE EXCLUSION OR LIMITATION OF INCIDENTAL OR CONSEQUENTIAL DAMAGES, SO THAT THE ABOVE LIMITATIONS OR EXCLUSIONS MAY NOT APPLY. THIS WARRANTY GIVES YOU SPECIFIC LEGAL RIGHTS, AND YOU MAY ALSO HAVE OTHER RIGHTS, WHICH VARY FROM STATE TO STATE.

Representations and warranties made by any person, including dealers and representatives of CAI, which are inconsistent, or in conflict with the terms of this warranty, shall not be binding upon CAI unless reduced to writing and approved by an expressly authorized officer of CAI.