

650

SERIES

CLD/O₂



USER'S MANUAL

Note: For Analyzers Sold After June, 2007 Please See Addendum Starting After Page 86 of This Manual



1312 West Grove Avenue
Orange, CA 92865-4134
Phone: 714-974-5560 Fax: 714-921-2531
www.gasanalyzers.com

650 Quick Start Guide

- 1) Plug in the analyzer and turn the power on.
- 2) Connect the appropriate gas lines and vents to the analyzer.
- 3) Allow the analyzer to stabilize for at least one (1) hour.
- 4) During the analyzer's stabilization period, setup the analyzer to the desired configuration.
 - a) Set the analyzer's output as desired.
 - i) From the Main Menu press F5 (Setup) then F7 (System Settings.)
 - ii) Press F3 (output assignments) to setup the output channels.
 - (1) Set to real time
 - (2) Set channel 2 to NO
 - (3) Set channel 3 to NO₂
 - (4) Set channel 4 to O₂
 - (5) Press back to return to the system settings menu.
 - iii) Press F4 (output range) to setup the output ranges
 - (1) Set the Min and Max to zero (0). This will cause the outputs to default to the analyzer ranges.
 - (2) Set the outputs for milliamps (mA) or voltage (V) as desired.
 - (a) The mA setting will give 4-20 mA or 2-10V (if 500 ohm resistors are installed).
 - (b) The V setting will give 0-20mA or 0-10V (if 500 ohm resistors are installed).
- 5) Connect all appropriate analog outputs.
 - a) Pin 1 is the output common (ground).
 - b) Pins 2, 3, 4, and 5 are output channels 1, 2, 3, and 4 as setup in step 4.a.ii.
 - c) If the output is set for voltages but there is no voltage output, you will need to install a 500 ohm resistor between pin 1 and the channel you are trying to measure. You will have to measure the voltage drop across this resistor.
- 6) Press F1 from the analyzer's main Menu to get to the measurement screen.
 - a) The individual NO, NO_x, and NO₂ channels only work while measuring in dual mode. (Real time and O₂ output continuously)
 - b) Press F2 while in the measurement screen to get to dual measurement mode.
- 7) Supply sample gas to the analyzer.
- 8) The measurement screen should indicate the concentration of the sample gas. If the concentration is incorrect, the analyzer will need to be Zeroed and Spanned using your calibration gases. Please reference the appropriate section of the manual for a description on how to zero and span the analyzer.

TABLE OF CONTENTS

1. Introduction.....	10
1.1. Overview.....	10
1.2. Unpacking Instructions.....	10
1.3. Reporting Damage.....	10
1.4. Contact Information.....	10
1.5. Warranty Certificate.....	11
2. Features.....	12
2.1. Description.....	12
2.2. Features-General.....	12
2.3. Model 650 CLD/Paramagnetic Specifications.....	13
3. Installation.....	14
3.1. General.....	14
3.2. Site and Mounting.....	14
3.3. Electrical.....	15
3.4. Analog Output Connections (Appendix).....	16
3.5. Gases.....	16
3.6. Gas Handling Equipment.....	16
3.7. Gas Connections.....	16
3.8. Sampling Requirements.....	17
3.8.1. Filtration.....	17
3.8.2. Condensation.....	17
3.8.3. Presence of Corrosive Gases.....	17
3.8.4. Gas Temperature.....	17
3.8.5. Pressure and Flow Rates.....	17
4. Basic Operation.....	18
4.1. Display.....	18
4.2. Menu Tree.....	19
4.3. Keyboard.....	22
4.3.1. Operation with the Cursor Keys and the Enter Key.....	22
4.3.2. Operation with the Function Keys.....	22
4.3.3. Read/Change Parameters.....	22
5. Operating Structure.....	23

5.1.	The Main Menu.....	24
6.	Menu Structure	25
6.1.	User Functions (Level 1)	25
6.2.	Advanced User Functions (Level 2)	25
6.3.	Maintenance Functions (Level 3)	25
6.4.	System User Functions (Level 4)	25
7.	Main Menu Function Descriptions	26
7.1.	F1 Measurements.....	26
7.1.1.	F1 NO or NO _x Measurement.....	26
7.1.2.	F2 NO + NO _x Measurement.....	27
7.2.	F3 Diagnostics.....	27
7.3.	Select Range	28
7.4.	F2 Purge Analyzer.....	28
7.5.	F3 Diagnostics.....	29
7.6.	F4 Calibrations	29
7.6.1.	F1 Automatic Calibration.....	30
7.6.2.	F2 Manual Calibration	31
7.7.	F3 Display Deviations.....	33
7.7.1.	Absolute Zero Gas Deviation	34
7.7.2.	Relative Zero Gas Deviation	34
7.7.3.	Absolute Span Gas Deviation	34
7.7.4.	Relative Span Gas Deviation	34
7.7.5.	F4 Check Calibration.....	35
7.7.6.	F5 Reset Calibration Values	35
7.7.7.	F6 Range Select	35
7.8.	F5 Setup.....	36
7.8.1.	F1 Span Gas Concentration	37
7.8.2.	F2 Calibration Settings.....	37
7.8.3.	F1 Times	38
7.8.4.	F2 Measuring Deviations	38
7.8.5.	F3 Deviations	38
7.8.6.	F4 Calibrations via Solenoids	39
7.8.7.	F5 Calibration via Probe.....	39
7.8.8.	F3 Range Limits	39
7.8.9.	F1 Range 1-4 (Change Upper Range Limits).....	40

7.8.10.	F2 Change Auto Range Limits	40
7.8.11.	Alarms	41
7.8.12.	Password.....	41
7.8.13.	F1 Enter Password.....	42
7.8.14.	F2 Change Password.....	42
7.8.15.	F3 Reset Passwords	42
7.8.16.	Linearization	43
7.8.17.	F7 System Settings	43
7.8.18.	F1 Real Time Clock.....	44
7.8.19.	F2 Set autocalibration time	44
7.8.20.	F3 Set Auto Cal Ranges	45
7.8.21.	F4 Autocalibration on/off	45
7.8.22.	Auto calibration	45
7.8.23.	F2 Displays TCP/IP Address.....	46
7.8.24.	F3 Displays Output Signal Assignments.....	46
7.8.25.	F4 Displays Output Ranges	46
7.8.26.	F5 Turns Status Line On or Off.....	47
7.8.27.	F8 Measure Settings	47
7.8.28.	Set NO ₂ Mode Times	47
7.8.29.	F2 Converter Efficiency.....	48
7.8.30.	Low Pass Filter Time Constant.....	48
7.8.31.	F4 Purge Time.....	48
7.8.32.	F10 Displays the Current Analyzer and Software Versions.....	49
7.9.	F7 Remote / Manual Control	50
7.10.	F8 Standby	50
8.	Analyzer Components.....	51
8.1.	Rear Panel.....	51
8.2.	Main Connector (Standard 28 Pin Connector)	52
8.2.1.	Main Connector (Standard 28 Pin Connector).....	52
8.2.2.	Auxiliary Connector (Standard 28 Pin Connector).....	52
8.2.3.	Digital Outputs – RS-232 (Standard 9 Pin DIN Connector).....	52
8.2.4.	Digital Outputs – TCP/IP (8 Pin RJ-47 Connector).....	53
8.3.	Internal Component Locations.....	54
8.4.	Main Electronics Board (Potentiometers).....	55
8.5.	Main Electronic Board Potentiometers	55
8.6.	Main Electronics Board (Connectors).....	56

8.7.	Main Electronic Board Connectors	56
8.8.	Reaction Chamber.....	57
8.9.	Relay Board Connections.....	58
9.	Operation.....	59
9.1.	Preparation for Operation	59
9.2.	Operation.....	59
9.3.	Shut Down Procedure	60
10.	Functional Description.....	61
10.1.	Operating Principle- NO/NO _x	61
10.1.1.	Reaction Chamber	61
10.1.2.	Flow System.....	61
10.1.3.	Main Electronics Board	61
10.1.4.	Relay Board.....	61
10.2.	Principle of Operation-Oxygen	62
10.3.	Cross sensitivity of gases	64
11.	Reaction Chamber Servicing.....	66
11.1.	Disassembly Procedure.....	66
11.2.	Assembly Procedure	66
12.	Troubleshooting	67
12.1.	Ozone Air/O ₂ Supply	67
12.2.	Sample Supply	67
12.3.	NO/NO _x Converter	67
13.	AK Protocol Format.....	68
13.1.	Serial Interface and AK-Commands	68
13.2.	Interface Parameters.....	68
13.3.	General AK Requirements.....	69
13.4.	Scans	69
13.5.	Control commands	76
13.6.	Settings	79
13.7.	Abbreviations used.....	81
14.	Appendix	82
14.1.	MODEL 650 NO _x /O ₂ Flow Diagrams	82
14.2.	Electrical Block Diagram.....	86

Table of Figures

Figure 3-1 AC Power Switch, Connector, and Fuse	15
Figure 3-2 EMI Suppressor	15
Figure 4-1 Measurement Screen	18
Figure 4-2 Keyboard	22
Figure 5-1 Main Menu on Power Up Screen	24
Figure 5-2 Main User Menu (Level 4)	24
Figure 7-1 Main Menu Screen	26
Figure 7-2 Measurements Screen	26
Figure 7-3 Measurement Screen	27
Figure 7-4 First Diagnostics Screen.....	27
Figure 7-5 Second Diagnostics Screen	27
Figure 7-6 Set to Auto-Range	28
Figure 7-7 Analyzer set to Range 3	28
Figure 7-8 Main Menu (User Level 4)	28
Figure 7-9 Purge Screen.....	28
Figure 7-10 Main User Menu (Level 4)	29
Figure 7-11 Main User Menu (Level 4)	29
Figure 7-12 Calibration Screen (Level 4).....	29
Figure 7-13 Auto Calibration Screen.....	30
Figure 7-14 F2 Manual Calibration	31
Figure 7-15 Manual Calibration Screen	31
Figure 7-16 Manual zero gas calibration	31
Figure 7-17 Manual Span gas calibration	31
Figure 7-18 Range select.....	32
Figure 7-19 Selected range 1	32
Figure 7-20 Selected range 2	32
Figure 7-21 Selected range 3	32
Figure 7-22 Selected range 4	32
Figure 7-23 Selected auto range	32
Figure 7-24 F3 Display deviations	33
Figure 7-25 Display deviations screen.....	33
Figure 7-26 Zero gas deviations	34
Figure 7-27 Zero gas deviations verifying.....	34
Figure 7-28 Span gas deviations	34
Figure 7-29 Span gas deviations verifying.....	34
Figure 7-30 F4 Check calibration.....	35

Figure 7-31 Check Calibration	35
Figure 7-32 F5 Reset calibration values	35
Figure 7-33 Reset calibration values	35
Figure 7-34 Range Select	35
Figure 7-35 Range	35
Figure 7-36 Main menu (User level 4)	36
Figure 7-37 Setup menu 1	36
Figure 7-38 Setup menu 2	36
Figure 7-39 Change span gas settings	37
Figure 7-40 Change Auto Calibration Settings	37
Figure 7-41 Setup-times.....	38
Figure 7-42 Measuring deviations.....	38
Figure 7-43 Absolute versus relative deviations	38
Figure 7-44 Calibrations via internal solenoid valves	39
Figure 7-45 Calibration via probe.....	39
Figure 7-46 Change Range Limits	39
Figure 7-47 Change Upper Range Limits	40
Figure 7-48 Change Auto Range Limits.....	40
Figure 7-49 Set Temperature Alarms	41
Figure 7-50 Set Concentration, Pressure and Voltage Alarms.....	41
Figure 7-51 Enter / Change Password.....	41
Figure 7-52 Access Level Screen	42
Figure 7-53 Passwords	42
Figure 7-54 Linearization Screen.....	43
Figure 7-55 Coefficients Range Select	43
Figure 7-56 Linearization Coefficients	43
Figure 7-57 Range Raw Data with F2.....	43
Figure 7-58 system settings.....	43
Figure 7-59 System Setup Screen.....	43
Figure 7-60 Clock and Timing Setup Screen	44
Figure 7-61 Set Clock Screen	44
Figure 7-62 Select autocalibration time	44
Figure 7-63 Set Autocalibration Cal Timing	44
Figure 7-64 Clock and Timing Setup Screen.....	45
Figure 7-65 F4 Toggles Auto Cal ON of OFF	45
Figure 7-66 Autocalibration Status.....	45
Figure 7-67 TCP/IP Address.....	46

Figure 7-68 Output Assignments	46
Figure 7-69 Output Ranges	46
Figure 7-70 Status Line.....	47
Figure 7-71 Menu Settings Screen	47
Figure 7-72 Set NO ₂ Purge and Measure Time.....	47
Figure 7-73 Set Converter Efficiency	48
Figure 7-74 Set Time Constant.....	48
Figure 7-75 Set Purge Time.....	48
Figure 7-76 Analyzer Information Version	49
Figure 7-77 Software Version	49
Figure 7-78 Remote manual control	50
Figure 7-79 Standby selection	50
Figure 7-80 Standby screen.....	50
Figure 8-1 Major Internal Components	54
Figure 8-2 Reaction Chamber Pre-Amplifier.....	57
Figure 8-3 Relay Board Connections.....	58
Figure 10-1 Magnetic Susceptibility of gases	62
Figure 10-2 The Measuring cell in theory	62
Figure 10-3 Principle of operation.....	63
Figure 14-1: Standard Analyzer	82
Figure 14-2: Standard Analyzer with Optional Zero/Span Solenoids	83
Figure 14-3: Standard Analyzer with Optional Sample Pump	84
Figure 14-4: Standard Analyzer with Optional Sample Pump and Zero/Span Solenoids	85

Tables

Table 10-1 Cross Sensitivity of gases.....	65
--	----

1. Introduction

1.1. Overview

Congratulations and thank you! You have just purchased one of the most reliable gas analyzers in the world. Before using the analyzer, please familiarize yourself with its operation by reading this manual. If you have any questions, please do not hesitate to call California Analytical Instruments for assistance. We want you to be a member of our thousands of satisfied customers.

1.2. Unpacking Instructions

Open the shipping container and carefully remove the analyzer from the packing materials. Inspect the instrument for any sign of damage. Remove the Top Cover retaining screws. Visually check for loose parts or connectors that are not properly seated. Verify all circuit boards and circuit board connections are secure. If all internal components look normal, re-install the cover.

1.3. Reporting Damage

Should there be any apparent damage to either the inside or outside of the instrument due to shipping or handling, immediately notify the shipper. The shipping container or packing materials should be retained for inspection by the shipper.

1.4. Contact Information

California Analytical Instruments, Inc.
1312 West Grove Avenue
Orange, CA 92865
714 974-5560
Fax 714 921-2531
Website: www.gasanalyzers.com

1.5. Warranty Certificate

Subject to the exceptions and upon the conditions stated below, California Analytical Instruments (CAI) warrants that the products sold under this sales order shall be free from defects in workmanship and materials for one year after delivery of the product to the original Buyer by CAI and if any such product should prove to be defective within such one year period, CAI agrees, at its option, either (i) to correct by repair or, at CAI's election, by replacement with equivalent product any such defective product, provided that investigation and factory inspection discloses that such defect developed under normal and proper uses, or (ii) to refund the purchase price. The exceptions and conditions mentioned above are as follows:

- a. components or accessories manufactured by CAI which by their nature are not intended to and will not function for one year are warranted only to give reasonable service for a reasonable time; which constitutes reasonable time and reasonable services shall be determined solely by CAI. A complete list of such components and accessories is maintained at the factory;
- b. CAI makes no warranty with respect to components or accessories not manufactured by it; in the event of defect in any such component or accessory CAI will give reasonable assistance to Buyer in obtaining from the respective manufacturer whatever adjustment is authorized by the manufacturer's warranty;
- c. any product claimed to be defective must be returned to the factory transportation charges prepaid and CAI will return the repaired or replaced product freight collect;
- d. if the product claimed to be defective requires on-site repair, such warranty labor will be provided at no charge; however, transportation and living expenses will be charged to Buyer;
- e. if the product is a consumable or the like, it is warranted only to conform to the quantity and content and for the period (but not in excess of one year) stated on the label at the time of delivery or 90 days;
- f. CAI may from time to time provide a special printed warranty with respect to a certain product, and where applicable, such warranty shall be deemed incorporated herein by reference;
- g. CAI shall be released from all obligations under all warranties, either expressed or implied, if any product covered hereby is repaired or modified by persons other than its own authorized service personnel unless such repair by others is made with the written consent of CAI.

IT IS EXPRESSLY AGREED THAT THE ABOVE WARRANTY SHALL BE IN LIEU OF ALL WARRANTIES OF FITNESS AND OF THE WARRANTY OF MERCHANTABILITY AND THAT CAI SHALL HAVE NO LIABILITY FOR SPECIAL OR CONSEQUENTIAL DAMAGES OF ANY KIND OR FROM ANY CAUSE WHATSOEVER ARISING OUT OF THE MANUFACTURE USE, SALE, HANDLING, REPAIR, MAINTENANCE OR REPLACEMENT OF ANY OF THE PRODUCTS SOLD UNDER THIS SALES ORDER. SOME STATES DO NOT ALLOW THE EXCLUSION OR LIMITATION OF INCIDENTAL OR CONSEQUENTIAL DAMAGES, SO THAT THE ABOVE LIMITATIONS OR EXCLUSIONS MAY NOT APPLY. THIS WARRANTY GIVES YOU SPECIFIC LEGAL RIGHTS, AND YOU MAY ALSO HAVE OTHER RIGHTS, WHICH VARY FROM STATE TO STATE.

Representations and warranties made by any person, including dealers and representatives of CAI, which are inconsistent, or in conflict with the terms of this warranty, shall not be binding upon CAI unless reduced to writing and approved by an expressly authorized officer of CAI.

2. Features

2.1. Description

The CAI Model 650 NO_x/O₂ Analyzer is a highly sensitive chemiluminescent (CLD) gas analyzer and a reliable paramagnetic oxygen analyzer. It measures oxides of nitrogen gas and dry basis oxygen concentrations in industrial and vehicle emission applications.

2.2. Features-General

The Model 650 NO_x/O₂ analyzer has a 3 by 5 inch liquid crystal display and a 20 key data/operation input keyboard. The 16 bit microprocessor control board consists of the MSR-Card with 16 digital inputs, 16 digital outputs, 16 analog inputs and 4 analog outputs. The analyzer can be manually operated from the key pad or remotely via TCP/IP or RS-232C communications. After turning on the analyzer, it needs at least 30 seconds for initialization. During this time, the screen is illuminated. The analyzer is available with an optional internal heated sample pump and internal zero and span solenoids.

IMPORTANT TIP: When the analyzer is powered up, it defaults to access level 1 (User). To operate ALL parameters, check the access level. See Section 7.5.13.

The contents of this operator's manual include:

- 9) Specifications
- 10) Installation Requirements, Mechanical & Electrical
- 11) Operation & Calibration Instructions
- 12) Reaction Chamber Description with Procedures for Disassembly of its Component Parts
- 13) Function Explanation of the Electronic Circuitry
- 14) Electrical Block Diagram

2.3. Model 650 CLD/Paramagnetic Specifications

DETECTORS	Chemiluminescence (CLD) Photodiode /Paramagnetic (O ₂)
NO/NO_x RANGES	0-1 to 3,000 ppm NO or NO _x (Four user-definable ranges) (Higher Ranges Available upon Request)
OXYGEN RANGE	0-25%
RESPONSE TIME	T90 < 3 Seconds to 60 Seconds Adjustable
RESOLUTION – DETECTION LIMIT	0.03 ppM NO/NO _x (Displays 5 significant digits)
REPEATABILITY	Better than 0.5% of Full Scale
LINEARITY	Better than 1.0% of Full Scale
NOISE	Less than 0.5% of Full Scale
ZERO & SPAN DRIFT	Less than 1% of Full Scale per 24 Hours
ZERO & SPAN ADJUSTMENT	Via front panel, TCP/IP or RS-232
CO₂ EFFECT	Less than 0.5% with 10% CO ₂
ADDITIONAL INTERFERENCE DATA	CO 1000 ppm – NA, H₂CN 28 ppm – N/A, SO₂ 500 ppm – N/A, NH₃ 10 ppm – N/A, N₂O 201 ppm – N/A
FLOW CONTROL	Electronic Proportional Pressure Controller
SAMPLE FLOW RATE	3.0 LPM ± 1 LPM
CONVERTER	Carbon Material @ 205°C > 98% to 100% Efficiency
OZONATOR	Ultraviolet Lamp
AIR OR O₂ REQUIREMENTS	Dry air less than 0.01 ppm NO _x at 250 cc/Min. @ 25 psig
NO/NO_x Control	Manual/Remote/Auto Cycle (Remote NO _x mode by dry contact closure)
OUTPUTS AVAILABLE	Scalable to 0-10 V or 4-20 mADC, RS232 and TCP/IP
DISCRETE ALARMS	General Fault/ TTL Logic (Ground True) Calibration Failure/ TTL Logic (Ground True) High Concentration (2 each)/ TTL Logic (Ground True)
DIGITAL DIAGNOSTICS	<ul style="list-style-type: none"> • Converter Temperatures • Cell Temperatures • Photodiode Temperatures • Air Pressures, Flow Rate and EPC Control Voltage • Sample Pressure, Flow Rate and EPC Control Voltage
KEYPAD DISPLAYS	<ul style="list-style-type: none"> • Factory Settings • TCP/IP Address • Scalable Analog Output Voltages • Passwords (4)Full • Scale Range Select • Auto Cal Times
SPECIAL FEATURES	<ul style="list-style-type: none"> • Calculated NO₂ values from empirically derived NO_x converter efficiencies • Auto Ranging • Auto Calibration (adjustable through internal clock)
DISPLAY	Back lit LCD
SAMPLE TEMPERATURE	50°C Non-condensing
CHAMBER TEMPERATURE	66°C
AMBIENT TEMPERATURE	5 to 40°C
AMBIENT HUMIDITY	Less than 90% RH Non-condensing
WARM-UP TIME	1 Hour
FITTINGS	1/4 Inch Tube
POWER REQUIREMENTS	115/230 (±10%) VAC; 50/60 Hz; Less than 3 amps
DIMENSIONS	5¼ H × 19 W × 23 D (Inches)
WEIGHT	48 Pounds

SPECIFICATIONS ARE SUBJECT TO CHANGE WITHOUT NOTICE

3. Installation

3.1. General

The instrument is designed for industrial applications. These installation instructions are for a typical site. Any questions regarding specific installation situations should be directed to Technical Service of California Analytical Instruments, Inc.

3.2. Site and Mounting

NOTE: The following precautions must be carefully observed:

- 1) Select a site free from direct sunlight, radiation from a high temperature surface, or abrupt temperature variations.
- 2) This analyzer is not suitable for installation outdoors.
- 3) Select a site where the air is clean. Avoid exposing the instrument to corrosive or combustible gases.
- 4) The instrument must not be subject to severe vibration. If severe vibration is present, use isolation mounts.
- 5) The instrument is designed for rack-mounting. Optional rack mount slides are available.
- 6) Do not install near equipment emitting electromagnetic interference (EMI).

NOTE: A rear supporting brace or equivalent is required if the optional rack mount slides were not purchased.

3.3. Electrical

All wiring is connected at the rear of the instrument. The AC power is connected to the power/fuse/switch as shown below:

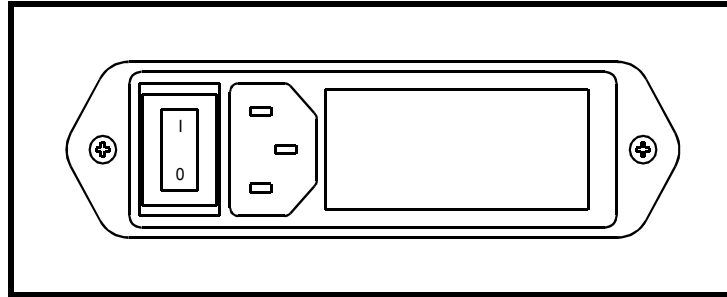

Figure 3-1 AC Power Switch, Connector, and Fuse

NOTE: A defective ground may affect the operation of the instrument. The output voltages are connected per Table 8.1.1. Shielded wiring is recommended for output signals.

CAUTION: Electromagnetic interference (EMI) may affect the operation of the instrument. Do not install the instrument in the vicinity of electrical noise (such as high frequency furnaces, electric welding machines, etc.). If the instrument must be installed at such locations, a separate power line must be used. Noise from a relay or solenoid valve should be controlled by the use of an EMI suppressor (RC circuit) across the power wiring close to the noise-generating component.

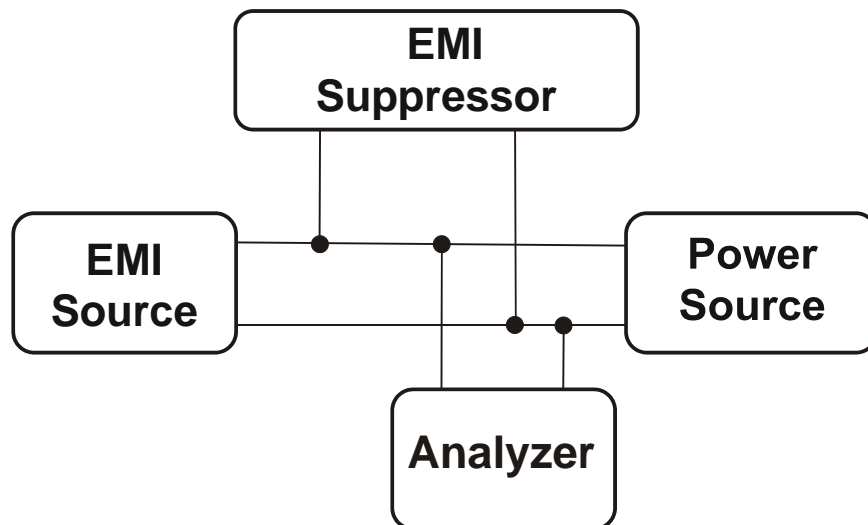

Figure 3-2 EMI Suppressor.

NOTE: The EMI Suppressor must be located close to the noise source.

3.4. Analog Output Connections (Appendix)

See Appendix for connector pinouts located on the analyzer rear panel. Remote range identification and range selection are obtained via the rear panel connections. When a range is selected, the corresponding control line is pulled low to zero VDC. Ranges not selected will remain at approximately 5 VDC. When remote range control is selected on the front panel switch, a contact closure is provided at the rear panel connector. Remote range selection is made by connection of the control line for the desired range to the analyzers zero VDC line provided in the connector. Five VDC is also provided. Remote NO_x On is selected by connection to the common line. This contact closure turns on the NO_x function by flowing the sample first through the NO/NO_x converter.

3.5. Gases

- 1) Air or O₂ (Ozone Air, < 1 ppm C) in pressurized cylinder.
- 2) Nitrogen or (zero air) in pressurized cylinder.
- 3) Standard span gas(es) near full scale concentration with a nitrogen balance, in a pressurized, certified cylinder.

3.6. Gas Handling Equipment

- 1) Pressure regulators for zero gas (Air or N₂), ozone supply (air or O₂) and span gas cylinders.
- 2) Corrosive resistant gas tubing.

NOTE: High levels of NH₃ (greater than 10 PPM NH₃) may reduce the NO₂ to NO Converter's conversion efficiency to a level that is unacceptable. It is therefore recommended that the customer purchase a commercially available NH₃ scrubber and install it in the path of the sample gas prior to its introduction into the analyzer.

3.7. Gas Connections

The tubing from the sampling system to the gas analyzer should be made from corrosive-resistant material such as Teflon or stainless steel. Even when the gases being sampled are corrosive themselves, rubber or soft vinyl tubing should not be used since readings may be inaccurate due to gas absorption into the piping material. To obtain fast response, the tube should be as short as possible. Optimum tube internal diameter is 0.16 inch (4 mm). Couplings to the instrument are ¼ Inch tube.

NOTE: Be sure tubing and joints are clean. Dust entering the instrument may cause it to malfunction.

3.8. Sampling Requirements

3.8.1. Filtration

Dust must be eliminated completely. Use filters as necessary. The final filter must be capable of removing particles larger than 4 microns.

3.8.2. Condensation

Dew point of the sample gases must be lower than the instrument temperature to prevent accidental condensation within the instrument. Bypass the sample through a dehumidifier to reduce the dew point to about 2 to 4°C or less. If the sample contains an acid mist, use an acid mist filter, cooler or similar device to remove all traces of the mist.

3.8.3. Presence of Corrosive Gases

Useful service life of the instrument will be shortened if high concentrations of corrosive gases such as Cl₂, SO₂, F₂, HCl, etc., are present in the sampled gas.

3.8.4. Gas Temperature

When measuring high temperature gases, take care that the maximum rating of the instrument 104 °F (50 °C) is not exceeded.

3.8.5. Pressure and Flow Rates

The air or oxygen supply entering the instrument is controlled by an electronically controlled proportional flow (EPC) controller. The regulator is factory adjusted for optimum analyzer performance. The ozone supply (Air or O₂) air cylinder pressure should be set at approximately 25 PSIG. The sample entering the instrument is controlled by a factory set precision electronically controlled proportional flow (EPC) controller. The EPC is factory set for optimum analyzer performance as indicated by the sample pressure. If the analyzer does not contain the optional internal sample pump, the sample gas entering the instrument should be at a pressure between 10 and 25 PSIG with a flow capacity at a minimum of 3 liters/min. If the analyzer contains the optional sample pump, do not apply a pressurized sample. The optional pump is capable of drawing a sample through a ¼ inch heated sample line of approximately 75 feet. The calibration/span gas cylinder pressures should be set at 25 PSIG for delivery into the optional zero and span inlets located on the rear panel.

NOTE: If the analyzer contains an optional internal sample pump, the introduction of a pressurized sample gas in excess of 1.5 PSIG will damage the pump.

3.8.6. Sample Gas Bypass Outlet (Vent)

A sample gas bypass outlet connector is located on the rear panel (¼ Inch Tube). Pressure at this outlet should be kept at atmospheric level. **ANY** backpressure will cause an error in reading. The vent outlet is located on the rear panel and may contain high levels of ozone which should be vented away from the instrument.

4. Basic Operation

The operation of the digital microprocessor conforms to the guidelines of the AK committee, originally developed in the German automotive industry. Via the serial port of the MSR-Card, the analyzer can be remote-controlled by a master computer. The serial communication fully corresponds to the specifications of the AK protocol. TCP/IP communication is also available.

4.1. Display

The analyzer's LCD display includes 16 lines with 30 characters each. The display also has background lighting that can be switched on and off via the Display key on the keyboard. The following example shows the measurement screen which is formatted into 4 information areas.

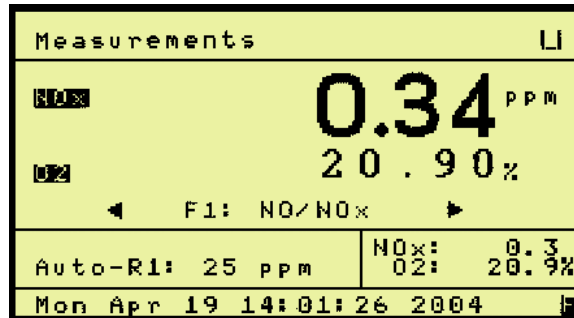

Figure 4-1 Measurement Screen

THE TOP INFORMATION AREA CONTAINS:

The AK Protocol Information. This capability is for advanced uses and may be toggled on and off in the setup screen, F5. Next to the symbol for the active operating mode, the device status is indicated. The status field is also displayed on all other screens.

- SARE Aurorange enabled
- SMGA Measuring gas is flowing
- SMAN Device is in manual operation status
- SWET What?

The level of Password Entry is shown on the right with 1 to 4 horizontal lines.

THE LARGE INFORMATION AREA CONTAINS:

The date portion of the screen.

THE THIRD INFORMATION AREA CONTAINS:

The help information for the parameter selected, ranges, etc.

THE LOWER INFORMATION AREA CONTAINS:

The time and date and any error condition.

The symbol in the bottom right corner indicates the keyboard mode. In the example shown, the keyboard is in the function key mode. For input fields, the mode is usually switched to numerical input. Then, an N appears in the lower right of the screen. This symbol is displayed on all screens.

4.2. Menu Tree

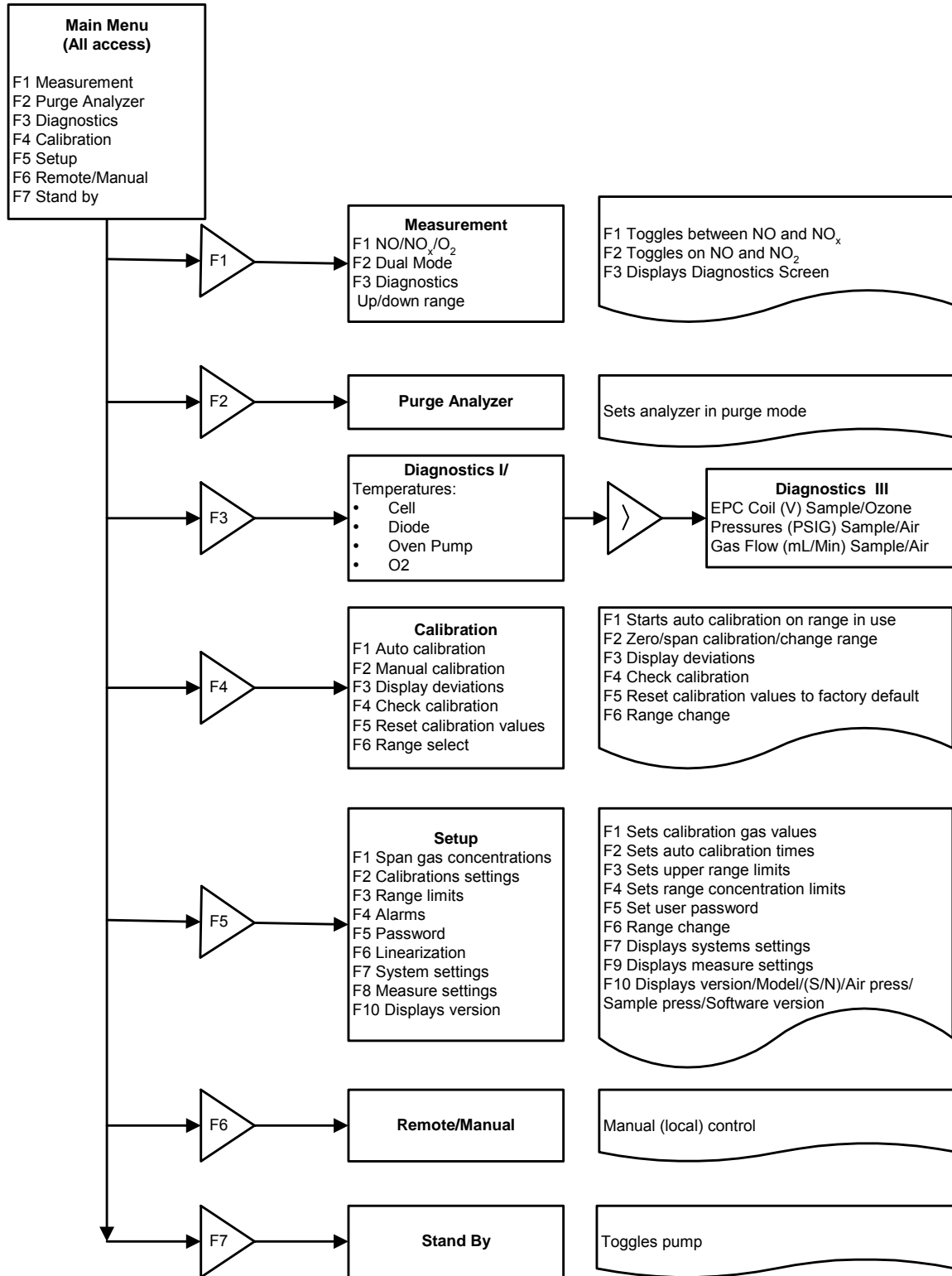

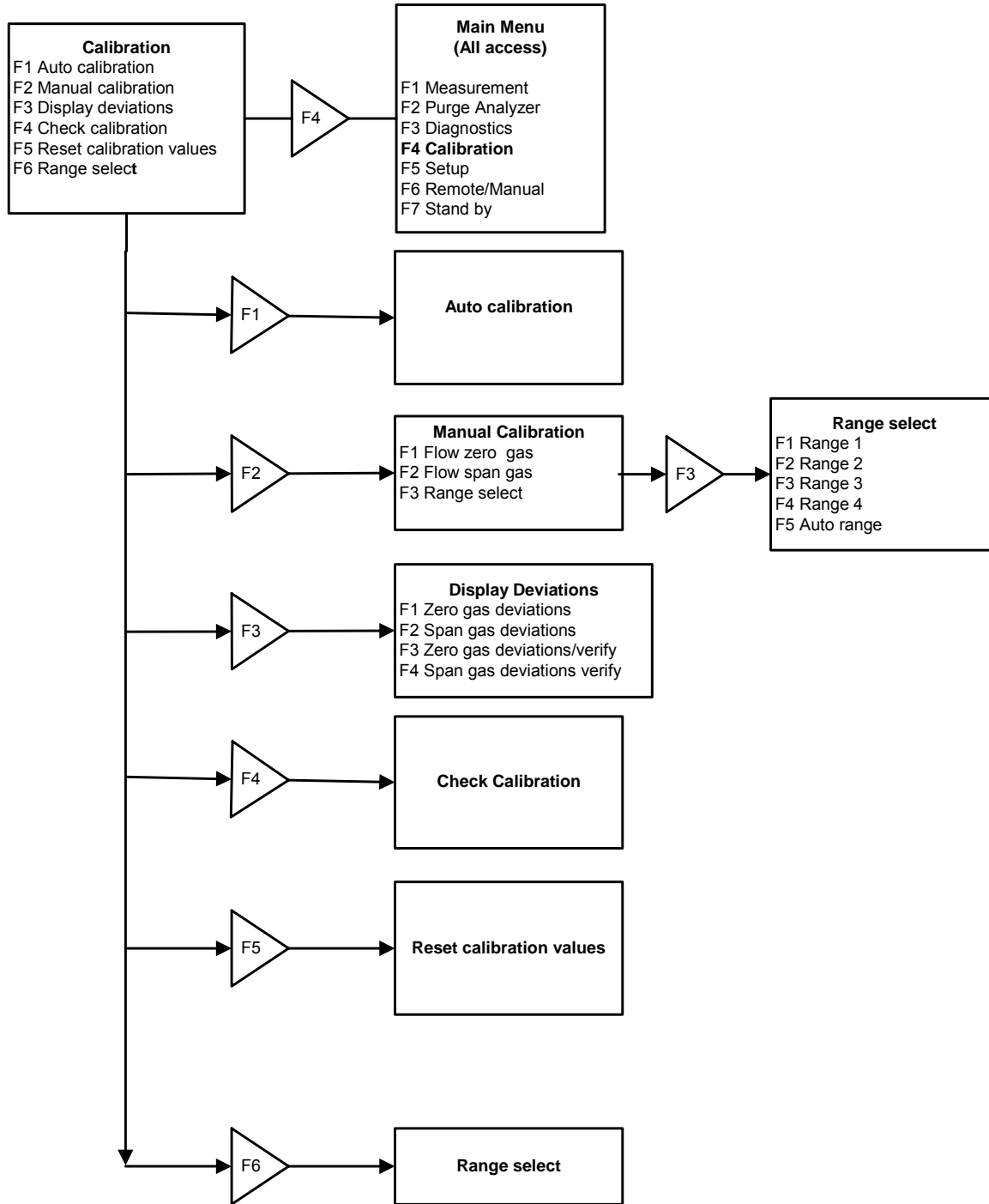

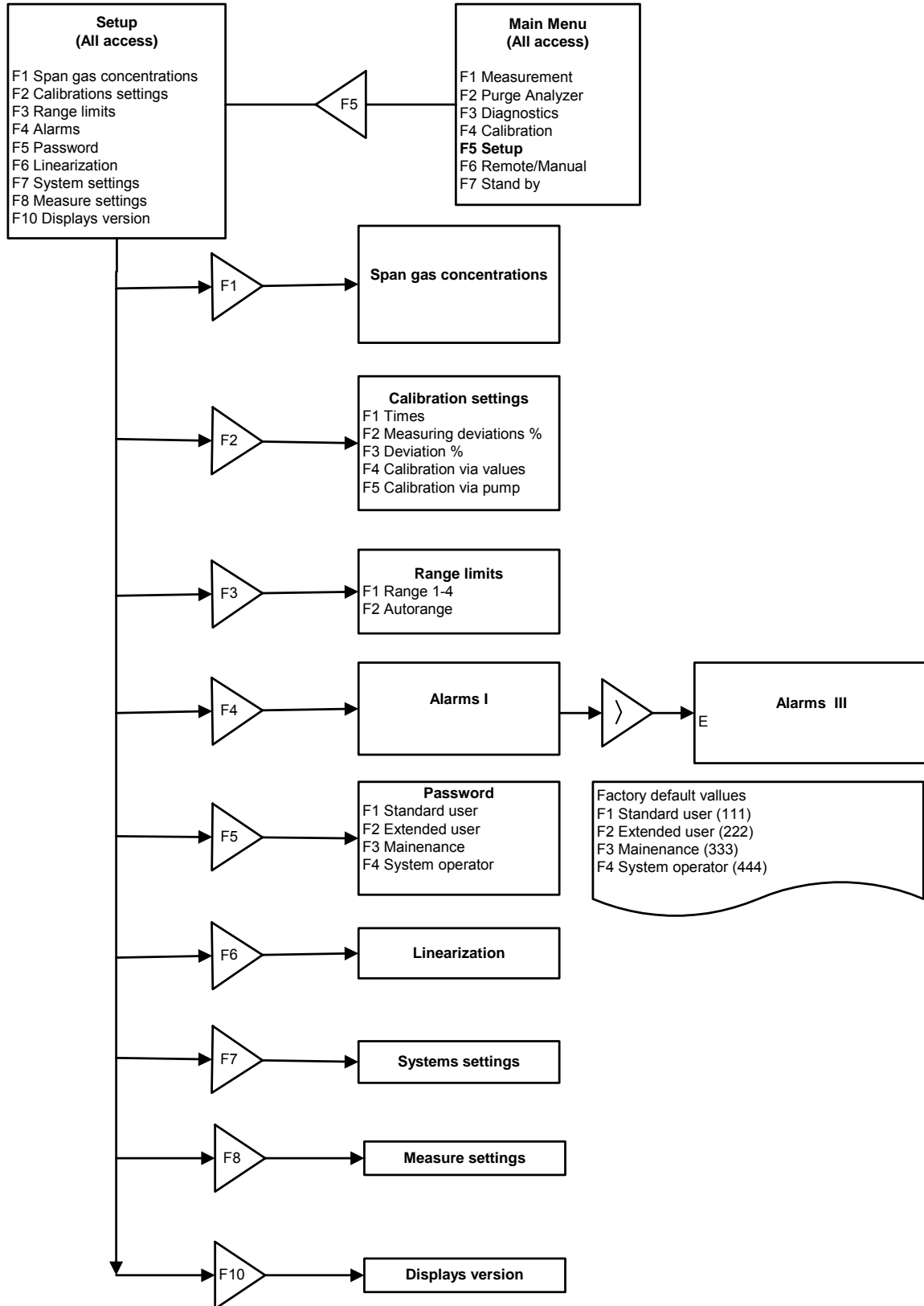

4.3. Keyboard

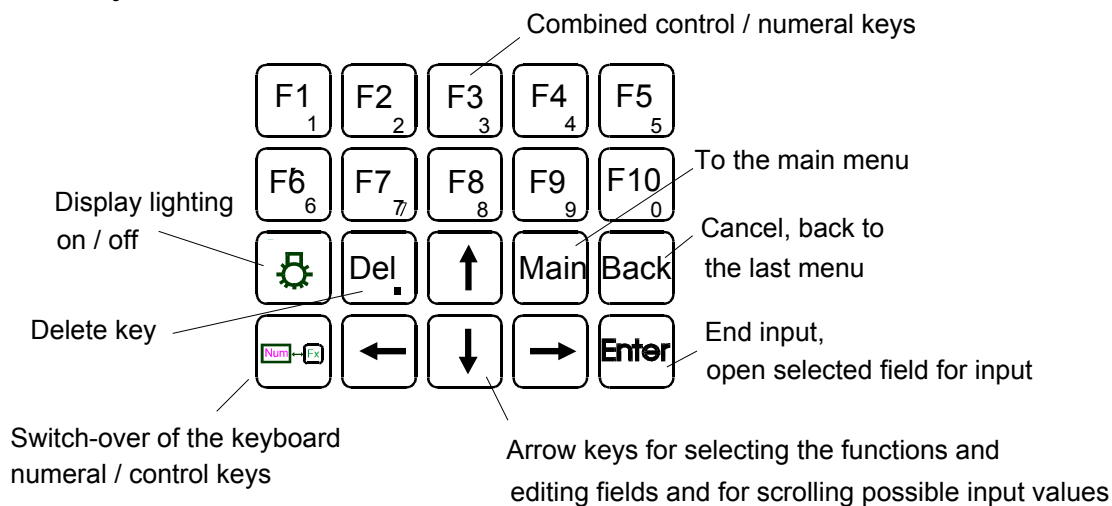

Figure 4-2 Keyboard

4.3.1. Operation with the Cursor Keys and the Enter Key

When operating the unit with the cursor keys, you select the various functions with the up/down cursor keys and start them with the Enter key. This method is particularly suitable for less proficient users since the system displays a short on-line help for nearly every function selected. The actual cursor position is shown as a black horizontal bar.

TIP: If you are not yet familiar with the screens and their fields, just press any cursor key after a screen appears. This moves the cursor from field to field and displays the corresponding online help.

4.3.2. Operation with the Function Keys

When using the function keys (F1 through F10), functions are directly accessed by pressing their corresponding function keys. This method is suitable for the advanced user since it is faster than the operation with the cursor keys.

4.3.3. Read/Change Parameters

To read and/or change parameters, you must switch to the parameter input mode by pressing the Enter key after calling the corresponding parameter screen. The input cursor (horizontal bar under the first character) then appears in the active edit field (black background). The cursor can be positioned with the right and left cursor keys, and the value displayed (number or letter) can be changed with the up and down cursor keys or entered directly. Every input has to be concluded by pressing the Enter key again, which causes the cursor to disappear.

5. Operating Structure

The analyzer's operation can be divided into four operating levels. The current level is always displayed as a stack of 1 to 4 horizontal bars in the top right corner of the screen. In the access level menu, you can choose between the following operating levels:

F1	User	(operating level 1)
F2	Advanced user	(operating level 2)
F3	Maintenance	(operating level 3)
F4	System user	(operating level 4)

A password can be assigned to each operating level. Only the system user, who normally has the highest operating priority, can assign the password. At the factory, the default passwords for the CAI analyzers are set as follows:

User:	111
Advanced user:	222
Maintenance:	333
System:	444

The default setting can be changed only by the system user. This manual is written to include all information for the advanced system user.

TIP: Because of the user settings, some of the parameters shown in this manual may not appear on your analyzer. Check the access level.

5.1. The Main Menu

Upon power up, the CAI logo is first displayed and then the main menu appears as below:

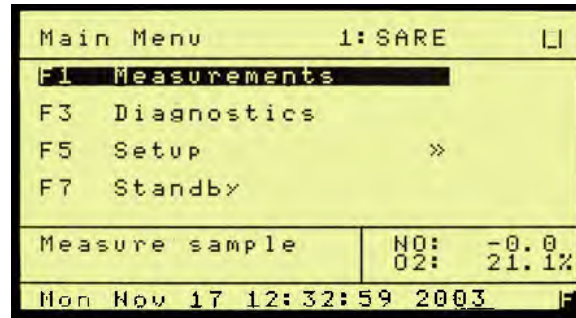

NOTE: Access Level Indication

Figure 5-1 Main Menu on Power Up Screen

NOTE: F6 is not available because, on initial start up, the analyzer reverts to ONLY Level 1 access. See Section 7.5.12 for setting Password information.

All functions can be selected with the cursor keys and activated by pressing the Enter key, or directly with the function keys F1 through F7. A ">" to the right of a function means that one or more sub-menus are available. If this sign is missing, the function starts immediately after the activation.

NOTE: Access level is 4.

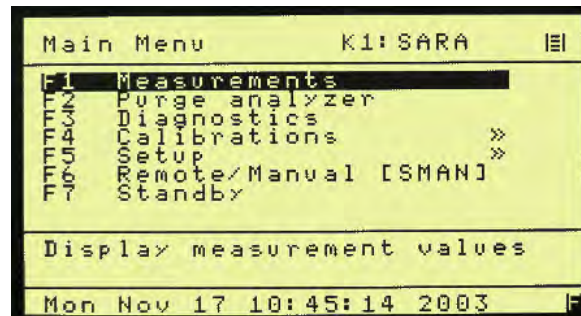

NOTE: Access Level Indication

Figure 5-2 Main User Menu (Level 4)

6. Menu Structure

There are 4 operating levels based on the level of your password. This section shows the access rights of the single levels.

6.1. User Functions (Level 1)

Main Menu		Setup Menu		Password Menu	
F1	Measurements	F5	Password	F1	Enter password
F2	Purge Analyzer	F10	Version		
F3	Diagnostics				
F4	Calibrations				
F5	Setup				
F7	Standby				

6.2. Advanced User Functions (Level 2)

Main Menu		Setup Menu		Password Menu	
F1	Measurements	F3	Range Limits	F1	Enter password
F2	Purge Analyzer	F5	Password		
F3	Diagnostics	F10	Version		
F4	Calibrations				
F5	Setup				
F7	Standby				

6.3. Maintenance Functions (Level 3)

Main Menu		Setup Menu		Password Menu		System Settings Menu	
F1	Measurements	F1	Span Gas Concentration	F1	Enter password	F1	Real Time Clock
F2	Purge Analyzer	F3	Range limits	F2	Reset password	F5	Status Line on/off
F3	Diagnostics	F5	Password	F7	Auto Startup		
F4	Calibrations	F7	System Settings				
F5	Setup	F8	Measure Settings				
F7	Standby	F10	Version				

6.4. System User Functions (Level 4)

All function described in this manual may be accessed from Level 4.

7. Main Menu Function Descriptions

7.1. F1 Measurements

The measurements screen is activated by pressing F1 on the Main Menu screen.

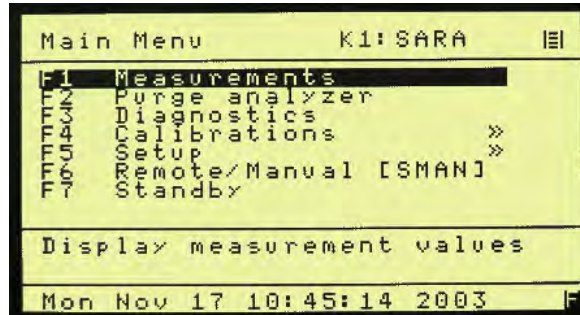

Figure 7-1 Main Menu Screen

7.1.1. F1 NO or NO_x Measurement

The NO/NO_x content is displayed in ppm. Pressing F1 switches between measuring the sample gas for NO_x or NO only. When the converter is off, only NO is measured. When the converter is on, NO_x is measured.

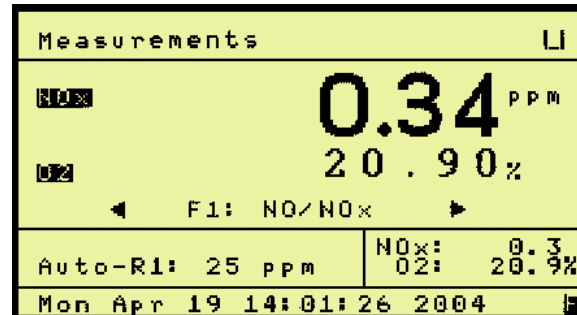

Figure 7-2 Measurements Screen

7.1.2. F2 NO + NO_x Measurement

The F2 function activates the “hold and sample” feature which allows the analyzer to automatically switch between NO and NO_x measurement. The time duration for the sample read is set up in the Setup Menu. The analyzer will read and display the NO (converter is bypassed) value. At the predetermined time, it will switch to the NO_x mode (through converter) and read and display the NO_x value, while the last 15 second NO average is displayed. The top value will be “real time” values and will change between NO and NO_x. The difference between the two average values is shown as NO₂. All three values are sent to the analog and digital outputs.

Measurements		LI
NO	0.33	ppm
NO	0.00	ppm
NO ₂	0.00	ppm
F1: NO/NO _x		
Auto-R1: 25 ppm	NO: 0.3	O ₂ : 20.9%
Mon Apr 19 14:01:04 2004		

Figure 7-3 Measurement Screen

7.2. F3 Diagnostics

F3 activates the diagnostic screen where pressures, flow rates, temperatures and EPC control voltages are displayed in real time. The units are psig, degrees C, ml/min. and voltage. Use the arrow key to switch between diagnostic screens.

Diagnostics I		LI
Temperatures:	Cell : 65.97	
[°C]	Diode : -5.00	
	Conv. : 203.49	
	Oven : 10.00	
	Pump : 10.00	
	O ₂ : 40.33	
page 1/2	NO: -0.0	
next screen▶	O ₂ : 21.0%	
Mon Nov 17 12:32:59 2003		

Figure 7-4 First Diagnostics Screen

Diagnostics II		LI
EPC Coil:	Sample: 6.92	
[V]	Ozone : 7.23	
Pressures:	Sample: 0.00	
[PSIG]	Air : 0.06	
Gas Flow:	Sample: 1.57	
mL/Min	Air : 24.56	
page 2/2	NO: -0.0	
◀previous page	O ₂ : 21.0%	
Mon Nov 17 12:32:59 2003		

Figure 7-5 Second Diagnostics Screen

7.3. Select Range

With the arrow keys, the ranges 1 to 4 can be selected and locked in which will disable the auto range capability. Continue pressing the arrow keys will recycle the analyzer back to auto range. The range and/or auto range is displayed on the measurement screen. If the limits are exceeded while not in the auto range mode, a warning "Over Range" appears on the screen.

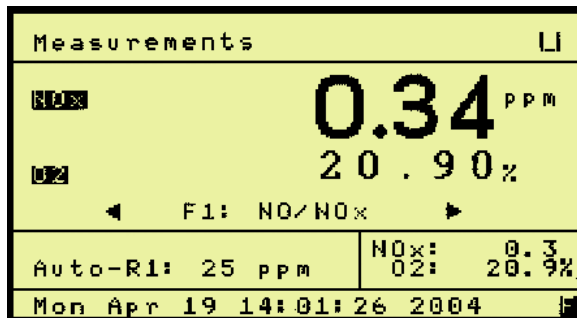

Figure 7-6 Set to Auto-Range

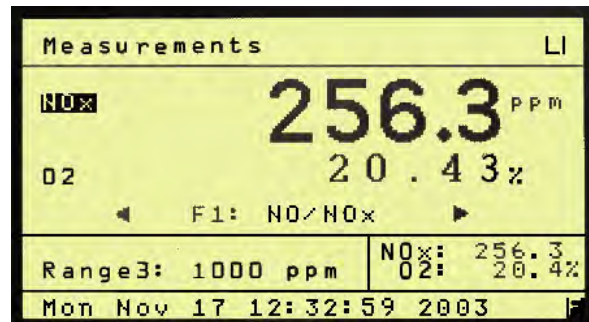

Figure 7-7 Analyzer set to Range 3

7.4. F2 Purge Analyzer

F2 from the Main Menu activates the Purge (analyzer) function if equipped.

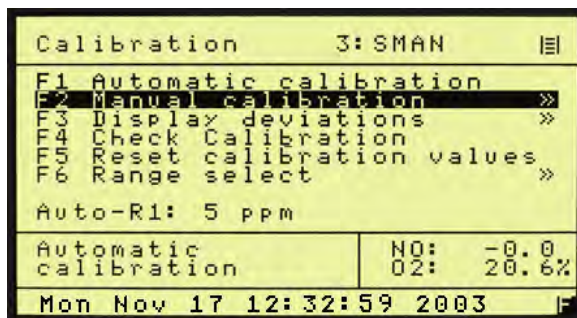

Figure 7-8 Main Menu (User Level 4)

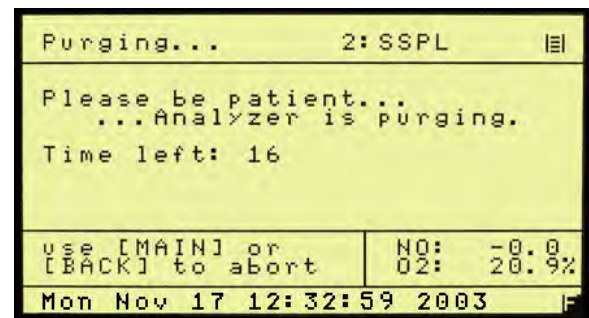

Figure 7-9 Purge Screen

Main Menu (User Level 4)

7.5. F3 Diagnostics

F3 from the Main Menu activates the Diagnostics function. As described in Section 7.1.3, F3 brings up the two diagnostics screens. The Diagnostics screens may be brought up from **EITHER** the Main Menu or the Measurements screen.

NOTE: Access level is 4.

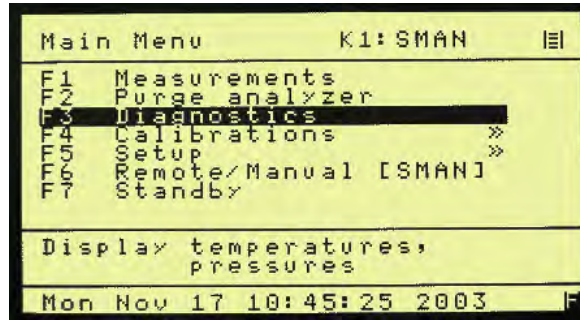

Figure 7-10 Main User Menu (Level 4)

7.6. F4 Calibrations

F4 from the Main Menu activates the Calibrations screen. Calibrations may be automatic or manual. Deviations can also be displayed. Calibration values can be reset to default values and the range to be calibrated can be changed.

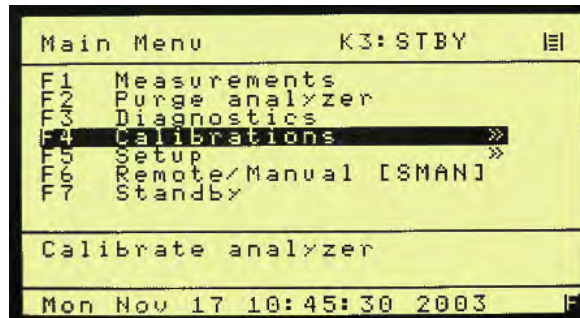

Figure 7-11 Main User Menu (Level 4)

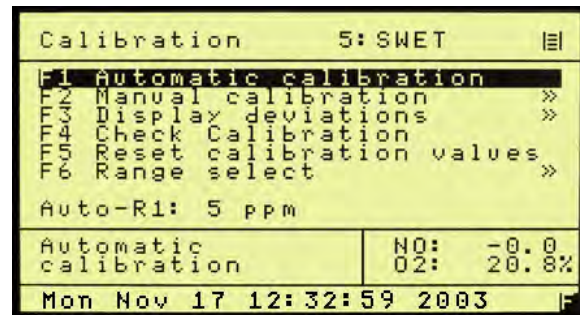

Figure 7-12 Calibration Screen (Level 4)

7.6.1. F1 Automatic Calibration

From the Calibrations screen, F1 starts automatic calibration. If auto range is selected, the actual range in use will be calibrated. Auto calibration works as follows: First zero gas is purged a certain time, called purge-time. Then the measurement begins. The measured value must be a minimum-time, called measuring-time and within an upper and a lower limit to be saved as new offset value. The maximum length of measuring time is 9 seconds. If the measured value was constant during calibration time, it is checked to determine if this value deviates from the preceding value. If the deviations are too large, a warning "Deviation error!" appears and the user can choose if the new value is saved or not. At last, the zero gas is flown a further time, verifying time, so it can be checked if the signal is still constant. All of these times can be changed. After zero gas calibration, the same happens with span gas. During auto calibration "Calibration in progress" is displayed. It also shows which gas is flowing and which time runs. When auto calibration has finished it is displayed. If the span value of the selected range is 0 (see section 5.6.1), then it will not be calibrated. If one range is calibrated and the span value for the lower ranges is zero, calibration parameters will be copied to this range. To calibrate all ranges with the same span gas, you must enter the gas concentration in the Span Gas Calibration screen for ALL RANGES. You must also calibrate each range. Offsets and scalars are NOT copied to other ranges.

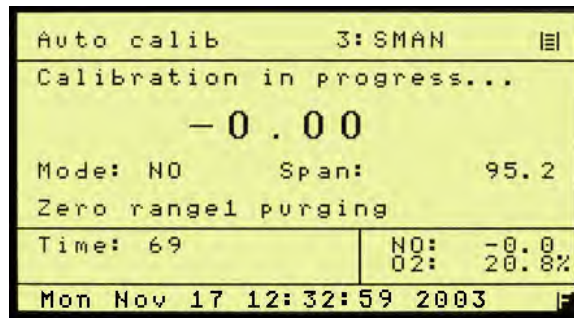

Figure 7-13 Auto Calibration Screen

7.6.2. F2 Manual Calibration

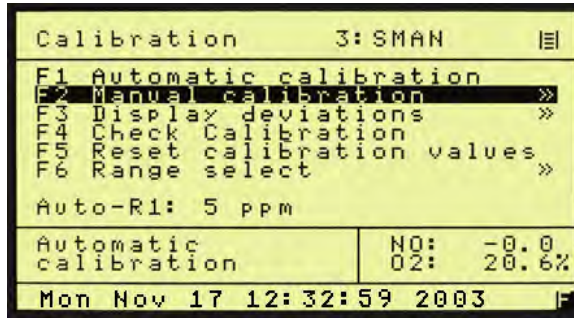

Figure 7-14 F2 Manual Calibration

From the Calibration screen, F2 starts manual calibration. If auto range is selected, calibration is not possible, and the appropriate range can be selected. In the manual calibrations menu, five options are possible:

- 1) F1 Flow zero gas
- 2) F2 Flow span gas
- 3) F3 Range select
- 4) F4 Flow zero O₂
- 5) F5 Flow span O₂

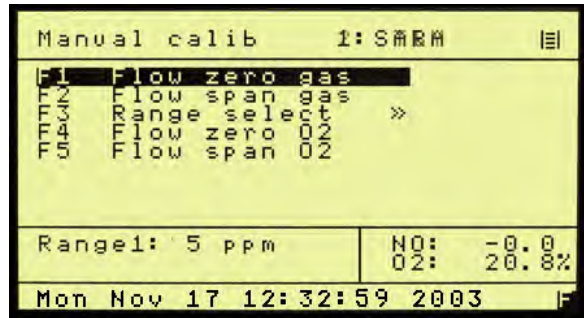

Figure 7-15 Manual Calibration Screen

When zero or span gas is flown, the measured value can be saved by pressing F1. If the screen is left by pressing the buttons "Main" or "Back", the measured value is not saved. Solenoids are closed by pressing F2.

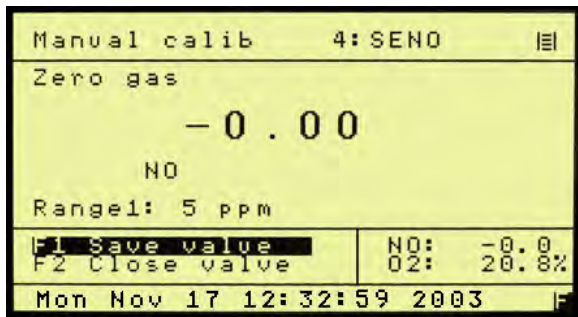

Figure 7-16 Manual zero gas calibration

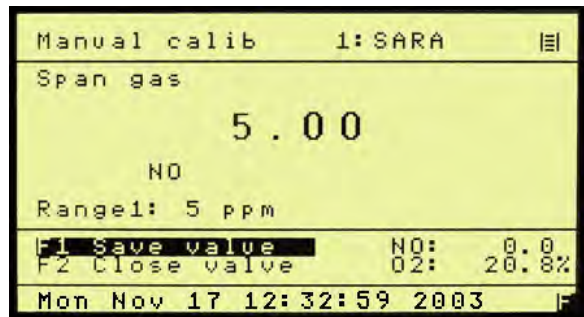

Figure 7-17 Manual Span gas calibration

From the manual calibration menu, the range to calibrate can be chosen by pressing F3.

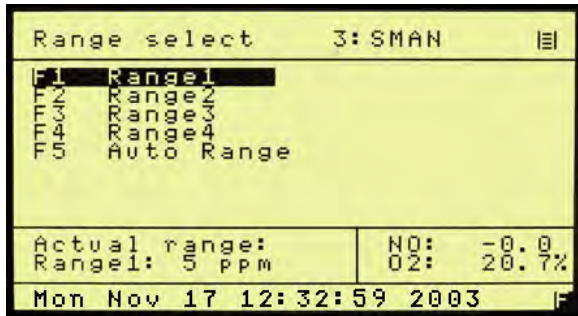

Figure 7-18 Range select

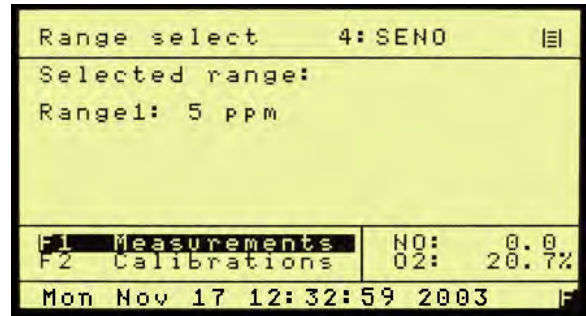

Figure 7-19 Selected range 1

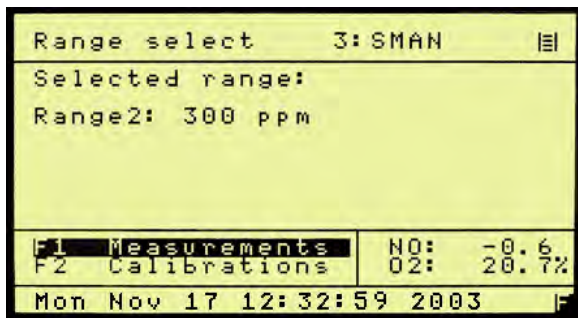

Figure 7-20 Selected range 2

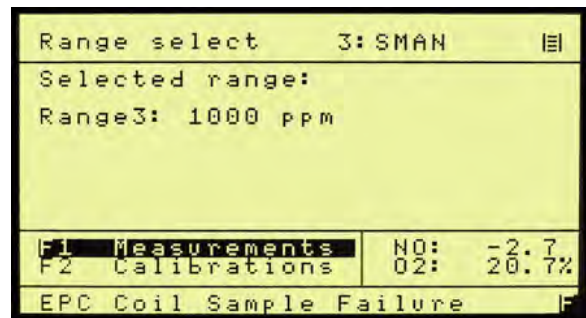

Figure 7-21 Selected range 3

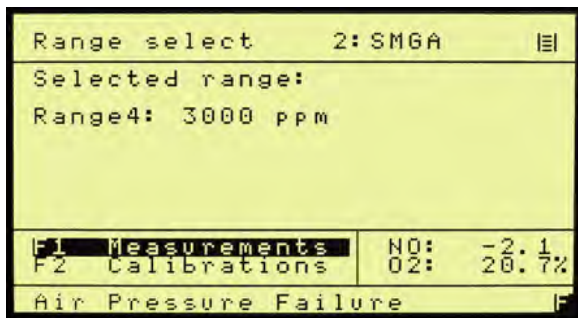

Figure 7-22 Selected range 4

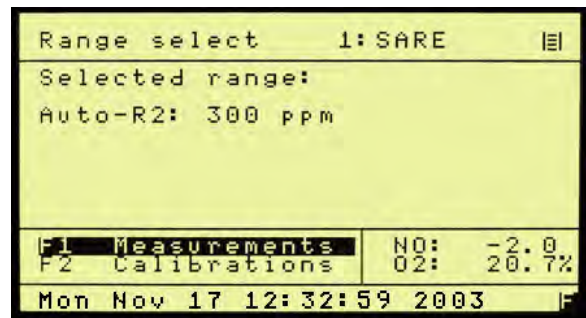

Figure 7-23 Selected auto range

7.7. F3 Display Deviations

Calibration		3: SMAN	⏏
F1	Automatic calibration		
F2	Manual calibration	>>	
F3	Display deviations	>>	
F4	Check Calibration		
F5	Reset calibration values		
F6	Range select	>>	
Auto-R1: 5 ppm			
Automatic calibration		NO: -0.0	O2: 20.6%
Mon Nov 17 12:32:59 2003			

Figure 7-24 F3 Display deviations

After every calibration, the deviations are calculated for zero and for span gas.

- 1) F1 shows zero gas deviations
- 2) F2 shows span gas deviations
- 3) F3 Deviations of zero gas during verifying
- 4) F4 Deviations of span gas during verifying

Display devs		5: SWET	⏏
F1	Zero gas deviations		
F2	Span gas deviations		
F3	Verifying devs. zero		
F4	Verifying devs. span		
Display zero gas deviations		NO: 1.1	O2: 20.6%
Mon Nov 17 12:32:59 2003			

Figure 7-25 Display deviations screen

F1 and F2 deviations are displayed in percent.

During calibration there is verification for zero and span gas. With option F3 and F4 you can view the deviations during the verification time. Absolute deviation is the absolute average difference from the saved value in ppm. Relative deviation is the absolute average difference in percent, related to the range limit.

7.7.1. Absolute Zero Gas Deviation

Absolute zero gas deviation is zero gas content calculated by the factory polynomial related to the range limit of the calibrated range.

Zero gas devs 1: SARE		
Zero gas deviations [%]:		
	abs	rel
Range1:	-6.65	-2.52
Range2:	0.11	0.10
Range3:	0.25	0.02
Range4:	0.07	0.02
		NO: -0.0
		O2: 20.6%
Mon Nov 17 12:32:59 2003		

Figure 7-26 Zero gas deviations

Zero gas devs 2: SMGA			
Zero gas devs. verifying			
	measured values	abs deviations	rel
Range1:	0.0	0.00	0.00
Range2:	0.0	0.00	0.00
Range3:	0.0	0.00	0.00
Range4:	0.0	0.00	0.00
		NO: 0.0	
		O2: 20.6%	
Mon Nov 17 12:32:59 2003			

Figure 7-27 Zero gas deviations verifying

7.7.2. Relative Zero Gas Deviation

Relative zero gas deviation is the actual deviation minus the deviation of the previous calibration related to the range limit of the calibrated range.

7.7.3. Absolute Span Gas Deviation

Absolute span gas deviation is span gas bottle value minus span gas value calculated by the factory-polynomial related to the range limit of the calibrated range.

Zero gas devs 2: SMGA			
Zero gas devs. verifying			
	measured values	abs deviations	rel
Range1:	0.0	0.00	0.00
Range2:	0.0	0.00	0.00
Range3:	0.0	0.00	0.00
Range4:	0.0	0.00	0.00
		NO: 0.0	
		O2: 20.6%	
Mon Nov 17 12:32:59 2003			

Figure 7-28 Span gas deviations

Span gas devs 3: SMAN			
Span gas devs. verifying			
	measured values	abs deviations	rel
Range1:	0.0	0.00	0.00
Range2:	0.0	0.00	0.00
Range3:	0.0	0.00	0.00
Range4:	0.0	0.00	0.00
		NO: 0.0	
		O2: 20.6%	
Mon Nov 17 12:32:59 2003			

Figure 7-29 Span gas deviations verifying

7.7.4. Relative Span Gas Deviation

Relative span gas deviation is the actual deviation minus the deviation of the previous calibration related to the range limit of the calibrated range.

7.7.5. F4 Check Calibration

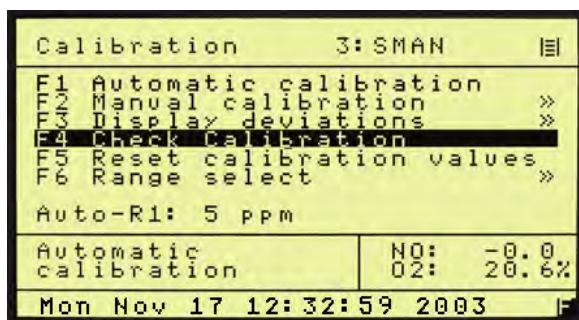

Figure 7-30 F4 Check calibration

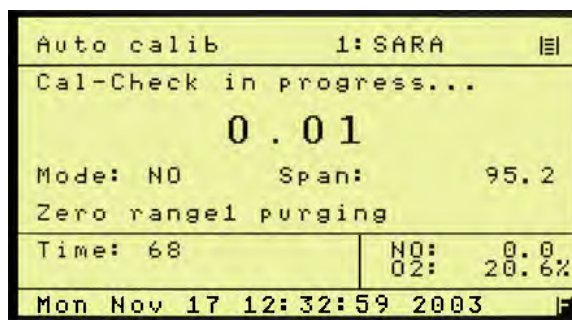

Figure 7-31 Check Calibration

There is a default calibration. Pressing F4, activates an automatic zero and span check for verification.

7.7.6. F5 Reset Calibration Values

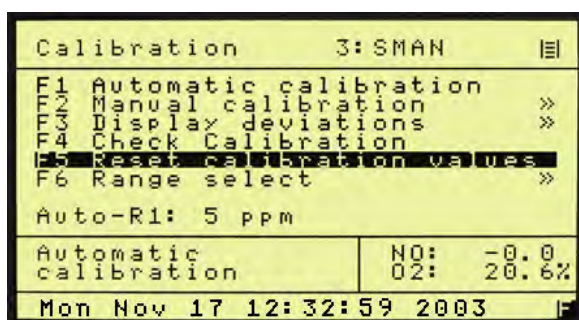

Figure 7-32 F5 Reset calibration values

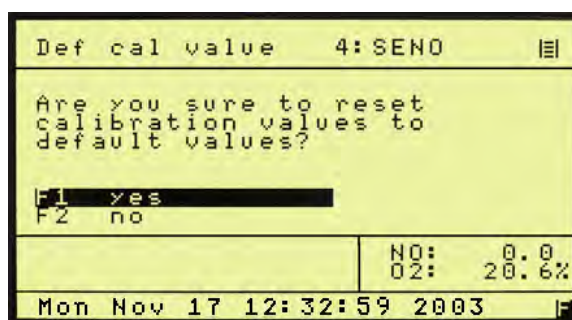

Figure 7-33 Reset calibration values

There is a default calibration. Pressing F5, a new screen appears and asks if the user is sure to reset calibration values to the default calibration values. F1 confirms and the calibration values are reset to default calibration values. F2 leaves this menu without resetting to default values. This function will overwrite all calibrations with factory values. Also the linearization polynom will be overwritten with the factory values.

7.7.7. F6 Range Select

This allows a range change to be activated from the calibration menu.

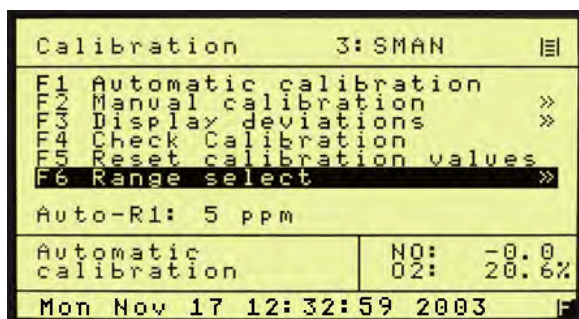

Figure 7-34 Range Select

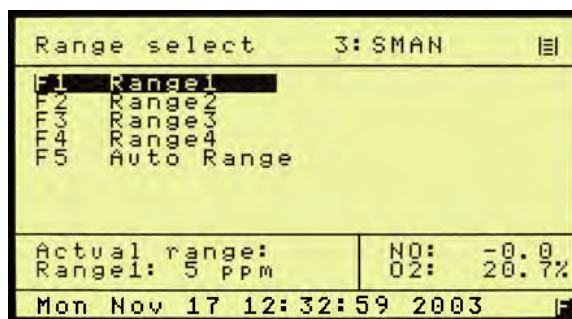

Figure 7-35 Range

7.8. F5 Setup

From the Main Menu, F5 brings up the setup menu. Span gas concentrations, calibration settings, range limits, alarms, password, linear ization, system and measure settings can be changed. The Setup menu begins as shown below. A description of each parameter is shown in the information box. NOTE: Use the down arrow key to obtain the additional setup parameters.

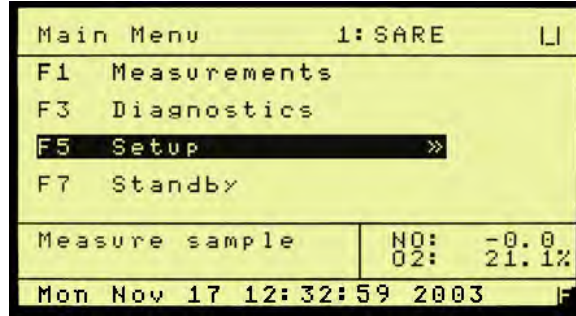

Figure 7-36 Main menu (User level 4)



Figure 7-37 Setup menu 1

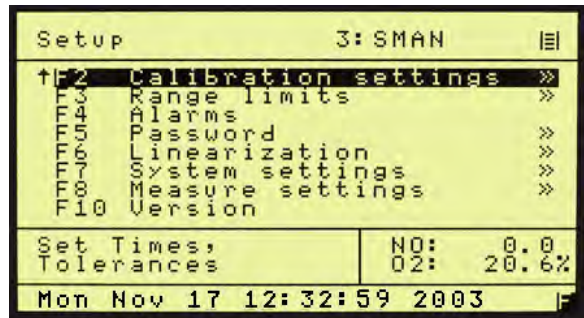

Figure 7-38 Setup menu 2

7.8.1. F1 Span Gas Concentration

For calibration, it is necessary to input the concentration of the span gas in ppm. For every range, the span gas concentration can be changed. After pressing F1 in the setup menu, a screen appears in which changes can be made. Select with the cursor buttons the range to change. The selected field turns black. To change parameters, switch to parameter input mode by pressing the Enter key. The input cursor (horizontal bar under the first character) then appears in the active edit field (black background). The cursor can be positioned with the right and left cursor keys, and the value displayed (number or letter) can be changed with the up and down cursor keys or entered directly. Every input has to be concluded by pressing the Enter key again. Then the input cursor disappears and a new range can be selected. The changes are saved by leaving the screen by pressing "Main" or Back". At the right side of the screen, the range limits of the 4 ranges are displayed. They cannot be changed in this screen.

Setup		5: SWET	⏏
Span gas conc. range limits			
Range1:	95.200	5	
Range2:	270.000	300	
Range3:	1000.000	1000	
Range4:	3000.000	3000	
02:	21.000		
		NO: 0.0	
		O2: 20.6%	
Mon Nov 17 12:32:59 2003			

Figure 7-39 Change span gas settings

7.8.2. F2 Calibration Settings

In the calibration settings menu, times, deviations and methods can be changed.

Setup		4: SEN0	⏏
F1 Times			
F2	Measuring deviations		
F3	Deviations		
F4	Calib. via valves		
F5	Calib. via probe		
Change automatic calib. times		NO: 0.0	
		O2: 20.5%	
Mon Nov 17 12:32:59 2003			

Figure 7-40 Change Auto Calibration Settings

7.8.3. F1 Times

There are four times (in seconds) for auto calibration that can be changed. Purge, measuring, calibration and verifying time. Changes are made and saved as above.

Setup		3: SMAN	⏏
Auto calibration times [sec]			
Purge	:	10	
Measuring	:	10	
Calibration	:	40	
Verifying	:	10	
Purge after	:	10	
		NO:	0.0
		O2:	20.5%
Mon Nov 17 12:32:59 2003			

Figure 7-41 Setup-times

7.8.4. F2 Measuring Deviations

During auto calibration, the measured value is only saved if it is within a certain time within an upper and a lower limit. These two limits format a working window. In the setup menu the deviation is in percent.

Setup		5: SWET	⏏
Measuring deviation [%]			
Range 1:	:	2.00	
Range 2:	:	2.00	
Range 3:	:	2.00	
Range 4:	:	2.00	
		NO:	0.0
		O2:	20.5%
Mon Nov 17 12:32:59 2003			

Figure 7-42 Measuring deviations

7.8.5. F3 Deviations

Here you can change absolute and relative deviation in percent. After auto calibration, it is checked to assure the deviations are within this limit. If the deviations are not in this limit, a warning "Deviation error!" appears.

Setup		1: SARA	⏏
Deviations [%]			
		absolute	relative
Range 1:	:	10.00	10.00
Range 2:	:	10.00	10.00
Range 3:	:	10.00	10.00
Range 4:	:	10.00	10.00
		NO:	0.0
		O2:	20.5%
Mon Nov 17 12:32:59 2003			

Figure 7-43 Absolute versus relative deviations

7.8.6. F4 Calibrations via Solenoids

Calibrations can be made by using the solenoids for zero and span gas or by using the pump. Calibration via valves means that the zero gas is flown by the zero gas solenoid and the span gas is flown by the span gas solenoid.

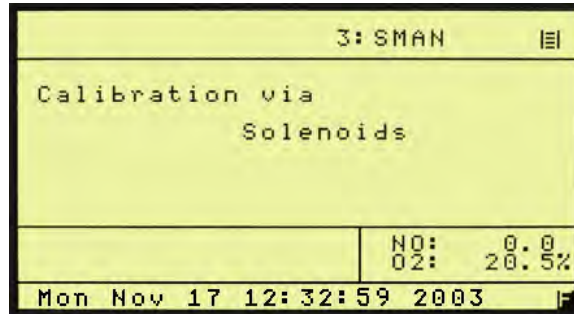

Figure 7-44 Calibrations via internal solenoid valves

7.8.7. F5 Calibration via Probe

Calibration via probe means that the zero and the sample gas is flown by the sample pump, the solenoids for zero and span gas are not used.

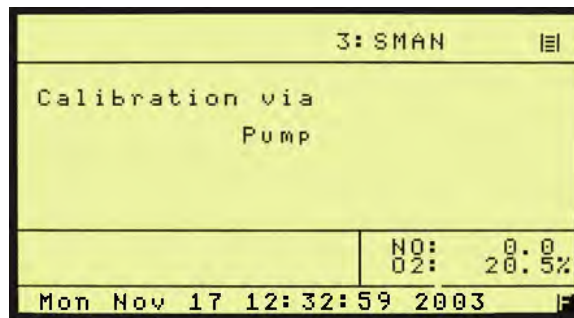

Figure 7-45 Calibration via probe

7.8.8. F3 Range Limits

There are 4 different ranges. The user can define the upper range limits in ppm.

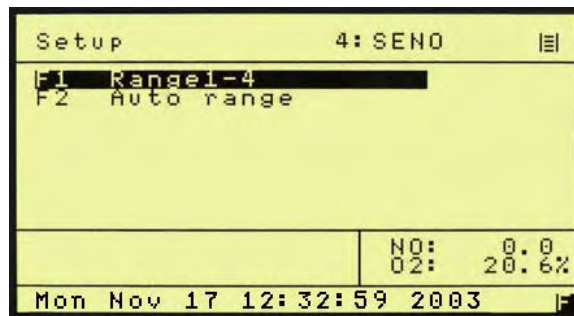

Figure 7-46 Change Range Limits

7.8.9. F1 Range 1-4 (Change Upper Range Limits)

In this menu the upper range limits can be changed. The new settings are saved by pressing MAIN or BACK. The auto range limits are automatically adapted. This means that if the upper range limit of range 1 for example has reached 90% of the upper range limit in the auto range mode, it is switched automatically to the second range.

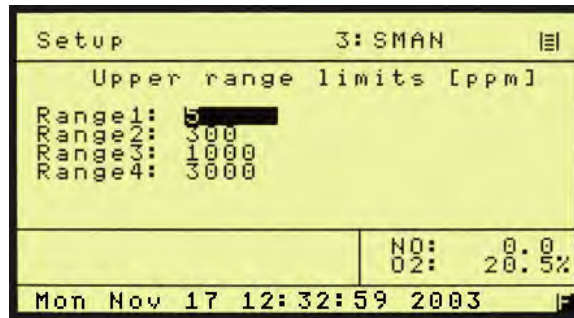

Figure 7-47 Change Upper Range Limits

7.8.10. F2 Change Auto Range Limits

Although the auto range limits are adapted automatically, it is possible to define them manually. Up means the value when the next higher range is selected in auto range mode, down the value when the next lower range is selected.

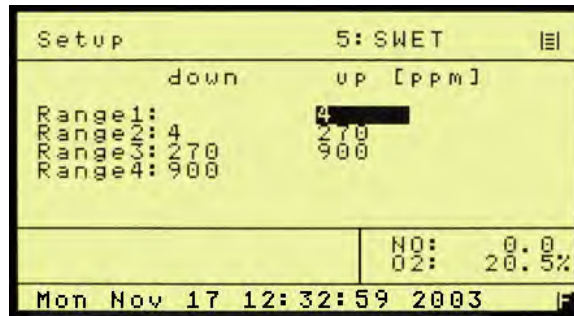

Figure 7-48 Change Auto Range Limits

7.8.11. Alarms

Error reports are always displayed in the lowest line of the screen. There are two pressures, three temperatures, one concentration and two voltages with alarm limits that can be defined. The user can define the range limits and, if exceeded, will display an error-message.

Alarms I		1: SARA			
-Temps:	Cell :	Min	65.00	Max	67.00
	[°C]		-5.50		-4.50
	Diode:		204.00		207.00
	Conv.:		65.00		67.00
	Oven :		65.00		67.00
	Pump :		65.00		67.00
	O2 :		1.00		5.00
page 1/2		NO:		0.0	
F1 - next page		O2:		20.5%	
Mon Nov 17 12:32:59 2003					

Figure 7-49 Set Temperature Alarms

Alarms II		1: SARA			
-Conc. alarms:		Min	300	Max	750
-Press:	Sample		3.82		3.88
	[PSIG]	Air	14.00		16.00
-EPC:	Sample		1.00		6.00
	[V]	Air	1.00		5.00
page 2/2		NO:		0.0	
F1 previous page		O2:		20.5%	
Mon Nov 17 12:32:59 2003					

Figure 7-50 Set Concentration, Pressure and Voltage Alarms

7.8.12. Password

After turning on the analyzer, you are in access level 1. To change the access level or to change the passwords, press F5 (Setup) in the main menu and Press F5 (Password) again. The following screen appears:

Setup		1: SARA			
F1	Enter password				
F2	Change password				
F3	Reset passwords				
Enter password		NO:		0.0	
		O2:		20.5%	
Mon Nov 17 12:32:59 2003					

Figure 7-51 Enter / Change Password

7.8.13. F1 Enter Password

To change access level, press F1. The following screen appears:



Figure 7-52 Access Level Screen

F1 to F4 selects an access level. Move the cursor to the access level to be modified. You must enter the correct password for the access level desired. The passwords for the various operation levels consist of three numbers that must be entered on the numeric keypad. If the code word is incorrect, you are asked to re-enter the codeword.

IMPORTANT TIP: *When a new analyzer is powered up, it defaults to access level 1 (User). To operate ALL parameters and gain complete access, select F4. Press the Enter key twice and enter 444.*

7.8.14. F2 Change Password

The passwords can only be changed, if you are in access level 4. After F2, enter your new 3 digit passwords.

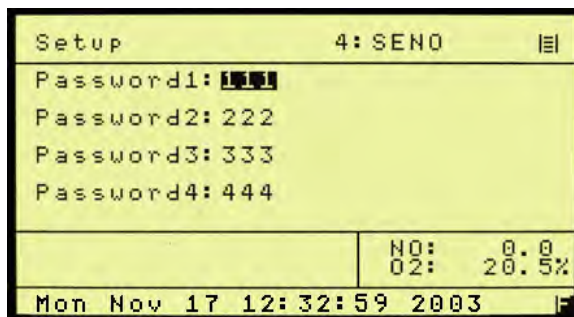

Figure 7-53 Passwords

IMPORTANT TIP: *You MUST remember and record this new password. If this is lost, you will need to consult the factory for the default password!*

7.8.15. F3 Reset Passwords

The passwords can only be changed, if you are in access level 4. Reset passwords will revert back to the factory defaults.

7.8.16. Linearization

Pressing F6 on the Setup screen brings up the Linearization screen. The analyzer can be linearized by a polynomial with 5 coefficients. By pressing F1, these 5 coefficients can be changed for each range. By pressing F2, the raw value can be displayed. This is the value before linearization and offset span correction. There are two values on the screen: The value at the top is the linearized, offset-span-corrected value, and the other value is the raw-value.

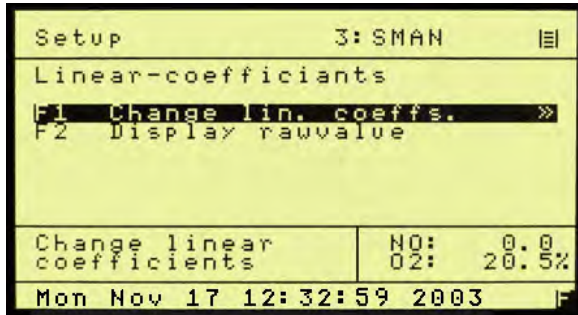

Figure 7-54 Linearization Screen

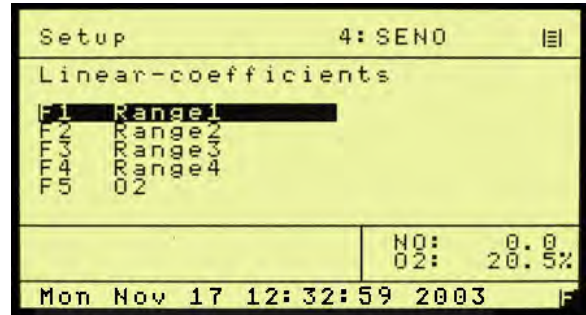

Figure 7-55 Coefficients Range Select



Figure 7-56 Linearization Coefficients

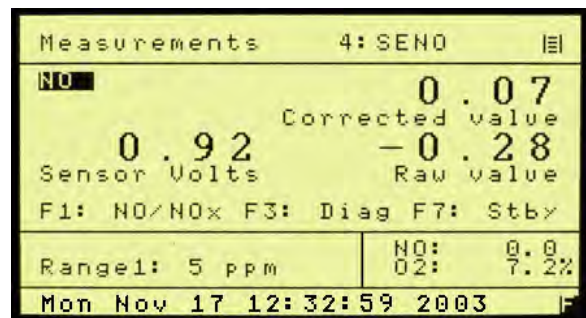

Figure 7-57 Range Raw Data with F2

7.8.17. F7 System Settings

This screen allows all the system settings to be displayed and modified.



Figure 7-58 system settings



Figure 7-59 System Setup Screen

7.8.18. F1 Real Time Clock

This brings up the clock time set screen; auto cal and auto cal enable screens.



Figure 7-60 Clock and Timing Setup Screen

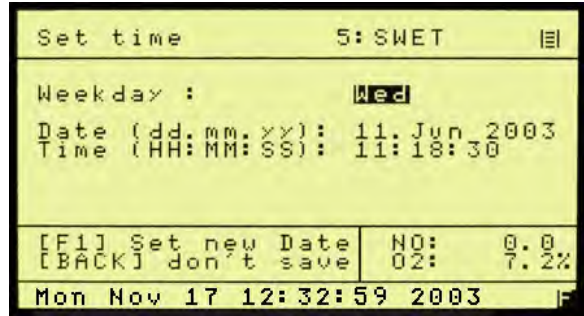

Figure 7-61 Set Clock Screen

F1 brings up the clock set screen

The current time may be set by using the cursor to highlight the entry and using the numeric keys to change the values.

7.8.19. F2 Set autocalibration time

F2 brings up the autocalibration time set. As above, the date and times can be set by using the cursor to highlight the entry and using the numeric keys to change the values.

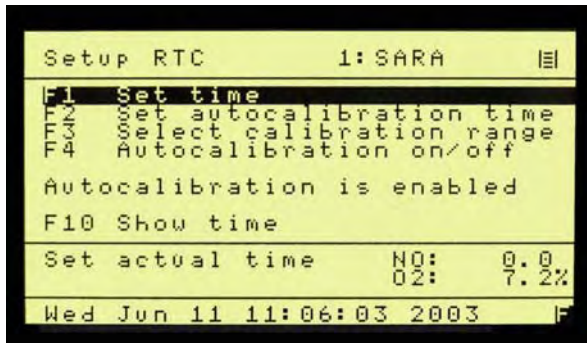

Figure 7-62 Select autocalibration time



Figure 7-63 Set Autocalibration Cal Timing

7.8.20. F3 Set Auto Cal Ranges

Setup RTC	1: SARA	
F1	Set time	
F2	Set autocalibration time	
F3	Select calibration range	
F4	Autocalibration on/off	
Autocalibration is enabled		
F10	Show time	
Set actual time	NO:	0.0
	O2:	7.2%
Mon Nov 17 12:32:59 2003		

Figure 7-64 Clock and Timing Setup Screen

7.8.21. F4 Autocalibration on/off

Setup RTC	2: STBY	
F1	Set time	
F2	Set autocalibration time	
F3	Select calibration range	
F4	Autocalibration on/off	
Autocalibration is disabled		
F10	Show time	
enable/disable autocalibration	NO:	0.0
	O2:	7.2%
Mon Nov 17 12:32:59 2003		

Figure 7-65 F4 Toggles Auto Cal ON of OFF

7.8.22. Auto calibration

Displays system time and status of autocalibration.

Actual time	5: SWET	
System time :		
Wed Jun 11 11:20:08 2003		
Next autocalibration :		
autocalibration off		
use [BACK] or [MAIN] key	NO:	0.0
	O2:	7.2%
Mon Nov 17 12:32:59 2003		

Figure 7-66 Autocalibration Status

7.8.23. F2 Displays TCP/IP Address

TCP/IP setup		3: SMAN	⊞
IP-address:	192.000.000.246		
Netmask :	255.255.255.000		
Port :	7700		
GateWay :	255.255.255.000		
WinifPort:	2000		
HWaddress :	00.E0.4B.01.9D.F5		
Reboot for new settings	NOx:	255.4	
	O2:	20.3%	
Mon Nov 17 12:32:59 2003			

Figure 7-67 TCP/IP Address

7.8.24. F3 Displays Output Signal Assignments
(Used to Adjust Analog Output Channels)

assignment		5: SWET	⊞
Output	Signal	Error on AOut	
1	RealTime	On	
2	02		
3	RealTime		
4	02		
		NOx:	255.3
		O2:	20.4%
Mon Nov 17 12:32:59 2003			

Figure 7-68 Output Assignments

7.8.25. F4 Displays Output Ranges
(Used to Adjust Scale of Analog Output Channels)

output ranges		5: SWET	⊞
Output	lower	Limit upper	Mode
1	4	21	mA
2	4	20	mA
3	0	0	mA
4	0	0	mA
0 in both fields use default range		NOx:	255.1
		O2:	20.3%
Mon Nov 17 12:32:59 2003			

Figure 7-69 Output Ranges

7.8.26. F5 Turns Status Line On or Off

The status line displays the AK Protocol action on the top line of the display.



Figure 7-70 Status Line

7.8.27. F8 Measure Settings

This screen allows several of the system settings to be displayed and modified.

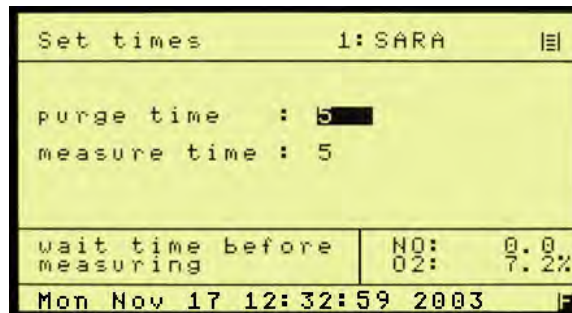

Figure 7-71 Menu Settings Screen

7.8.28. Set NO₂ Mode TimesFigure 7-72 Set NO₂ Purge and Measure Time

7.8.29. F2 Converter Efficiency

F2 on the Menu Settings screen allows the NO to NO₂ converter efficiency to be set to the actual measured converter efficiency. A value of 100% equals 1.00. F2 will prompt the operator through the NO_x efficiency test using a NO_x generator.

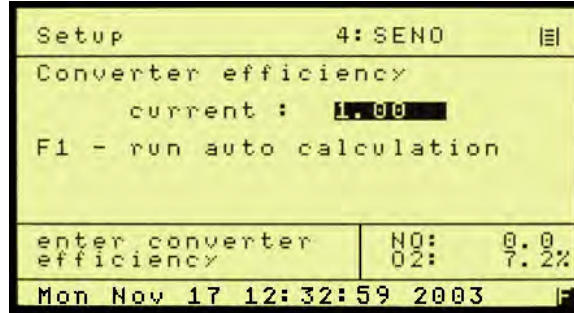

Figure 7-73 Set Converter Efficiency

7.8.30. Low Pass Filter Time Constant

F3 on the Menu Settings screen allows the software time constant to be set between 1 and 60 seconds. This is very useful in eliminating noise when measuring low level concentrations.

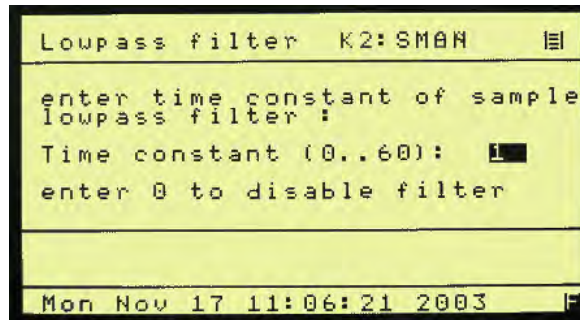

Figure 7-74 Set Time Constant

7.8.31. F4 Purge Time

F4 on the Menu Settings screen sets the purge time before continuing with a zero or span calibration.

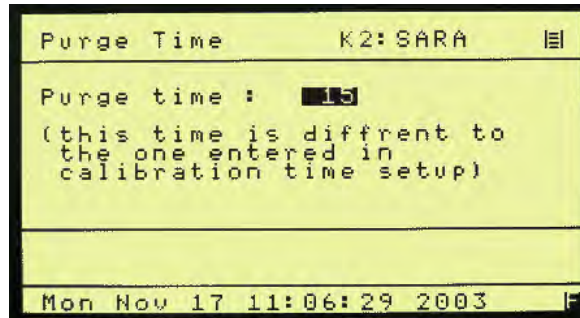

Figure 7-75 Set Purge Time

7.8.32. F10 Displays the Current Analyzer and Software Versions

This displays the analyzer's information, including the factory recommended air and sample pressure settings.

```
Version |  
-----  
      Model :  
          S/N :  
Sample pres.:  
          Software version >  
-----  
Mon Jan 01 01:11:28 2003 |
```

Figure 7-76 Analyzer Information Version

```
Version |  
-----  
      3MAIN : 1.008  
      3USER : 1.326  
      OSMSR : 2.156  
-----  
< Device info  
-----  
Mon Jan 01 01:11:32 2003 |
```

Figure 7-77 Software Version

7.9. F7 Remote / Manual Control

The analyzer can be remote-controlled by either a master computer or via contact closures. The TCP/IP and serial communication fully corresponds to the specifications of the AK protocol. To change remote/manual control, press F6 in the main menu. This toggles between remote and manual control.

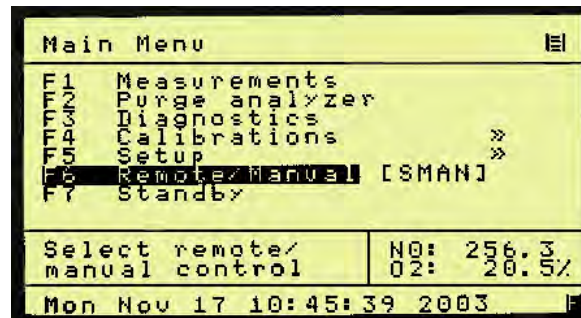

Figure 7-78 Remote manual control

Main Menu (User Level 4)

7.10. F8 Standby

In Standby mode, pump is turned off and the solenoids are closed. The CAI logo is displayed.



Figure 7-79 Standby selection

Main Menu (User Level 4)

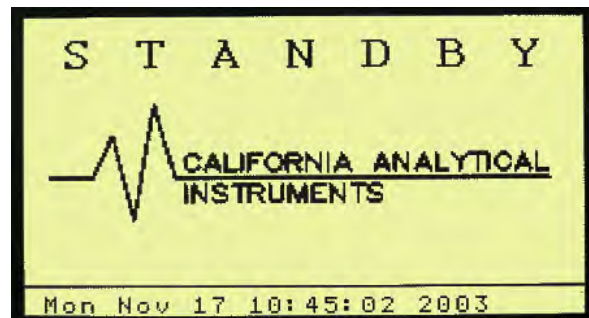

Figure 7-80 Standby screen

8. Analyzer Components

8.1. Rear Panel

The following details the rear panel connections:

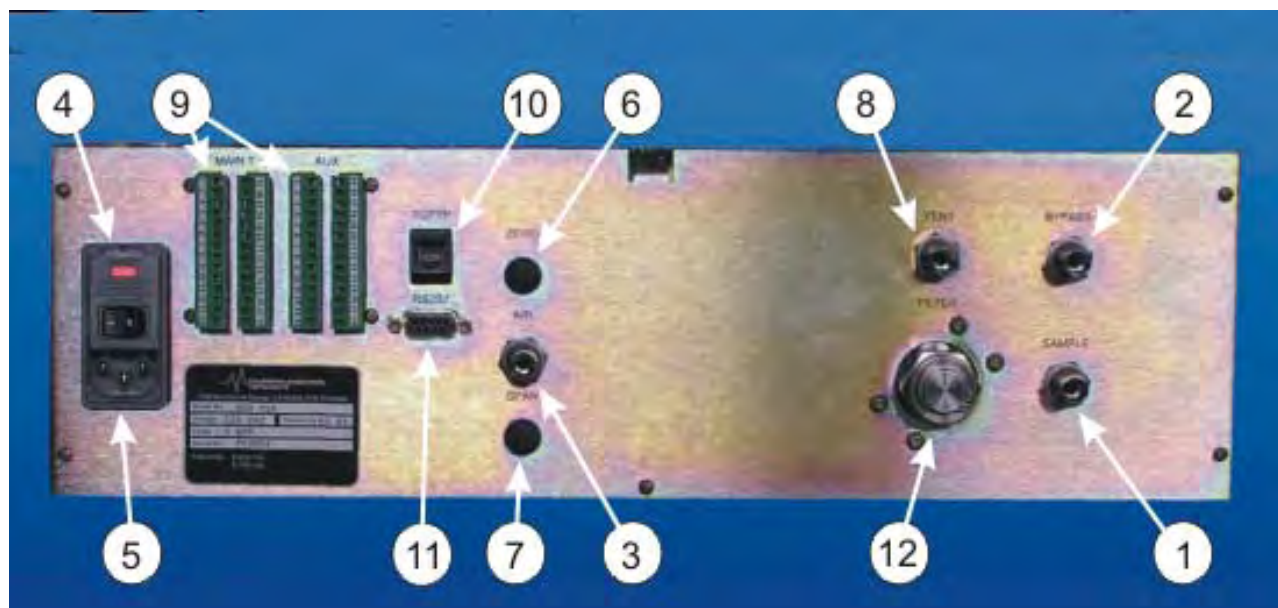

Figure 32: Rear Panel

- 1) Sample Gas Inlet: Feeds sample gas to the analyzer. ¼ Inch Tube.
- 2) Sample Gas Bypass Outlet: Exhaust for sample. ¼ Inch Tube.
- 3) Air Inlet: For feeding hydrocarbon free air or oxygen to the ozone generator.
- 4) Power Entry Module: Power connection, power switch, fuse compartment (2 Amp).
- 5) Rear Panel Power ON/OFF Switch: Turns ON/OFF line power to instrument.
- 6) Zero Gas Inlet: For feeding hydrocarbon free zero air to the analyzer. (Optional)
- 7) Span Gas Inlet: For feeding calibration gas to the analyzer. (Optional)
- 8) Vent: Exhaust from reaction chamber, ¼ inch tube fitting.
- 9) Output Connectors: Analog Outputs and Remote Functions.
- 10) TCP/IP Port to Network Connector.
- 11) Serial Port to Serial Connector
- 12) Filter: Analyzer Filter Housing

8.2. Main Connector (Standard 28 Pin Connector)

8.2.1. Main Connector (Standard 28 Pin Connector)

Pin	Signal	Function	Pin	Signal	Function
1	Analog Output	Ground (Analog)	15	Digital Input	Control Range 3
2	Analog Output	Real Time	16	Digital Input	Control Range 4
3	Analog Output	NO	17	Digital Input	Auto Cal
4	Analog Output	NO ₂	18	Digital Input	Calibrate
5	Analog Output	O ₂	19	Digital Input	Zero
6	Digital Output	Ground (Digital)	20	Digital Input	Span
7	Digital Output	Sense Auto Range	21	Digital Input	Pump
8	Digital Output	Sense Range 1	22	Digital Output	Zero Gas Flow
9	Digital Output	Sense Range 2	23	Digital Output	Span Gas Flow
10	Digital Output	Sense Range 3	24	Digital Output	Sample Gas Flow
11	Digital Output	Sense Range 4	25	Digital Output	Local/Remote
12	Digital Input	Set Auto Range	26	Digital Output	Read Cal Mode
13	Digital Input	Control Range 1	27	Digital Output	Reserved
14	Digital Input	Control Range 2	28	Digital Output	Reserved

8.2.2. Auxiliary Connector (Standard 28 Pin Connector)

Pin	Signal	Function	Pin	Signal	Function
1	Analog Input	Ground	15	Digital Output	Ground (Alarm)
2	Analog Input	External Analog 1	16	Digital Output	Calibrate Alarm 1
3	Analog Input	External Analog 2	17	Digital Output	Reserved
4	Analog Input	Spare Analog	18	Digital Output	Reserved
5	Analog Input	Spare Analog	19	Digital Output	Reserved
6	Digital Output	Ground (Alarm)	20	Digital Output	Read Wet Mode
7	Digital Output	General Alarm	21	Digital Output	Read Overflow
8	Digital Output	Ch 1 Conc Alarm	22	Digital Output	Read NO Mode
9	Digital Output	Ch 2 Conc Alarm	23	Digital Input	Set Wet Mode
10	Digital Output	Reserved	24	Digital Input	Set Overflow Mode
11	Digital Output	Reserved	25	Digital Input	Set NO Mode
12	Digital Input	Reserved	26	DI/DO	spare
13	Digital Input	Reserved	27	DI/DO	Spare
14	Digital Input	Reserved	28	DI/DO	Spare

8.2.3. Digital Outputs – RS-232 (Standard 9 Pin DIN Connector)

Pin	Function
1	DCD Carrier Detect
2	RxD Receive Data
3	TxD Transmit Data
4	DTR Data Terminal Ready
5	Ground
6	DSR Data Set Ready
7	RTS Ready to Send
8	CTS Clear to Send
9	RI Ring Indicator

8.2.4. Digital Outputs – TCP/IP (8 Pin RJ-47 Connector)

Pin	Function
1	TDX+
2	TDX-
3	RXD+
4	Open
5	Open
6	RXD-
7	LNLED
8	LNLED

IMPORTANT TIP: For direct connect to a PC a crossover cable is required. Connection to a hub requires a straight cable.

8.3. Internal Component Locations

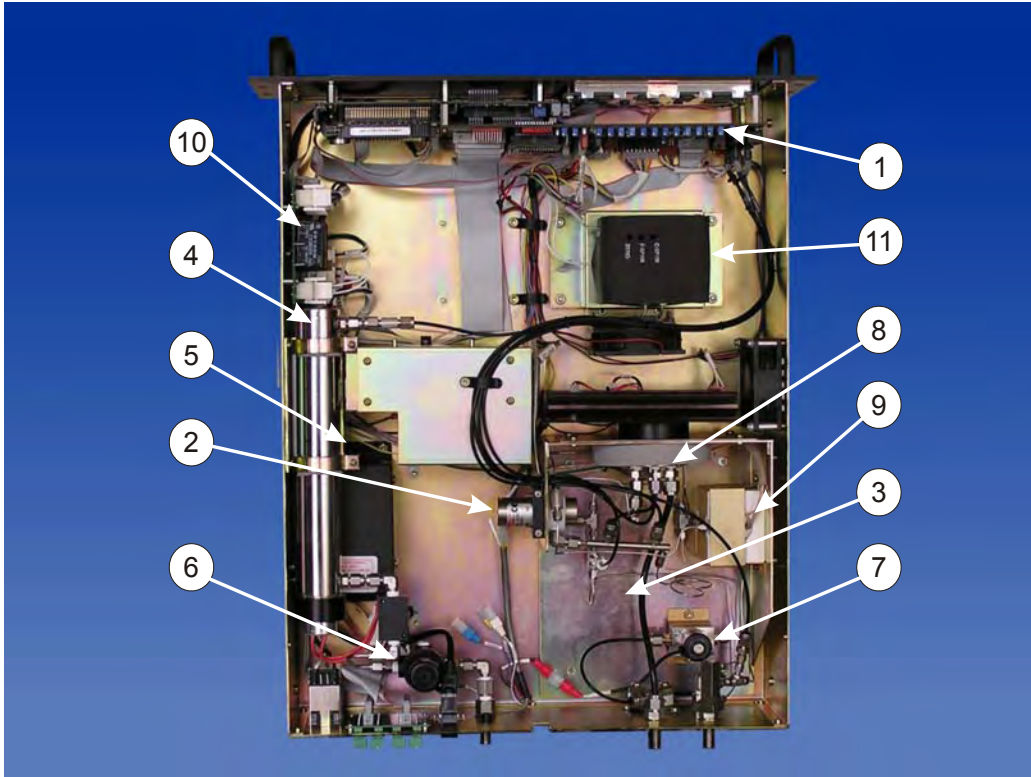
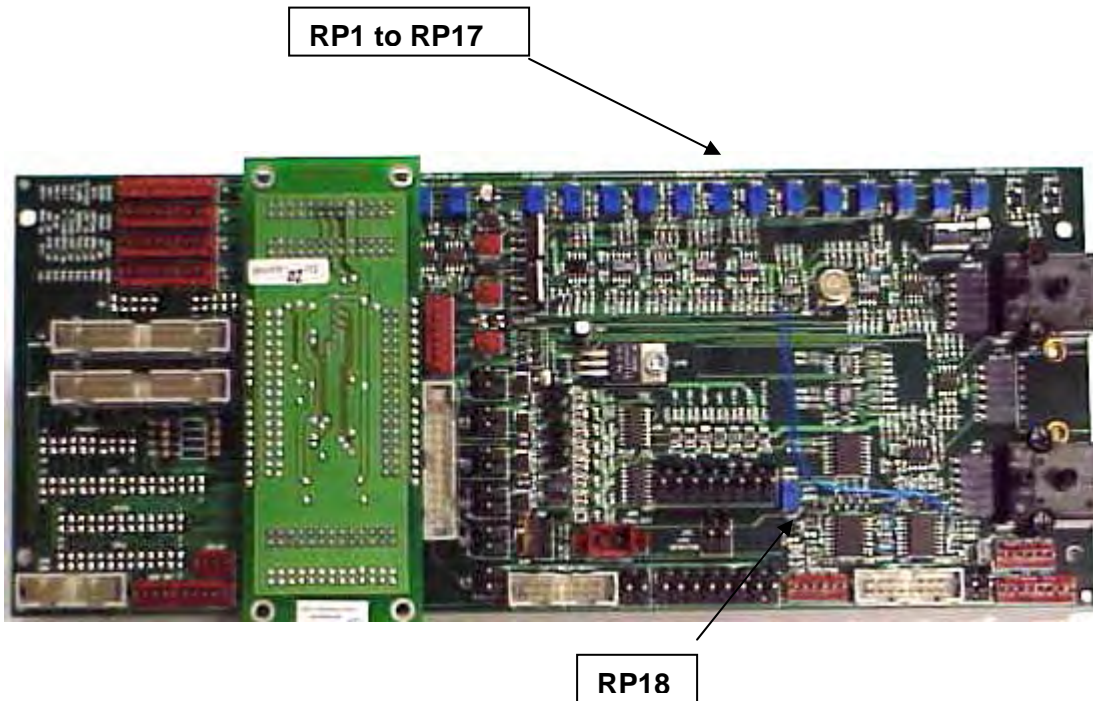

Figure 8-1 Major Internal Components

- 1) **Electronics:** Includes instrument electronics. (See Main Electronic Board)
- 2) **NO/NO_x Solenoid Valve:** Switches flow between the NO and NO_x mode.
- 3) **Optional Internal Sample Pump:** Provides sample to analyzer. (Not shown)
- 4) **Ozonator:** Contains UV Lamp.
- 5) **Ozonator High Voltage Supply:** Produces High Voltage to UV lamp.
- 6) **Proportional Flow Pressure Regulator:** Regulates flow of ozone.
- 7) **Proportional Flow Pressure Regulator:** Regulates flow of sample.
- 8) **Reaction Chamber & Detector Assembly:**
- 9) **NO/NO_x Converter:** Converts NO₂ to NO for total NO_x
- 10) **Relay Control Board:** Provides AC Voltage to Heaters, Pump and UV Transformer.
- 11) **Paramagnetic Oxygen Sensor:** Measures oxygen content of sample.

8.4. Main Electronics Board (Potentiometers)



8.5. Main Electronic Board Potentiometers

RP1 : EPC 9.5V Sample Set	RP10 : Chiller Zero Temp Set
RP2 : EPC 9.5V Air Set	RP11 : Chiller Span Temp Set
RP3 : O3 Cutoff	RP12 : Chiller Temp Set
RP4 : Cell Temp Set	RP13 : 12VDC Adjust
RP5 : Oven Temp Set	RP14 : Sample Pressure Set
RP6 : Pump Temp Set	RP15 : Air Pressure Set
RP7 : Converter Temp Set	RP16 : Not Used
RP8 : O2 Temp Set	RP17 : Not Used
RP9 : NH3 Temp Set	RP18 : PGA Balance

NOTE: Potentiometers are clearly labeled on both sides of the PCB.

8.6. Main Electronics Board (Connectors)

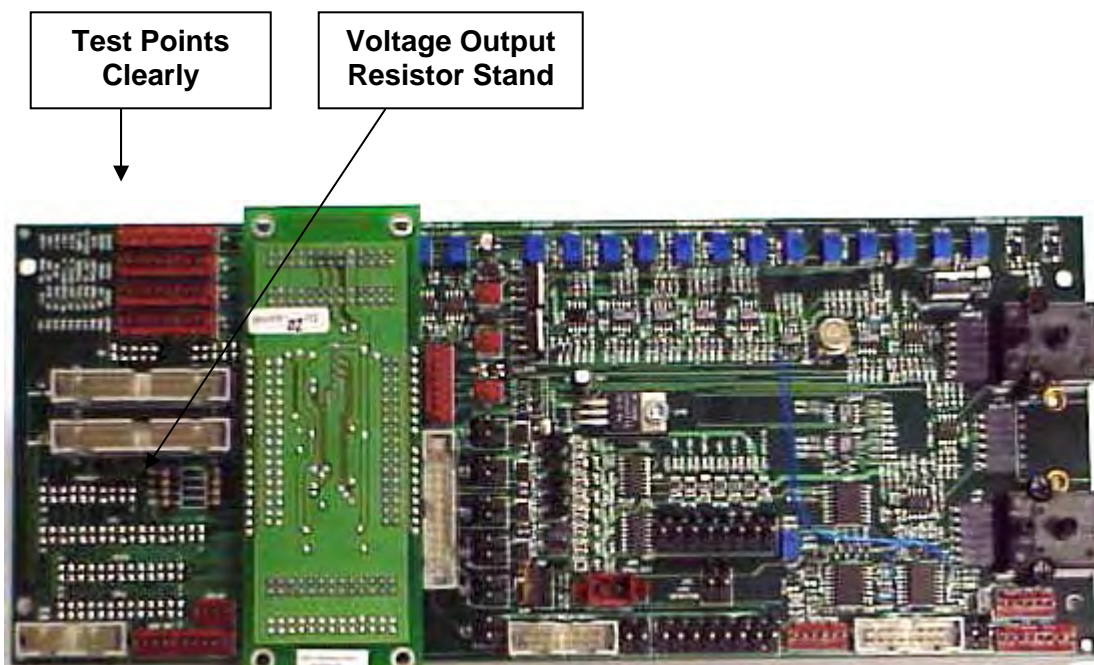

8.7. Main Electronic Board Connectors

J1	: Test Points	J2	: Test Points
J3	: Test Points	J4	: EPC Air Valve
J5	: Test Points	J6	: Digital Output 2 (DIDO Board)
J7	: EPC Sample	J8	: Sample Transducer
J9	: Aux Back Panel	J10	: Spare Digital Output
J11	: Diluter	J12	: Main Back Panel
J13	: Digital Input 2	J14	: NO/NO _x Valve
J15	: Diluter Transducer	J16	: Span Valve
J17	: Digital Output 1	J18	: Zero
J19	: Aux Power	J20	: Air Transducer
J21	: Sample Overflow Valve	J22	: Daisy Chain Input 1 (DIDO Board)
J23	: Wet/Dry Valve	J24	: Chiller Out
J25	: + 5 Volt Detector	J26	: Spare Analog Input
J27	: Chiller Temp Sense	J28	: Spare Back Panel
J29	: Spare Digital Input	J30	: Daisy Chain Output (DIDO Board)
J31	: Fan Power	J32	: Relay Board
J33	: Chiller Power	J34	: Power
J35	: Detector	J36	: O2 Detector
J37	: Thermocouple	J38	: RTD
JP1	: PGA Zero		

NOTE: Connections are clearly labeled on the PCB

8.8. Reaction Chamber

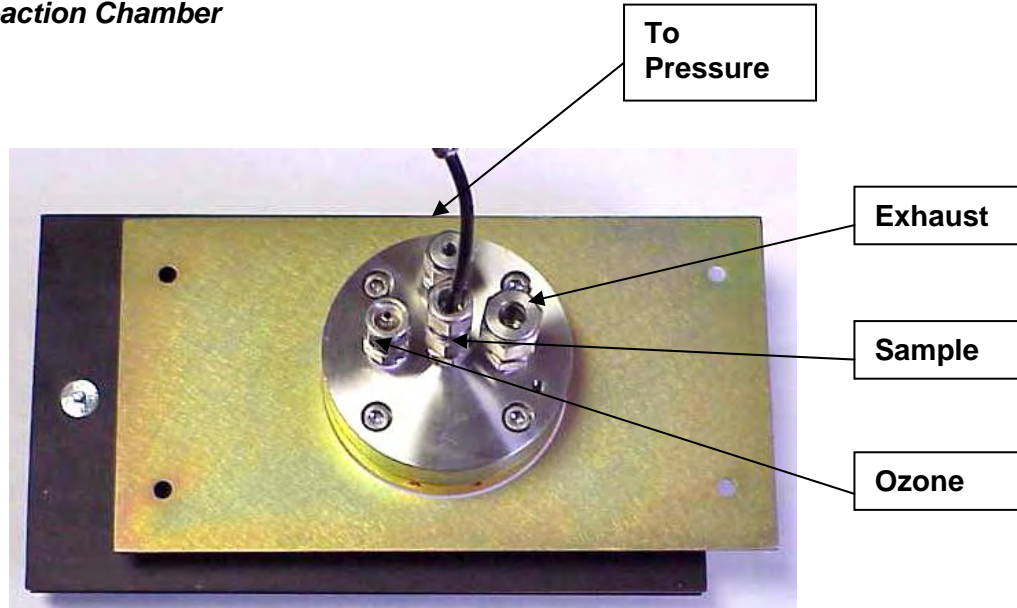

Reaction Chamber Assembly (Oven Side)

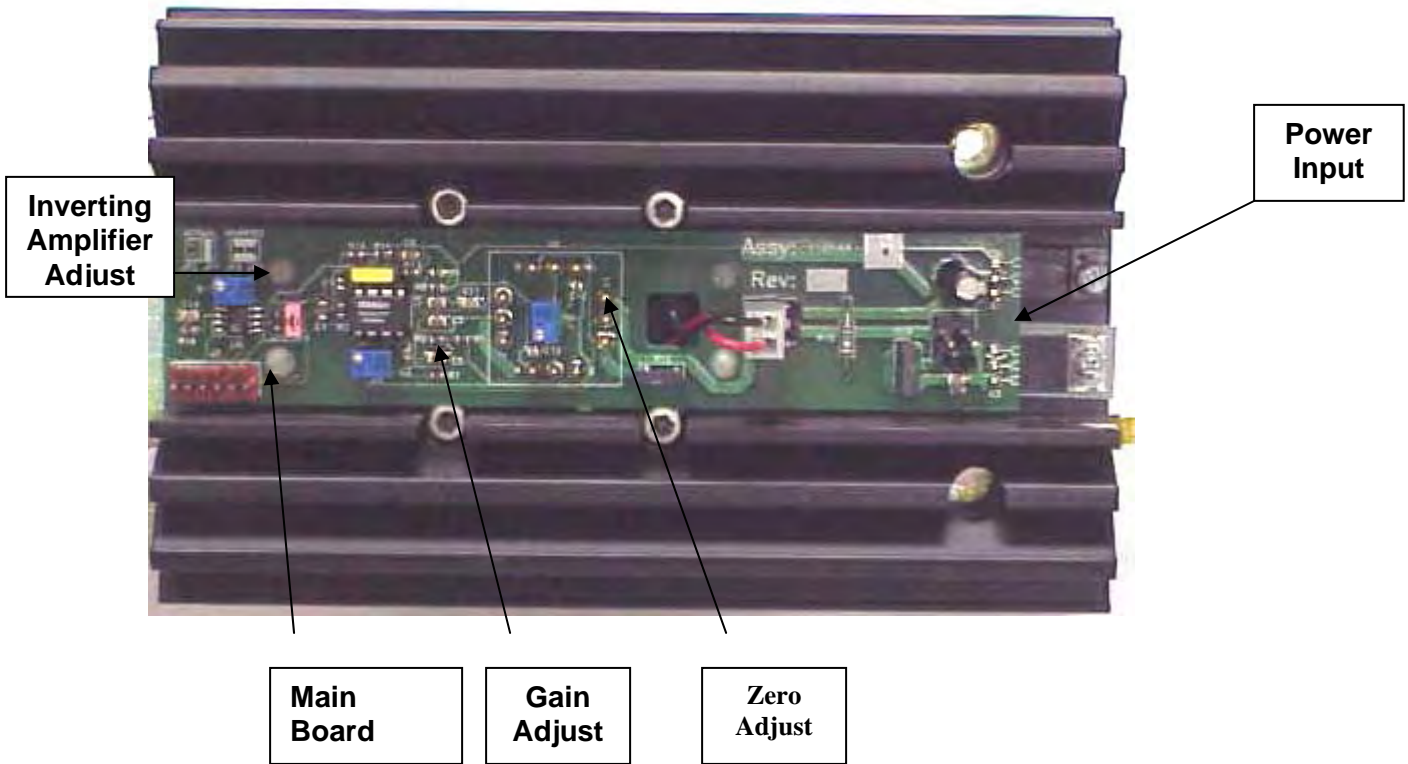

Figure 8-2 Reaction Chamber Pre-Amplifier

8.9. Relay Board Connections

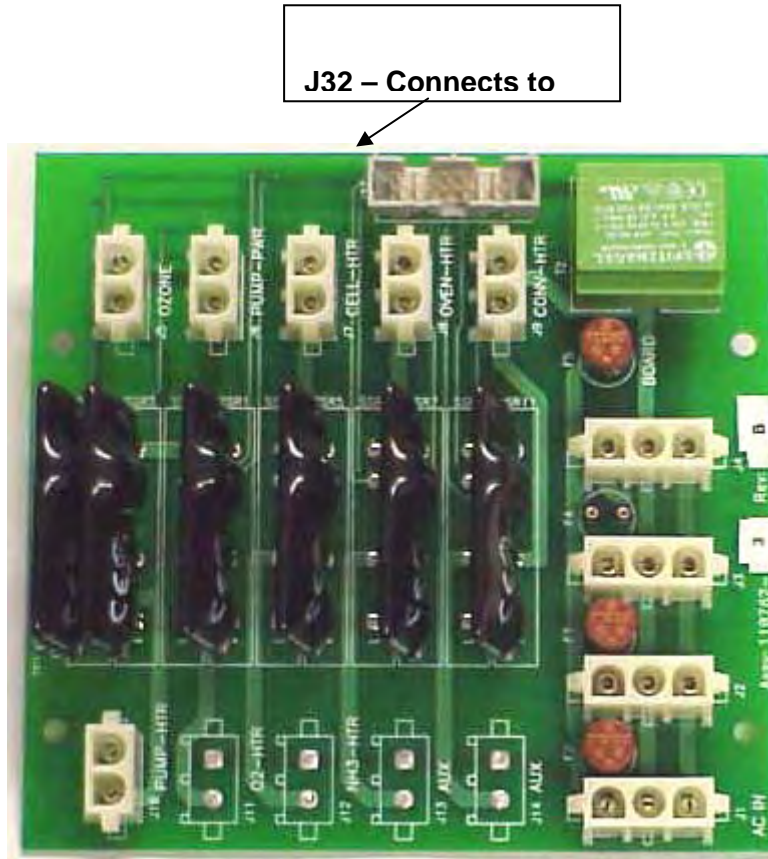

Figure 8-3 Relay Board Connections

J1	AC Input	J2	Power Supply 1
J3	Power Supply 2	J4	Power Supply 3
J5	Ozone Lamp	J6	Pump Power
J7	Cell Heater	J8	Oven Heater
J9	Converter Heater	J10	Pump Heater
J11	Optional O2 Heater	J12	Optional NH3 Heater
J13	Aux	J14	Aux

9. Operation

9.1. Preparation for Operation

Check that the external plumbing and wiring have been connected correctly, as described in this manual.

NOTE: *The internal ozone generator requires approximately 1 hour of continuous operation for the analyzer to achieve full zero and span calibration stability.*

9.2. Operation

- 12) Power On: Turn ON the power switch on the rear panel. The digital display should illuminate.
- 13) Introduce Ozone Supply (Air or O₂): Adjust the cylinder output pressure to 25 PSIG. The internal air pressure is factory set to deliver the air pressure required for optimum analyzer performance as indicated in the factory settings screen.
- 14) Air or O₂ Pressure Settings: Check the air pressure setting by referring to the diagnostic screen to check air pressure. The pressure should read as indicated in the factory settings screen.

Note: *Zero and span calibrations may also be initiated by an external computer or by remote contact closures.*

- 15) Zero Adjustment: Flow zero gas through the instrument by selecting the calibration screen and select either manual or auto calibrate. Perform a zero calibration for all ranges on both NO/NO_x and O₂ channels.
8. Span Adjustment: Flow span gas through the instrument by selecting the calibration screen and select either manual or auto calibrate. Perform a span calibration for all ranges on both NO/NO_x and O₂ channels.

NOTE: *The correct calibration gas values must be entered. The instrument is available from the factory with four ranges.*

- 16) NO/NO_x Function: The analyzer switches the NO_x converter in and out of the sample stream and is controlled from the measurement screen. In the NO mode, the sample bypasses the converter and the resultant analysis produces the value of NO (Only) in the sample. In the NO_x mode, the sample passes through converter and the resultant analysis produces the value of NO_x (NO + NO₂) in the sample. The analyzer will also display the values of NO_x, NO and NO₂. The NO mode may be switched in and out remotely by a contact closure or computer. Remote control wiring is terminated in the rear panel connector. (See Appendix).
- 17) Sample Pressure Check: With sample gas flowing through the instrument, check the sample pressure setting by referring to the diagnostic screen. The sample pressure should read as indicated in the factory pressure settings screen.
- 18) Sample Pump: If the analyzer is supplied with the optional internal sample pump, it is always on in the measure mode. It is turned off during calibration and may be manually turned off by putting the analyzer in standby.
- 19) Sample Line: Make certain the sample line is flushed before connecting to the analyzer sample inlet.

- 20) Instrument Power: Turn instrument power on and allow the reaction chamber and NO_x converter to stabilize before turning on the sample pump and/or connecting the sample line.
- 21) Sampling System: Prepare and check the sample system. Check the sample pressure as indicated in the factory settings screen.
- 22) Air or O₂ Pressure: Check the Air/O₂ pressure for proper setting as indicated in the factory setting screen. Readjust internal pressure as required. Note: Cylinder pressure should be set at 25 PSIG.
- 23) Zero & Span Calibration: Zero and span adjustment should be checked every 24 hours by either manual or automatic calibrations.
- 24) Reaction Chamber Assembly: Dust, water droplets, or mist entering the reaction chamber assembly may cause drift due to contamination. If the calibration procedure fails to bring the instrument to zero, check the chamber for contamination.

9.3. Shut Down Procedure

- 1) Turn off the zero, span and air/O₂ cylinders.
- 2) If the analyzer contains the optional internal sample pump, disconnect the sample line from the rear inlet port. Do NOT turn off the sample pump or analyzer power at this point.
- 3) Allow the analyzer to draw in room air for approximately 5 minutes, or flush out any remaining sample which may cause condensation as the analyzer cools.
- 4) Turn off the optional internal sample pump by setting the analyzer to standby.
- 5) Turn off the analyzer power.
- 6) Back-flush the sample line (and filter) of any sample before disconnecting and powering down.

10. Functional Description

10.1. Operating Principle- NO/NO_x

The California Analytical Model 650 Analyzer utilizes the chemiluminescent method of determination of oxides of nitrogen (NO or NO_x) in a sample gas. In the NO mode, the NO in the sample is quantitatively converted to NO₂ by gas phase oxidation with molecular ozone produced by the UV reaction of cylinder air. Generally, 10 to 15 percent of these NO₂ molecules are elevated to an electronically-excited state. This reaction is immediately followed by reversion to a non-excited state and emission of photons. The photons impinge on a photodiode detector (PHOTODIODE) which generates a low DC current directly proportional to the NO contained in the sample gas. This current is amplified by a precision electrometer and presented to digital panel meter and recorder output. In the NO_x mode, the sample is first routed to the NO_x converter where the NO₂ component is reduced to NO. The complete sample is analyzed by the PHOTODIODE as above.

10.1.1. Reaction Chamber

The sample and ozone are delivered to the reaction chamber via the unique regulated flow system described below. The sample and ozone are mixed together at the center of the chamber where the reaction takes place. The sample is vented from the chamber through a 1/8 inch stainless steel tube. The chamber contains a red filter which is sealed with an integral O Ring. The chamber assembly is O Ring mounted to the PHOTODIODE. The complete chamber and PHOTODIODE assembly is housed in an RFI shielded enclosure.

10.1.2. Flow System

The basic function is to deliver highly regulated flows of sample and air or O₂ to the ozonator and reaction chamber assemblies. The EPC valve delivers approximately 15 PSIG to a pre-set capillary and consequently accurately predetermines the ozone flow rate. The air supply cylinder should be set to 25 psig. The sample is presented to the reaction chamber via a precision, factory set electronically controlled proportional pressure valve through a capillary. This pressure is factory set at approximately 3.85 PSIG. A close coupled bypass capillary minimizes "dead volume" and improves response time. Sample inlet pressure and regulated air pressures are monitored by internal pressure transducers and presented in PSIG via the diagnostics screen. NOTE: The correct pressures are determined by the factory for optimum analyzer performance and measured by N.I.S.T. traceable standards. They are recorded on the Factory Settings Screen.

10.1.3. Main Electronics Board

The main electronics board contains the instrument power supplies and required instrument electronics. A single transformer provides power to the main circuit board and includes provisions for 110/220 VAC at 50/60 Hz input.

10.1.4. Relay Board

The relay circuit board contains the logic circuitry required to control and switch the AC power to the required heaters and sample pump.

10.2. Principle of Operation-Oxygen

The paramagnetic susceptibility of oxygen is significantly greater than that of other common gases, and consequently, the molecules of oxygen are attracted much more strongly by a magnetic field than the molecules of the other gases. Most of the other gases are slightly diamagnetic, which means that their molecules are then repelled by a magnetic field.

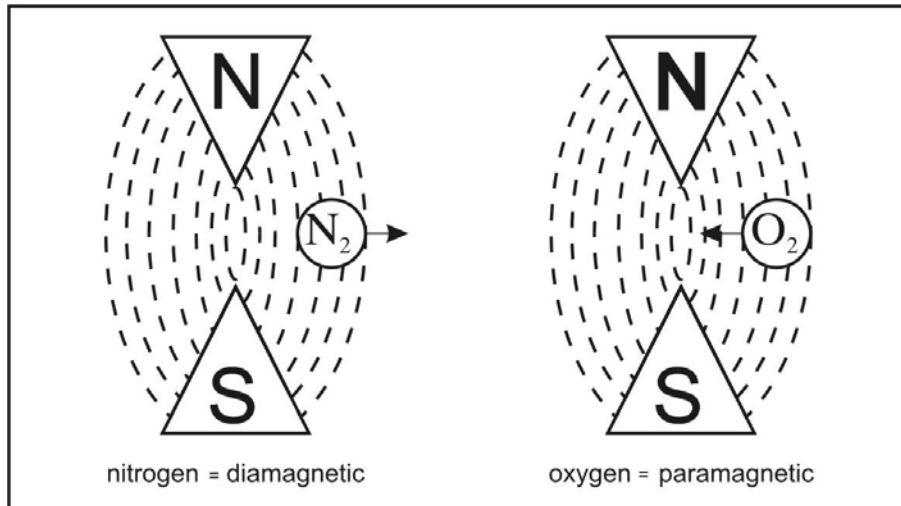

Figure 10-1 Magnetic Susceptibility of gases

The principle of the magneto dynamic cell is based upon Faraday's method of determining the magnetic susceptibility of a gas. The cell consists of two nitrogen-filled quartz spheres arranged in the form of a dumbbell. A single turn of platinum wire is placed around the dumbbell that is suspended in a symmetrical non-uniform magnetic field.

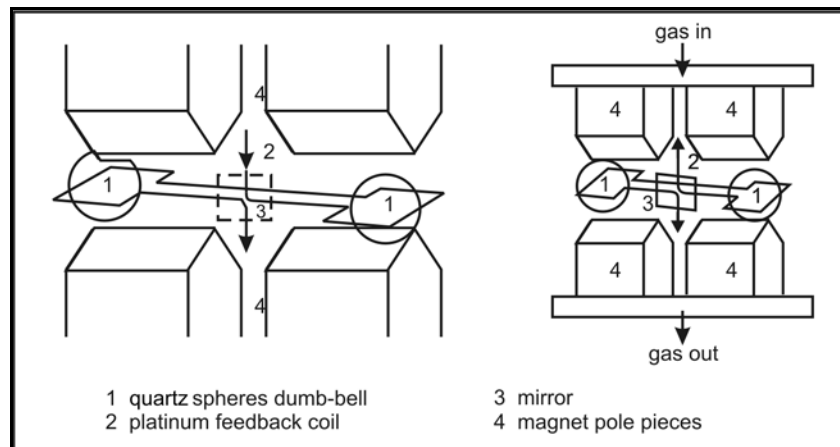

Figure 10-2 The Measuring cell in theory

When the surrounding gas contains oxygen, the dumbbell spheres are pushed out of the magnetic field by the change in the field that is caused by the relatively strong paramagnetic oxygen. The torque acting on the dumbbell is proportional to the paramagnetic properties of the surrounding gas and, therefore, it can be used as a measure of the oxygen concentration.

The distortion of the dumbbell is sensed by a light beam and projected on a mirror attached to the dumbbell whereof it is reflected to a pair of photocells. When both photocells are illuminated equally, the output will be zero. The output from the photocells is connected to an

amplifier, which in turn is fed to the feedback coil of the measuring cell. If the oxygen content of the gas sample changes, the corresponding current output of the amplifier, which is proportional to the oxygen content, produces a magnetic field in the feedback coil opposing the forces and thereby causing the dumbbell to rotate.

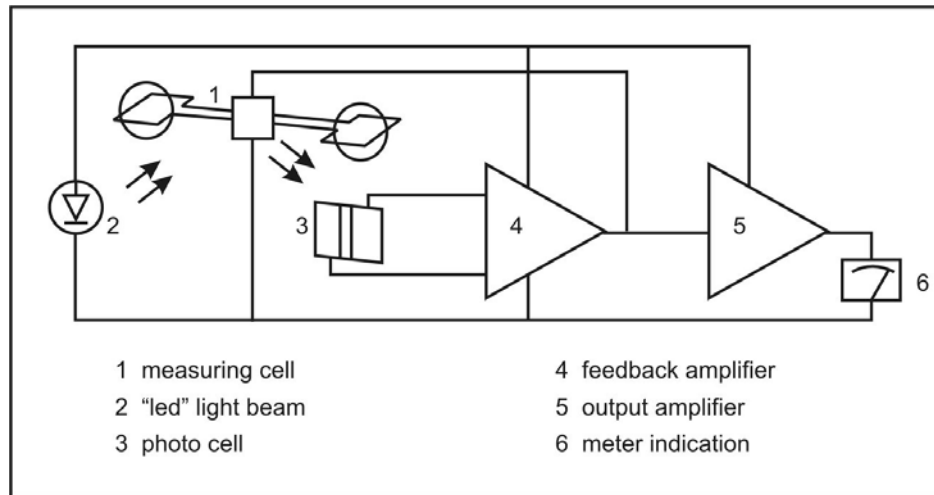

Figure 10-3 Principle of operation

Since the feedback current from the amplifier is proportional to the oxygen content of the gas sample, the output signals that are produced by the amplifier will be accurate and linear. The paramagnetic susceptibility of oxygen varies inversely as the square of the absolute temperature. To provide compensation for changes in analyzer temperature, a temperature sensitive element in contact with the measuring cell assembly is included in the feedback current circuit.

10.3. Cross sensitivity of gases

The very high magnetic susceptibility of oxygen is the basis of the paramagnetic measuring principle. In comparison to oxygen, other gases have such a minor susceptibility that most of them are insignificant. Exceptions to this are the nitrogen oxides. However, as these gases are in most cases present in a very low concentration, the error is still negligible.

Example 1

The residual oxygen percentage is measured in a closed carbon dioxide (CO₂) atmosphere. Nitrogen (N₂) is used for "zero calibration."

According to the list of cross-sensitivities, the error for 100 % CO₂ at 20° C is 0.27%. In order to obtain a higher accuracy, this means that for the zero calibration the reading should be adjusted at +0.27% with N₂, in order to compensate the error of CO₂.

Since the values of cross-sensitivities are based on 100% volume of that particular gas, the error at 50% by volume CO₂ and 50% by volume N₂ is 0.135%.

Example 2

Given the following gas composition at a temperature of 20° C:

5% volume Oxygen (O₂)	+100.00 x 10⁻² x 5 =	+5.0000
40% volume Carbon Dioxide(CO₂)	-0.27 x 10⁻² x 40 =	-0.1080
1% volume Ethane(C₂H₆)	-0.43 x 10⁻² x 1 =	-0.0043
54% volume Nitrogen (N₂)	0.00 X 10⁻² x 54 =	0.0000
Gives a reading (% by volume) of:		+4.8877

As this example shows, the total error (5.000 minus 4.8877) is 0.1123.

Note: see Table 10-1 below for cross sensitivity values of typical gases.

Table 10-1 Cross Sensitivity of gases

All values based on nitrogen 0% / oxygen 100%

Gas	Formula	20 °C	50 °C
Argon	Ar	-0.23	-0.25
Acetylene	C ₂ H ₂	-0.26	-0.28
Acetone	C ₃ H ₆ O	-0.63	-0.69
Acetaidehyde	C ₂ H ₄ O	-0.31	-0.34
Ammonia	N ₃	-0.17	-0.19
Benzene	C ₆ H ₄	-1.24	-1.34
Bromine	Br ₂	-1.78	-1.97
Butadiene	C ₄ H ₆	-0.85	-0.93
Isobutylene	(CH ₃) ₂ CH=CH ₂	-0.94	-1.06
n-Butane	C ₄ H ₁₀	-1.10	-1.22
Chlorine	CL ₂	-0.83	-0.91
Hydrogen Chloride	HCL	-0.31	-0.34
Nitrous Oxide	N ₂ O	-0.20	-0.22
Diacetylene	(CHCl) ₂	-1.09-	-1.20
Ethane	C ₂ H ₄	-0.43	-0.47
Ethylene Oxide	C ₂ H ₄ O ₂	-0.54	-0.60
Ethylene	C ₂ H ₄	-0.20	-0.22
Ethylene Glycol	CH ₂ OHCH ₂ OH	-0.78	-0.88
Ethylbenzene	C ₈ H ₁₀	-1.89	-2.08
Hydrogen Fluoride	HF	+0.12	+0.14
Furan	C ₄ H ₄ O	-0.90	-0.99
Helium	He	+0.29	+0.32
n-Hexane	C ₆ H ₁₄	-1.78	-1.97
Krypton	Kr	-0.49	-0.54
Carbon Monoxide	CO	-0.06	-0.07
Carbon Dioxide	CO ₂	-0.27	-0.29
Methane	CH ₄	-0.16	-0.17
Methanol	CH ₄ O	-0.27	-0.31
Methylene Chloride	CH ₂ Cl ₂	-1.00	-1.10
Neon	Ne	+0.16	+0.17
n-Octane	C ₈ H ₁₈	-2.45	-2.70
Phenol	C ₆ H ₆ O	-1.40	-1.54
Propane	C ₃ H ₈	-0.77	-0.85
Propylene	C ₃ H ₆	-0.57	-0.62
Propene	CH ₃ CH=CH ₁₂	-0.58	-0.64
Propylene Oxide	C ₃ H ₆ O	-0.90	-1.00
Propylene Chloride	C ₃ H ₇ Cl	-1.42	-1.44
Silane	SiH ₄	-0.24	-0.27
Styrene	C ₇ H ₆ =CH ₂	-1.63	-1.80
Nitrogen	N ₂	-0.00	-0.00
Nitrogen Monoxide	NO	+42.70	+43.00
Nitrogen Dioxide	NO ₂	+5.00	+16.00
Oxygen	O ₂	+100.00	+100.00
Sulfur Dioxide	SO ₂	-0.18	-0.20
Sulfur Fluoride	SF ₆	-0.98	-1.05
Hydrogen Sulfide	H ₂ S	-0.41	-0.43
Toluene	C ₇ H ₈	-1.57	-1.73
Trichloroethylene	C ₂ HCl ₃	-1.56	-1.72
Vinyl Chloride	C ₂ H ₃ Cl	-0.68	-0.74
Vinyl Fluoride	CH ₃ F	-0.49	-0.54
Water	H ₂ O	-0.03	-0.03
Hydrogen	H ₂	+0.23	+0.26
Xenon	Xe	-0.95	-1.02

11. Reaction Chamber Servicing

11.1. *Disassembly Procedure*

- 1) Shut off ALL gas flow.
- 2) Remove power from the instrument.
- 3) Remove the top cover retaining screws.
- 4) Remove all 4 tubes from the 4 way cross.
- 5) Remove the 4 screws securing the photodiode and reaction chamber from the oven.
- 6) Remove the photodiode electrical connector from the main circuit board.
- 7) Remove the chiller connection from the photodiode/reaction chamber.
- 8) Separate the photodiode and heat sink assembly from the reaction chamber by removing the 4 Allen screws from the front of the heat sink. Save the 2 black rubber "O" rings.
- 9) Separate the mounting plate and the glass filter from the reaction chamber. Save the 2 Teflon spacers and "O" ring.
- 10) Separate the manifold from the gold reaction chamber. NOTE the position of the holes in the Teflon gasket relative to the assembly screw holes. The large hole is ozone.

11.2. *Assembly Procedure*

- 1) Wash the reaction chamber glass filter and manifold separately in detergent using a test tube brush. Be careful of the sample tube in the manifold. Do not use abrasives.
- 2) Dry by blowing clean with dry nitrogen.
- 3) Reassemble the chamber assembly in reverse order per the above. Make certain the sample tube is centered when assembling the manifold to the reaction chamber.

12. Troubleshooting

12.1. Ozone Air/O₂ Supply

The Air/O₂ flow is controlled by an EPC valve. It requires 25 psig cylinder supply pressure and is factory set to deliver approximately 10 to 20 psig to the ozone capillary. This pressure may be monitored by the diagnostics display. The flow rate from the capillary is very low and will require a bubble flow meter to accurately determine proper flow.

12.2. Sample Supply

The sample flow is controlled by an adjustable electronic proportional pressure valve. This valve requires a 10 to 25 PSIG sample supply pressure to deliver the proper pressure to the sample capillary. This pressure may be monitored by the diagnostics meter at any time after inlet sample has been applied. The sample flow rate from the capillary is very low and will require a bubble flow meter to determine proper flow rate. If the pressure is properly set, and a clogged capillary is suspected, replace the sample capillary.

NOTE: *If the analyzer contains an optional internal sample pump, the introduction of a pressurized sample gas in excess of 1.5 PSIG will damage the pump.*

12.3. NO/NO_x Converter

Several published test procedures require periodic NO_x efficiency tests to be performed on the converter to determine NO₂ to NO conversion efficiency utilizing a NO_x generator. The CAI Model NOxGen may be used for this procedure. A short test using NO₂ calibration gas is also defined in the U.S Federal Register, Title 40, Part 86.332.79 (e).

13. AK Protocol Format

The master computer and the Model 650 analyzer communicates via the RS232 serial link. The Model 650 analyzer acts as a "slave" and only responds to commands.

Serial Interface Parameters:

- 1) Baud from 300 to 9600 bps, can be selected via the display.
- 2) 7 or 8 data bits, 1 or 2 stop bits, and the parity (yes/no).
- 3) The data transmission is full duplex (no echo) with XON/XOFF protocol.
- 4) The "don't-care" byte" (byte 2) is adjustable (factory setting 20H).

Command Format:	
<STX>	02H Example: ASTZ K0
don't care	any byte (default 20H)
function code	code 4 byte long (e.g., ASTZ)
space 20H	20H
channel N° always "K0" for the analyzer	
space	20H (only if followed by data, otherwise <ETX>)
data	data bytes (depending on the command)
<ETX>	03H
Answer Format:	
<STX>	02H Example: STZ 0 SREM STBY
don't care	adjustable, factory setting 20H
function code	same code as command package (e.g., ASTZ)
space	20H
status	0 without error or 1 to 9 when error (see also ASTF command)
space	20H (only if followed by data, otherwise <ETX>)
data	parameter (depending on the command)
<ETX>	03H

13.1. Serial Interface and AK-Commands

The serial interface enables remote control of the Model 650 analyzer by a master computer. It is implemented as an RS232 V24 interface and meets all requirements of the AK protocol.

A 9-pin male connector at the back of the unit is used to connect a master computer with the following pin assignment:

Pin 3 = Txd (transmit)

Pin 2 = Rxd (receive)

Pin 5 = Gnd (ground)

13.2. Interface Parameters

Baud rate:	9600, 4800, 2400, 1200, 600, 300 baud
Data bits:	7 or 8
Stop bit:	1 or 2
Don't care:	1 byte, adjustable (e.g. 32)
Parity:	Even, odd, none
XON/XOFF:	Active or not active

13.3. General AK Requirements

- 1) If the command message contains no error, the acknowledge message contains the echo of the function code and the error status number (1 to 9).
- 2) If the transfer was faulty or the function code unknown, the answer contains four question marks (example. "???? 0").
- 3) If the displayed value is not valid, a "#" is placed in front of the measured value (example: "AIKG 0 #9999").
- 4) If a control or adjusting command is sent via the serial interface while the measuring device is in "Manual" mode, it sends an answer like "SLIN 0 K0 OF".
- 5) If a channel does not exist, the answer for control and adjusting commands is e.g. "ATEM 0 3 NA" in which 3 is the number of the sub-channel.
- 6) If the device is busy with a running function (SLIN, for example), every arriving control command is ignored (except SRES and STBY); and the response message is e.g. "SMAN 0 BS. If in the mode "SINT" an additional "SINT KO" command is received, the integrator is reset to 0 and the integration is restarted.
- 7) If the command message contains data that the measuring device cannot process ("ESYZ K0 ABC", for example,) the response message is "ESYZ 0 SE". A syntax error is recognized if the data does not match the expected format or if the parameters do not fit the expected size.
- 8) Numbers are in floating-point format with decimal point. The decimal point can be dropped for integers.
- 9) If you switch from "Manual" to "Remote" at the device, it remains in "Manual" mode until a "SREM K0" is received by the control computer. On the display, this mode is indicated by REME" (Remote enable) on the status line. In manual mode, query commands via the serial interface are possible at any time.

13.4. Scans

AKON: Measured concentration value

Command	Response	Description
_AKON_K0	_AKON_s_z.z_y.y_x.x_w.w	Measured concentration value is responded z.z: Current measured value y.y: NO x.x: NO2 w.w: NOx y.y,x.x,w.w are only used in dual measure mode. Otherwise "O.O" will be returned

AEMB: Set measuring range

Command	Response	Description
_AEMB_K0	_AEMB_s_Mn	Current measuring range is responded

AMBE: Measuring range limit

Command	Response	Description
_AMBE_K0	_AMBE_s_M1_w.w_M2_x.x_M3_y.y_M4_z.z	All existing measuring range limits are responded
_AMBE_K0_Mn	_AMBE_s_Mn_z.z	Range limit of Range Mn is responded

AKAK: Calibration gas concentrations

Command	Response	Description
AKAK_K0	_AKAK_s_M1_w.w_M2_x.x_M3_y.y_M4_z.z	All existing calibration gas values are responded
AKAK_K0_Mn	AKAK_s_Mn_z.z	Calibration gas value of Range Mn is responded

AMBU: Upper and lower range switchover values for auto range

Command	Response	Description
_AMBU_K0	_AMBU_s_M1_w.w_W.W_M2_x.x_X.X_M3_y.y_Y.Y_M4_z.z_Z.Z	Lower and upper range switchover value of auto range are responded

ASTZ: Normal device status

Command	Response	Description
_ASTZ_K0	_ASTZ_s_SREM_STBY__SENO_SARE_SDRY	Device status is responded

Possible states:

SREM: remote	STBY: standby	SENO: NO mode	SARE: Autorange on	SDRY: Chiller on
SMAN: manual	SPAU: pause	SMAN: NO _x mode	SARA: Autorange off	SWET: Chiller off
	SMGA: measuring gas			
	SNGA: zero gas			
	SEGA: end gas			
	SATK SNGA: zero gas during autocal			
	SATK SEGA: end gas during autocal			
	SLIN: For compatibility only			
	SSPL: purging			
	SKOP: measure			

ASTF: Error status

Command	Response	Description
_ASTF_K0	_ASTF_s_f1_f2_f3..._f15	Current error number is responded

Errors:

1	Sample Pressure Failure	10	EPC Coil Sample Failure
2	Air Pressure Failure	11	EPC Coil Air Failure
3	Oven Temp Failure	12	Range Overflow
4	Converter Temp Failure	13	ADC Range Overflow
5	Pump Temp Failure	14	ADC Range Underflow
6	Diode Temp Failure	15	Range 1 is not calibrated
7	Cell Temp Failure	16	Range 2 is not calibrated
8	Peltier Gas Temp Failure	17	Range 3 is not calibrated
9	Reaction Chamber Temp Failure	18	Range 4 is not calibrated

AKEN: Device identification

Command	Response	Description
_AKEN_K0	_AKEN_s_devicename	Device identification is responded
_AKEN_K1	_AKEN_s_model	Device model
_AKEN_K2	_AKEN_s_serialno	Device serial number
_AKEN_K3	_AKEN_s_airpressure	Suggested input air pressure
_AKEN_K4	_AKEN_s_samplepressure	Suggested input sample pressure

ARMU: Raw value

Command	Response	Description
_ARMU_K0	_ARMU_s_z.z	Raw value before linearization and offset-span-correction is responded

ATEM: Temperatures

Command	Response	Description
_ATEM_K0	_ATEM_s_z.z_y.y...	All Temperatures in degrees Celsius are responded
_ATEM_K0_x	_ATEM_s_z.z	Temperature of x in degrees Celsius is responded

Description of x:

X	CLD
1	Oven Temp
2	Converter Temp
3	Pump Temp
4	Diode Temp
5	Cell Temp
6	Peltier Temp
7	Reaction Chamber Temp

ADRU: Pressures

Command	Response	Description
_ADRU_K0	_ADRU_s_z.z_y.y_...	All pressures are responded
_ADRU_K0_x	_ADRU_s_z.z	Pressure of x is responded

Description of x:

1	Sample Pressure
2	Air Pressure
3	Sample EPC Coil Voltage
4	Air/Ozone EPC Coil Voltage

ADUF: Flows

Command	Response	Description
_ADUF_K0	_ADRU_s_z.z_y.y_...	All flows are responded
_ADUF_K0_x	_ADRU_s_z.z	Flow of x is responded

Description of x:

1	Sample Flow
2	Air Flow

AGRD: Polynom coefficients

Command	Response	Description
_AGRD_K0_Mn	_AGRD_s_Mn_a0_a1_a2_a3_a4	Polynom coefficients of range Mn are responded

AANG: Deviation from zero point after autocalibration

Command	Response	Description
_AANG_K0	_AANG_s_M1_z.z_da_dr_ M2_z.z_da_dr_ M3_z.z_da_dr_ M4_z.z_da_dr_	Deviation from zero point after autocalibration

AAEG: Deviation from end point after autocalibration

Command	Response	Description
_AAEG_K0	_AANG_s_M1_z.z_da_dr_ M2_z.z_da_dr_M3_z.z_da_dr_ M4_z.z_da_dr_	Deviation from end point after autocalibration

AFDA: Purge and Autocalibration times

Command	Response	Description
_AFDA_K0_SATK	_AFDA_s_z_y_x_w_Z.Z	Autocalibration times: z: Purge time y: Calibration time x: Total Calibration time w: Verify time (z,y,x,w in seconds)
_AFDAKO_SSPL	AFDA_s_z.z	Purge time will be responded

APAR: Request Autocalibration tolerance values

Command	Response	Description
_APAR_K0_SATK	_APAR_s_z.z_y.y_x.x_w.w	Autocalibration tolerance value (%): z.z: Range 1 y.y: Range 2 x.x: Range 3 w.w: Range 4

AKAL: Deviations from calibration

Command	Response	Description
_AKAL_K0_	_AKAL_s_M1_z.z_y.y_x.x_w.w _AKAL_s_M2_z.z_y.y_x.x_w.w _AKAL_s_M3_z.z_y.y_x.x_w.w _AKAL_s_M4_z.z_y.y_x.x_w.w	Deviation (ppm): z.z: Zero gas relative to last calibration y.y: Zero gas factory calibration x.x: Span gas relative to last calibration w.w: Span gas factory calibration

ASYZ: Respond System Time

Command	Response	Description
_ASYZ_K0_	_ASYZ_s_yymmdd_hhmmss	Respond system time yymmdd:year, month, day (each 2 characters wide, no spaces) hhmmss:hour, minutes, seconds)

AT90: Respond Lowpass filter time

Command	Response	Description
_AT90_K0_	_AT90_s_t	Respond lowpass filter time t=filter time in seconds

ADAL: Diagnostic alarm limits

Command	Response	Description
_ADAL_K0	_ADAL_s_a1.min_a1.max_.._f12.max	All alarms are responded
_ADAL_K0_x	_ADAL_s_x.min_x.max	Alarm limits of x

Alarm Limits:

1	Sample Pressure	7	Cell Temp
2	Air Pressure	8	Peltier Gas Temp
3	Oven Temp	9	EPC Coil Sample Voltage
4	Converter Temp	10	EPC Coil Air/Ozone Voltage
5	Pump Temp	11	Reserved
6	Diode Temp	12	Sample Content

ATCP: Query TCP/IP settings

Command	Response	Description
_ATCP_K0	_ATCP_s_zzz.zzz.zzz.zzz	zzz: TCP/IP Address
	_ATCP_s_yyy.yyy.yyy.yyy	yyy: TCP/IP subnet mask
	_ATCP_s_xxxx	xxxx: TCP/IP port

AENT: Query calibration gas flow setting

Command	Response	Description
_AENT_K0	_AENT_s_x	x=10: Calibration through sample gas inlet (pump) y=11: Calibration through zero/span valves

13.5. Control commands**SRES:** Reset

Command	Response	Description
_SRES_K0	_SRES_s	Reset

SPAU: Pause

Command	Response	Description
_SPAU_K0	_SPAU_s	Pause mode

STBY: Standby

Command	Response	Description
_STBY_K0	_STBY_s	Standby mode

SNGA: Open valve for zero gas calibration

Command	Response	Description
_SNGA_K0	_SNGA_s	Open valve for zero gas calibration of actual measuring range
_SNGA_K0_Mn	_SNGA_s	Open valve for zero gas calibration of range Mn

SEGA: Open valve for end gas calibration

Command	Response	Description
_SEGA_K0	_SEGA_s	Open valve for end gas calibration of actual measuring range
_SEGA_K0_Mn	_SEGA_s	Open valve for end gas calibration of range Mn

SSPL: Purge Analyzer with zero gas

Command	Response	Description
_SSPL_K0	_SSPL_s	Open valve for zero gas and purge the analyzer

SLIN: Linearization mode

Command	Response	Description
_SLIN_K0	_SLIN_s	Change status to SLIN (only for compatibility)

SKOP: Converter Check

Command	Response	Description
_SKOP_K0	_SKOP_s	Change status to SKOP and activate sample pump (only for compatibility)

SWET: Chiller off – Wet mode measuring

Command	Response	Description
_SWET_K0	_SWET_s	Switch chiller off

SDRY: Chiller on – Dry mode measuring

Command	Response	Description
_SDRY_K0	_SDRY_s	Switch chiller on

SATK: Start automatic calibration

Command	Response	Description
_SATK_K0	_SATK_	Start automatic calibration of all ranges
_SATK_K0_Mn	_SATK_s	Start automatic calibration using range Mn

SEMB: Set measuring range

Command	Response	Description
_SEMB_K0_Mn	_SEMB_s	Set measuring range Autorange is disabled

SARE: Auto range on

Command	Response	Description
_SARE_K0	SARE_s	Set auto range on

SARA: Auto range off

Command	Response	Description
_SARA_K0	_SARA_s	Set autorange off

SREM: Remote mode for AK-commands

Command	Response	Description
_SREM_K0	_SREM_s	Set device in remote mode

SMAN: Manual control to control device manually

Command	Response	Description
_SMAN_K0	_SMAN_s	Set device in manual mode

SMGA: Start measuring

Command	Response	Description
_SMGA_K0	_SMGA_s	Start measuring Turn on pump for sample gas

SNKA: Saves measured value as new offset.

Command	Response	Description
_SNKA_K0	_SNKA_s	Saves measured value of actual range as new offset if zero valve is opened

SEKA: Saves measured value as new span value

Command	Response	Description
_SEKA_K0	_SEKA_s	Saves measured value of actual range as new span value if span valve is opened

SENO: Converter off

Command	Response	Description
_SENO_K0	_SENO_s	Set converter off Only NO is measured

SNOX: Converter on

Command	Response	Description
_SNOX_K0	_SNOX_s	Set converter on All kinds of NO _x are measured

SNO2: Converter on

Command	Response	Description
_SNO2_K0	_SNO2_s	Activates dual measure mode. Analyzer switches periodically between NO and NO _x mode and displays NO, NO ₂ , NO _x

SFGR: Reset calibration settings to factory default Converter on

Command	Response	Description
_SFGR_K0	_SFGR_s	Reset all calibration settings to their factory settings

SENT: Set calibration gas flow

Command	Response	Description
_SENT_K0_x	_SENT_s	x=10: Calibration through sample gas inlet (pump) y=11: Calibration through zero/span valves

13.6. Settings**EKAK:** The four span gas concentration values are set

Command	Response	Description
_EKAK_K0_M1_w.w_M2_x.x_M3_y.y_M4_z.z	_EKAK_s	Set end gas values

EMBE: The four measuring range end values are set

Command	Response	Description
_EMBE_K0_M1_w.w_M2_x.x_M3_y.y_M4_z.z	_EMBE_s	Set range limits

EMBU: The upper and the lower range switchover for autorange are set

Command	Response	Description
_EMBU_K0_M1_w.w_W.W_M2_x.x_X.X_M3_y.y_Y.Y_M4_z.z_Z.Z	_EMBU_s	Set lower and upper range switchover limits

EKEN: Set new device identification

Command	Response	Description
_EKEN_K0_new device-name	_EKEN_s	Set new device identification Maximum length of device name are 40 characters

NOTE: To change device identification, you must first rename the device to “RESET”. Now a name up to 40 letters can be given.

NOTE: The device name must not have any blanks between, i.e. “CAI CLD” is not allowed. You can use underlines, i.e. “CAI_CLD”.

EGRD: Set polynom coefficients

Command	Response	Description
_EGRD_K0_Mn_a0_a1_a2_a3_a4	_EGRD_s	Set polynom coefficients of range Mn

EFDA: Set autocalibration and purge times

Command	Response	Description
_EFDA_K0_SATK_z_y_x_w	_EFDA_s	Set autocalibration times: z= Purge time y=Calibration time x=Total calibration time w=Verify time (z,y,x,w in seconds)
_EFDA_K0_SSPL_z	_EFDA_s	Set analyzer purge time to z seconds

EPAR: Set autocalibration tolerance values

Command	Response	Description
_EPAR_K0_SATK_z.z_y.y_x.x_w.w	_EPAR_s	Autocalibration Tolerance value (%): z.z= Range 1 y.y= Range 2 x.x= Range 3 w.w= Range 4

ESYZ: Set System Time

Command	Response	Description
_ESYZ_K0_yymmdd_hhmmss	_ESYA_s	Respond system time: yymmdd:year, month, day (each 2 characters wide, no spaces) hhmmss: hour, minutes, seconds)

ET90: Set Lowpass Filter Time

Command	Response	Description
_ET90_K0_t	_ET90_s	Set lowpass filter time: t= filter time in seconds

EDAL: Diagnostic alarm limits

Command	Response	Description
_EDAL_K0_a1.min_a1.mas_..._a12max	_EDAL_s	Set all alarm limits
_EDAL_K0_x_x.min_xmax	_EDAL_s	Set alarm limits of x

Alarm Limits:

1	Sample Pressure	7	Cell Temp
2	Air Pressure	8	Peltier Gas Temp
3	Oven Temp	9	EPC Coil Sample Voltage
4	Converter Temp	10	EPC Coil Air/Ozone Voltage
5	Pump Temp	11	Reserved
6	Diode Temp	12	Sample Content

ETCP: Set TCP/IP Parameters

Command	Response	Description
_ETCP_K0_zzz.zzz.zzz.zzz	_ETCP_s	zzz= TCP/IP address
_ETCP_K0_yyy.yyy.yyy.yyy		yyy= TCP/IP subnet mask
_ETCP_K0_xxxx		xxxx= TCP/IP port
		All changes take effect after next power on cycle

13.7. Abbreviations used

Mn	: Measuring range number
M1 .. M4	: Measuring Range 1 .. 4
w.w .. Z.Z.	: Numerical value
x	: Number
t	: Numeric integer value
a0 .. a4	: Polynom coefficients
s	: Status
yyymmdd	:Date of format year, month and day with 2 characters each and no spaces
hhmmss	:Time of format hour, minute and second with 2 characters each and no spaces

14. Appendix

14.1. MODEL 650 NO_x/O₂ Flow Diagrams

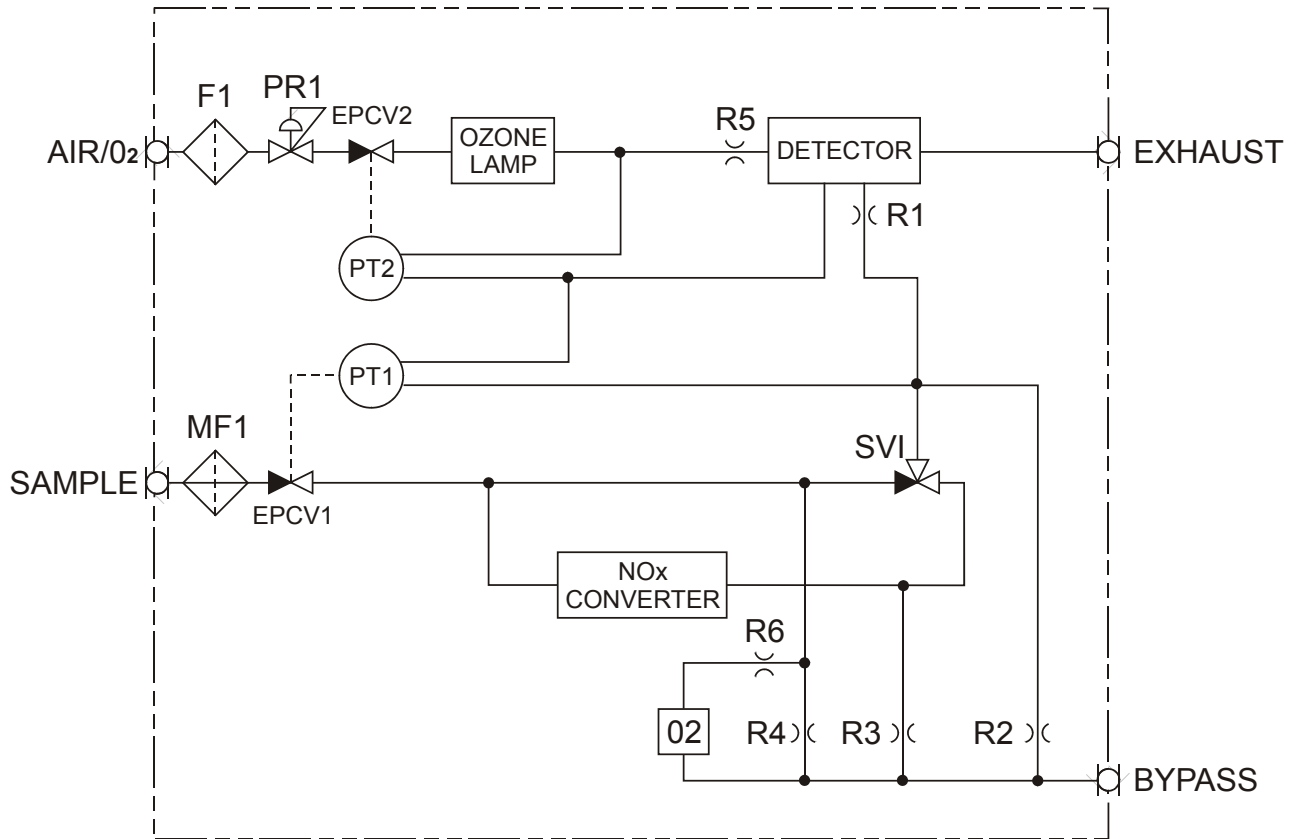

650 - NOXYGEN FLOW DIAGRAM

Figure 14-1: Standard Analyzer

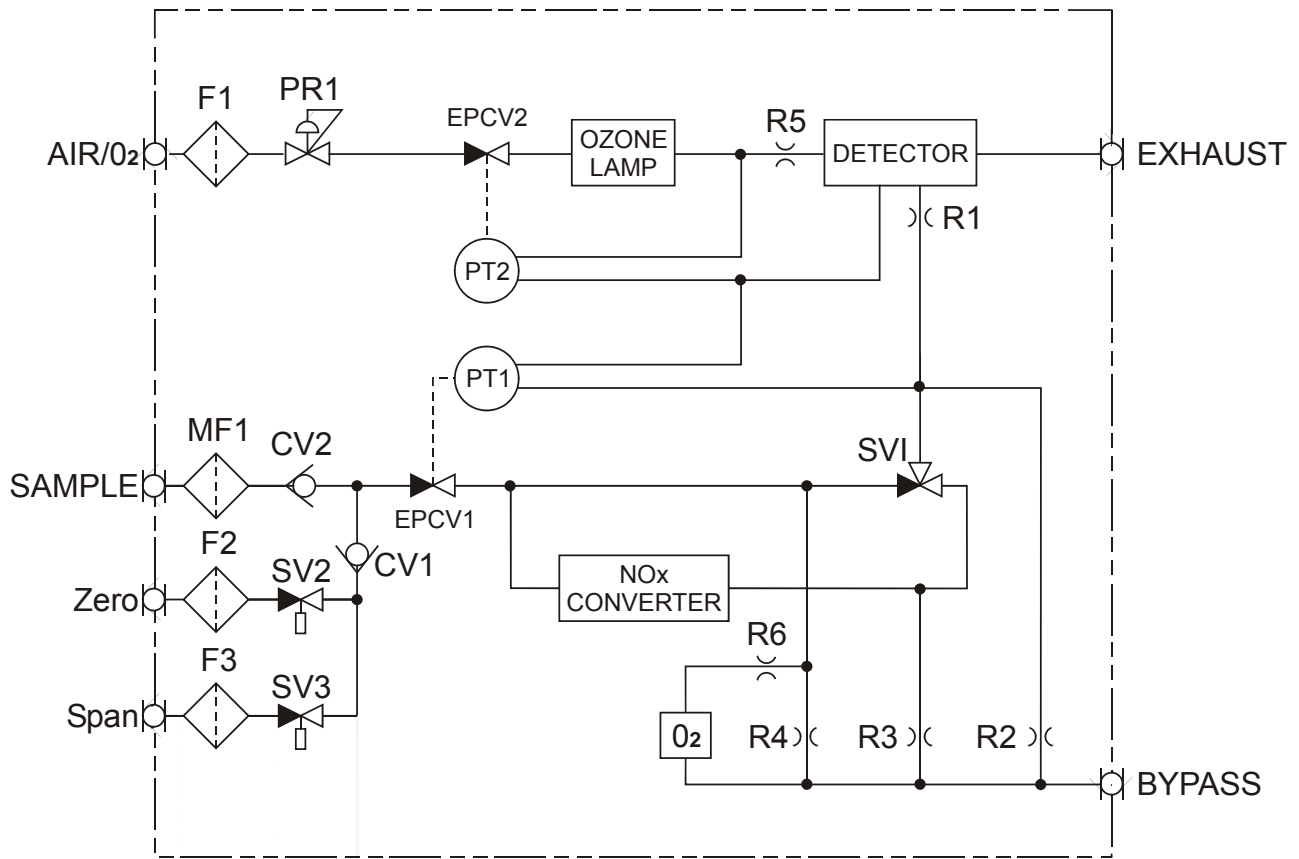

650 - NOXYGEN FLOW DIAGRAM - W/ZERO/SPAN S/V

Figure 14-2: Standard Analyzer with Optional Zero/Span Solenoids

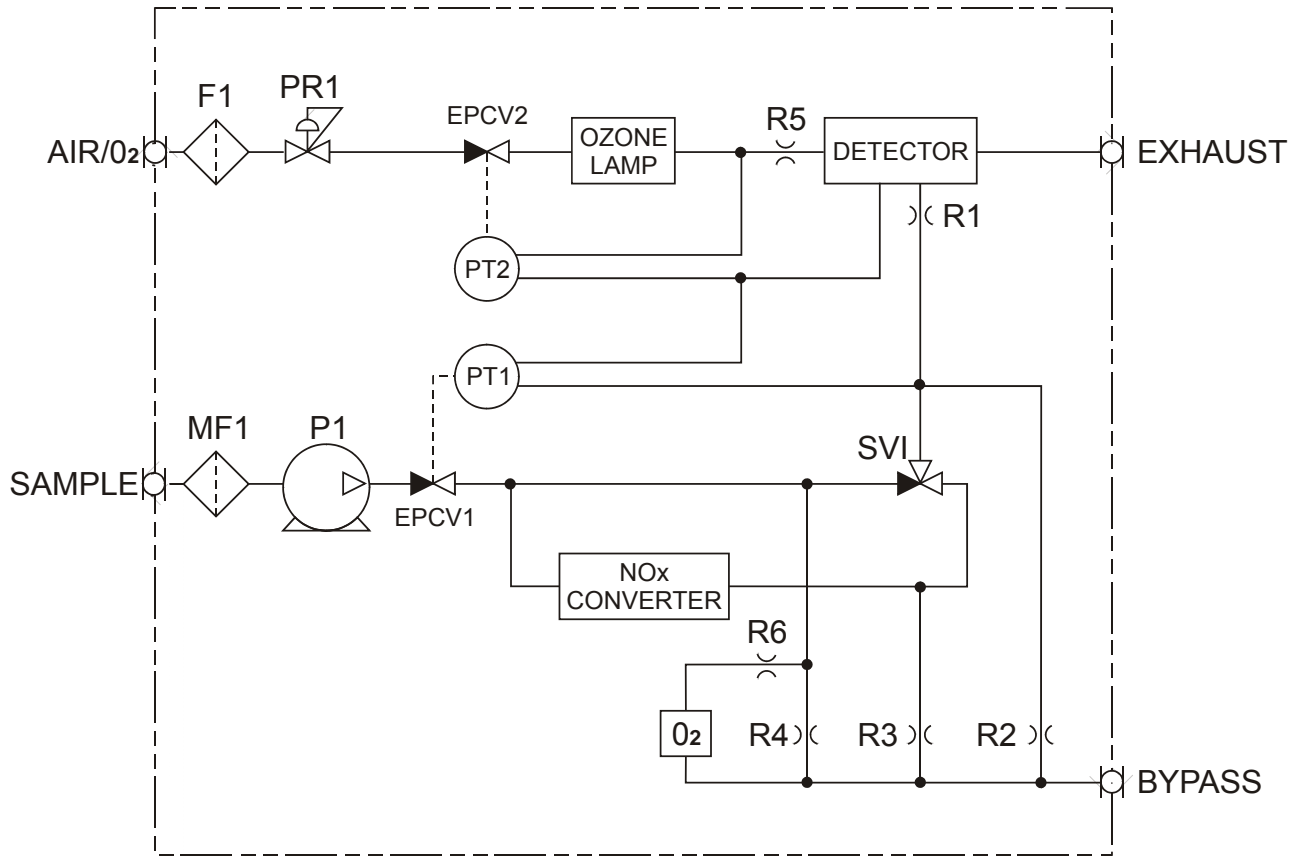

650 - NOXYGEN FLOW DIAGRAM - W/PUMP

Figure 14-3: Standard Analyzer with Optional Sample Pump

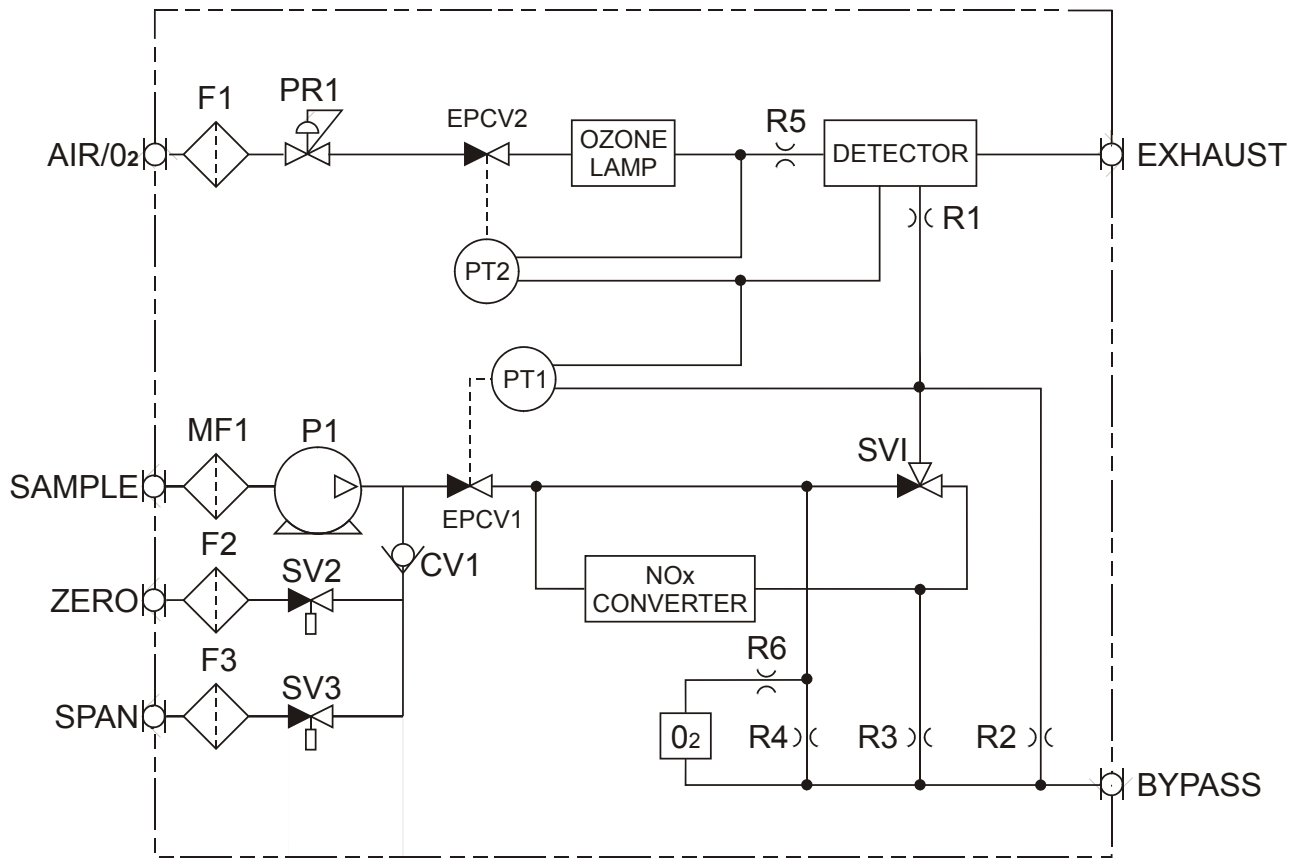

650 - NOXYGEN FLOW DIAGRAM W/PUMP AND ZERO/SPAN S/V

Figure 14-4: Standard Analyzer with Optional Sample Pump and Zero/Span Solenoids

TABLE OF CONTENTS

ADDENDUM

STARTING AFTER JUNE, 2007

<u>Section</u>	<u>Title</u>	<u>Page</u>
1.0.	Introduction -----	
2.0.	Operation of Measurement Keys -----	
	2.1. Over Range-----	
	2.2. Diagnostics-----	
	2.3. Zero-----	
	2.4. Span-----	
	2.5. Range Limits-----	
	2.6. Span Values-----	
	2.7. Outputs-----	
3.0	New Functions -----	
	3.1. Auto Start Up-----	
	3.2. Alarms On/Off-----	
	3.3. Offset & Gain-----	
	3.4. Calibrate The Analog Outputs-----	
	3.5. Save Data Archiving Time-----	
	TABLE A-----	
	3.6. User Digital Outputs-----	
	TABLE B-----	
	TABLE C-----	
	3.7. Cal Analog Output-----	
4.0.	Changes To Existing Functions -----	
	4.1. Saved or Outside Limits-----	
	4.2. Calibration Deviations-----	
	4.3. Flow Zero or Span Gas-----	
	4.4. Reset Calibration Values-----	
	TABLE D-----	

13.5 Starting With SERIAL NUMBER U06081

1.0 INTRODUCTION

The Model 600 CLD Series Instruments starting with Serial Number U06081 have several new Hardware and Software features.

The Hardware includes the use of a new memory system, isolation of the analog output signals and 15 relays that are used to buffer the many new digital output signals that are now available. **SEE TABLE D**

The available digital signals consist of a SERVICE group, to externally monitor a number of parameters that provide insight for preventative maintenance and diagnostics decisions.

A second STATUS group, is provided to define the operation of the instrument such as Spanning, Zeroing, Calibrating and the Current Range (1, 2, 3, 4, AUTO).

The Software includes modifications to existing functions, changes to the Measurement screen, additional Short-Cut Keys and several New Functions that are listed as follows:

- **MEASUREMENT**

Over Range	888888
Zero	F5
Span	F6
Range Limits	F8
Span Values	F9
Outputs	F10

Note: The operator can use these Short-Cut Keys or continue to use existing procedures.

- **NEW FUNCTIONS**

Auto Startup	F5, F7, F7
ALARMS	F5, F7, (Use F6 to toggle ON/OFF)
Offsets& Gains	F4, F3, F5
D/A Calibration	F5, F7, F8
Cal Analog Outputs	F5, F8, (Use F8 to toggle ON/OFF)
Save Data Archiving Time	F5, F7, F1, F5 (Use ENTER to change record time)
User Digital Outputs	F5, F9

- **MODIFICATIONS**

Saved/Not good	F4, F2, F1 or F2 (To flow Zero or Span Gas)
-----------------------	--

2.0 OPERATION OF MEASUREMENT KEYS

Note: The ← &→ Keys continue to be used to view a complete list of menu items.

2.1 Over Range 888888

In the MEASUREMENT mode only, any value that exceeds the “range” by more than 10% will be displayed as 888888.

2.2 Diagnostics: Use **F3** to toggle between MEASUREMENT and DIAGNOSTIC.

2.3 Zero: From the MEASUREMENT Screen select the required range for calibration then press **F5**.

Note: For instruments with an internal Zero Solenoid select Calibration by Valves. (**Main, F5, F2, F4**)

Manual Zero 4: SEND	Manual Zero 3: SMAN
Zero gas. Use F3 to Toggle Diagnostics. Cal Via	Zero gas. Use F3 To Toggle Diagnostics Cal Via *Using Current Temp & Press*
-375.00 NO	NOx 0.08 Range1: 100.0ppm
Range4: 3000ppm	
F1 Save value NO: -375.0	F1 Save value NOx: 0.1
F2 Man. Cal. Menu O2: 0.1 %	F2 Man. Cal. Menu O2: 0.0 %
Check Air EPC Coil V	Thu May 15 06:15:11 2008

2 versions

Zero Gas will be enabled and the observed results can be used to evaluate instrument performance.

Press **F3** to toggle to the Diagnostic screen for additional information

Press **F1** to save the value and complete a ZERO calibration for this channel and range

Press **MAIN, F1** to return to the MEASUREMENT screen to select other channels and ranges and repeat the process. Or press **F2** to return to the Manual Calibration Screen

2.4 Span: From the MEASUREMENT Screen select the required range then press **F6**.

Note: For instruments with an Internal Span Solenoid select Calibration by Valves. (**Main, F5, F2, F4**)

Manual Span		5: SWET			
Span gas. Use F3 to Toggle Diagnostics. Cal Via					
- 375.00					
NO		Conc.: 1860.00000			
Range4: 3000ppm					
F1 Save value			NO: -375.0		
F2 Man. Cal. Menu			O2: 0.1 %		

Manual Span		5: SWET			
Span gas. Use F3 To Toggle Diagnostics Cal Via *Using Current Temp & Press*					
0.00					
NOx		Conc.: 90.00000			
Range1: 100.0ppm					
F1 Save value			NOx: 0.0		
F2 Man. Cal. Menu			O2: 0.0 %		
CAI Tel. (800) 959 0959					

2 versions

Span Gas will be enabled and the observed results can be used to evaluate instrument performance.

Press **F3** to toggle to the Diagnostic screen for additional information

Press **F1** to save the new value and complete the SPAN calibration for this Range.

Note: The span gas value used for this range is highlighted and can be changed if necessary. Use the Enter key and the numeric keys as required

Press **MAIN, F1** to return to the MEASUREMENT screen to select other ranges and repeat the process or press **F2** to return to the Manual Calibration screen

2.5 Range Limits: F8 From the MEASUREMENT Screen;

Setup		5: SWET	
Upper range limits [ppm]			
*** MUST be ASCENDING ***			
RR	Range 1:	3.00	
RR	Range 2:	30.00	
RR	Range 3:	300.00	
RR	Range 4:	3000.00	
Do NOT Exceed Max Range			
		N0: -375.0	
		O2: 0.1 %	
Wed Jan 03 23:24:23 2001			

Setup		1: SARA	
Upper range limits [ppm]			
*** MUST be ASCENDING ***			
RR	Range 1:	100.00	
RR	Range 2:	500.00	
RR	Range 3:	1000.00	
RR	Range 4:	3000.00	
Maximum Range Limit: 3000.000			
F1 Save with new		N0x: 0.1	
autorange Up/Down		O2: 0.0 %	
CAI Tel. (800) 959 0959			

2 versions

The standard analyzer is factory configured with 4 Physical Ranges of 3, 30, 300, 3,000 PPM.

The optional high level analyzer is factory configured with 4 Physical Ranges of 5, 50, 500, 500

The operator can change the number of ranges and select a more convenient full scale concentration if required.

Note: Do not exceed the maximum range set by the factory and always use ascending order as shown.

Example a) For a single range instrument, set Range 1 to the desired value and all others to zero

b) For a two range instruments, set Range 1 to the lowest value, Range 2 to the highest value and the others to zero. .

2.6 Span Values: F9 From the MEASUREMENT Screen

Setup		1: SARA	
Span gas conc. range limits			
RR	Range 1:	2.250	3.00
RR	Range 2:	18.500	30.00
RR	Range 3:	186.500	300.00
RR	Range 4:	1860.000	3000.00
	O2:	0.000	
		N0: -375.0	
		O2: 0.1 %	
Check Sample EPC Coil U			

Use to define the concentration of the span gas that will be used to calibrate each range.

Note: The span gas value used for this range is highlighted and can be changed if necessary. Use the Enter key and the numeric keys as required.

2.7 Outputs: F10 From the MEASUREMENT Screen

Output	Signal
1	NO
2	NOx
3	NO2
4	RealTime

NOx: 11.3

CAI Tel. (800) 959 0959

Use the \uparrow to select the desired Output. Press Enter to select
Use the \downarrow to select the desired Signal. Press Enter to select

Use this screen to define the signals and their location that will be monitored by a remote reordering device.

Note: NO₂ only active in the "Switching Mode"

SEE TABLE D

3.0 NEW FUNCTIONS

3.1 Auto Start Up: (Main, F5, F7, F7)

Auto Startup		5: SWET	☰
•Auto Startup	:	Off	
•Wait for [min]	:	1	
•Calibrations	:	2	
•Startrange	:	4	
•Access Level	:	2	
•Remote/Manual	:	Manual	
•NO/NOx-Mode	:	NO	
MAIN SAVE		NOx: 22.5	
BACK SAVE			
Check Air Pressure			☒

All key analyzer parameters are stored in a secure memory location and retained when power is removed

In the event of an unexpected power failure it may be desirable to change some parameters until an operator can resume control.

This screen may be used to establish several desirable special instrument start-up parameters that define how the analyzer recovers from loss of AC power

When enabled this screen will define the following:

Wait: The time delay in minutes before proceeding. If “Zero” is selected the instrument will wait until all temperature warnings are cleared.

Calibrations: The number of attempts to complete a successful calibration as required in the operator defined Deviation Tables. If calibration is not successful the instrument will continue reporting results using the last completed calibration.

The analyzer will utilize the last completed calibration by selecting zero for Calibrations.

Starting Range: When all defined actions are completed the analyzer will return to the Measurement Screen and at the range specified.

Access Level: The user level at Start Up.

Remote/Manual: Put the analyzer in either “Remote” or “Manual” at Start Up

NO/NOx Mode: Put the analyzer in NO or NOx or NO2 mode at Start Up.

3.2 Alarms On/Off: (Main, F5, F7)

All key analyzer parameters are stored in a secure memory location and retained when power is removed. In the event of an unexpected power failure it may be desirable to change some parameters until an operator can resume control.

This screen may be used to establish several desirable special instrument start-up parameters that define how the analyzer recovers from loss of AC power.

When enabled this screen will define the following:

System setup		2: STBY	≡
F1	RealTime-Clock	»	
F2	TCP/IP settings		
F3	Output assignment		
F4	Output Range		
F5	status line on/off		
F6	Alarms on/off	On	
F7	Auto Startup		
F8	D/A calibration		
analyser Alarms		NOx: 43.7	
ON / OFF			
Check Air EPC Coil V			⏏

Use **F6** to toggle ON/OFF

The instrument has an extensive library of warning messages that will aid in the identification of various anomalous events and are displayed at the bottom of the screen. These messages will assist in diagnostics and indicating the need for preventative maintenance

This screen provides an **option** to disable these messages during initial start-up or as may be desired for a particular application.

3.3 Offset & Gain: (Main, F4, F3, F5)

Offset and Gain		
Zero/Span	applied	correction
Range	Offset	Gain
Range 1:	0.00	1.00
Range 2:	0.00	1.00
Range 3:	0.00	1.00
Range 4:	0.00	1.00
		N0: -0.8
Thu May 03 12:40:03 2007		

This screen can be used to provide an additional means to display calibration deviations.

The OFFSET is the value stored during zero calibration.

The GAIN is the value stored during span gas calibration using the operator defined calibration gas.

An increasing or decreasing change to the OFFSET or GAIN when used in conjunction with "Deviations" will provide insight to both short and long term changes to system performance

Note: Reset calibration values will reset OFFSETS & GAINS to zero and 1 respectively

3.4 Calibrate the Analog Outputs: (Main, F5, F7, F8) D/A Calibration (Main, F5, F7, F3) Output Assignment

- **Overview**

The 600 CLD Series is designed to provide four analog outputs that can be configured as 0-1 VDC, 0-5 VDC, 0-10 VDC, 4-20 mA, or 0-20 mA.

This screen (**Main, F5, F7, F8**) is used to select the scaling of the current (mA) or voltage (1, 5, 10) range that is required by a remote recording device. The outputs can be calibrated to exactly match the results obtained on a PLC, Recorder, Data Logger or other remote recording device that may be connected to the analyzer.

The operator will first select the **OUTPUT ASSIGNMENT (Main, F5, F7, F3)** screen and choose the output that is set to be calibrated. By selecting "calibrate" as the output all outputs of interest may be selected. When calibration is completed, the operator will return the outputs to their original assignment.

The **D-A CALIBRATION** screen will then be used to complete the calibration procedure.

```

output scaling  5:SDRY
-----
Calibrate D/A Outputs
Output Offset   Gain
-----
  1  1.8000    0.7000
  2  1.8000    0.7000
  3  1.8000    0.7000
  4  1.8000    0.7000
**Set Output-F3-Calibrate**
-----
MAIN / BACK SAVE  NO:  0.1
FS F1: 0% F5: 100%  O2:  0.0 %
-----
Mon Jan 01 01:13:03 2001
  
```

This screen provides a section that is used to record the zero signal corrections (zero offset) and a second area to record the 100% signal corrections (Gain) for each of the four output signals that may be defined to develop a voltage or current signal.

Since this is a Digital to Analog conversion, the calibration will require the completion of a simple “trial and error” procedure. The operator will observe the results of a “zero” or “span”(Gain) signal generated by the analyzer to the remote recording device and select a correction factor. The operator will save this value and then observe the results on the attached remote recording device.

The process of selection and saving for “zero” and “span” will be repeated until a satisfactory calibration is achieved. For 0-1VDC, 0-5VDC, 0-10VDC and a 0-20 mA outputs the Offset and Gain values are independent and do not interact. With the 4-20 mA output, the “Offset (zero)” and “Gain (span)” values interact and may require a few more trials.

The following is a table of typical values that can be used for start points for offsets and gains for different output types

OUTPUT	OFFSET	GAIN
0-20 ma	0.000	0.927
4-20 ma	1.820	0.740
0-1 V	1.300	0.820
0-5 V	1.100	0.820
0-10 V	1.050	0.820

- Procedure

3.4.1 From the Main Menu press **F5,F7,F3**, to obtain following screen:

assignment		1: SARA	⏏
Output	Signal		
1	NO		
2	NOx		
3	NO2		
4	SamplePres		
		NO: -375.0	
		O2: 0.1 %	

3.4.2. Use the \uparrow to highlight the outputs that require calibration.

3.4.3. Press enter so you provide access to all the menu of signals that are available.
(Real Time, NO, NOx, Calibration, Sample Pressure, etc.)

3.4.4. Select Calibration and press **ENTER** to complete the selection.
Note: In the example below only Output 1 will be calibrated
Record the name of these signals, they will be restored.

assignment		1: SARA	⏏
Output	Signal	mA	
1	Calibrate		
2	NOx		
3	NO2		
4	SamplePres		
		NO: 0.1	
		O2: 0.0 %	
CAI Tel. (800) 959 0959			

Note: Any or all of the four outputs can be selected for calibration. This screen will not be used again until calibration has been completed.

3.4.5. Press **BACK** to return to the SYSTEM SETUP screen (**Main,F5, F7**)

3.4.6. Press **F8** to obtain the following screen

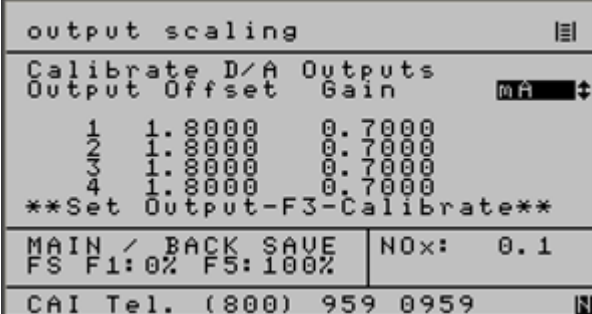

Calibrate	D/A	Outputs	
Output	Offset	Gain	mA
1	1.8000	0.7000	
2	1.8000	0.7000	
3	1.8000	0.7000	
4	1.8000	0.7000	

Set Output-F3-Calibrate

MAIN / BACK SAVE	NOx: 0.1
FS F1: 0% F5: 100%	

CAI Tel. (800) 959 0959

Main, F5, F7, F8

3.4.7. Use the \uparrow to select the desired output press **ENTER**.

3.4.8. Press **F1** to select a ZERO signal and observe the results on the remote device

3.4.9. Change the offset value press **BACK** to save the new value.

3.4.10. Press **F8** to return to the D-A Calibration screen and note the results on the remote device.

3.4.11. Repeat steps 3.4.8 thru 3.4.10 until a satisfactory ZERO calibration is achieved.

3.4.12. Complete steps 3.4.8 thru 3.4.10 for each of the remaining outputs that require calibration.

3.4.13. Press **F5** to produce a full scale (100%) signal.

3.4.14. Use the arrow keys to position the cursor at the require GAIN value.

3.4.15. Observe the results on the remote device and make a correction to the GAIN value for the output of interest. Press **BACK** to save this new value

3.4.16. Press **F8** to return to the D-A calibration screen

3.4.17. Observe the results on the remote device and repeat the steps to change the GAIN value by repeating steps 3.4.14 thru 3.4.16 as needed for each output.

3.4.18. Return to the OUTPUT Assignment screen **F5, F7, F3** from the main menu and change the output signals from CALIBRATE to their original values as defined in step 3.4.1.

3.5 Save Data Archiving Time (Main, F5, F7, F1, F5)

Archive Time is the Time in seconds between each set of data points. If “zero” no data is stored in the SEC data files. The SEC data files are in .CSV format for direct import into Excel. CAI can provide the tools necessary to download these files.

Setup RTC		3: SMAN	☰
F1	Set time		
F2	Set autocalibration time		
F3	Select calibration range		
F4	Autocalibration on/off		
F5	Save Data Archiving Time		
	Archive Time(secs)	10	
F10	Show time		
Archive Interval		N0: -286.8	
0 = Off	F5: SAVE	02: 0.1 %	

Use ENTER to change recording time

SEE TABLE A

TABLE A**600 SERIES CLD DATA ARCHIVE FILES**

Time,
Date,
Month,
Year,
Error Index,
TimeStamp,
NO Conc,
NO2 Conc,
NOx Conc,
NH3 Conc,
Concentration,
Detector Volts,
Range,
Auto / Manual,
Span Gas,
Offset,
Gain,
Sample Pressure,
Sample Flow,
Sample EPV Volts,
Air Pressure,
Ozone Flow,
Ozone EPC Volts,
Diode Temp,
Cell Temp,
Oven Temp,
Pump Temp,
Converter Temp,
Dryer Temp,
O2 Detector Temp,
NH3 Conv Temp,
O2 Concentration,
O2 Detector Volts,
O2 Offset,
O2 Gain,
Wet / Dry,
Meas Mode,
Local / Remote,
Converter

3.6 User Digital Outputs

- **Overview**

The 600 CLD Series of instruments have 15 solid state, optically coupled, isolated relays that can be programmed by the operator to indicate the status of numerous digital conditions

The available digital signals consist of a SERVICE group, that can be used to externally monitor a number of conditions to aid in preventative maintenance and diagnostics. **SEE TABLE B & D**

A second STATUS group, is provided and is used to define the operation of the instrument such as Spanning, Zeroing, Calibrating and the current Range (1, 2, 3, 4, AUTO) etc. **SEE TABLE C & D**

The individual output signals can be operator selected and set to a **HOLD** or **CLEAR** mode.

In the **HOLD** mode an activated signal is retained until the operator returns to the **Digital Output Screen** and selects the appropriate output signal and performs a manual CLEAR. After performing a Clear Operation, the operator must press F2 again to put the outputs back into the Hold mode.

User DO I		4: SENO	☰
1	Off		
2	Off		
3	Off		
4	Off	*****	
5	Off	*Set Unused *	
6	Off	*Channels Off*	
7	Off	*****	
F2	Hold / Clear		
F1 8 to 15 DO's		NO: 0.1	
MAIN/BACK to SAVE		O2: 0.0 %	
Mon Jan 01 01:40:39 2001			

In the **CLEAR** mode the signal will automatically change state when the microprocessor detects that the noted condition no longer exists.

User DO II		5: SDRY	☰
8	Off		
9	Off		
10	Off		
11	Off	*****	
12	Off	*Set Unused *	
13	Off	*Channels Off*	
14	Off	*****	
15	Off		
F1 1 to 7 DO's		NO: 0.1	
MAIN/BACK to SAVE		O2: 0.0 %	
CAI Tel. (800) 959 0959			

The operator can select from the following the desired **SERVICE** or **STATUS** groups that are to be digitally monitored.

TABLE B

Index	Service Group	User DO Screen Display
0		
1	Sample Pressure Failure	SampleP
2	Air Pressure Failure	AirP
3	Oven Temp Failure (hclid only)	OvenT
4	Converter Temp Failure	ConvT
5	Pump Temp Failure	PumpT
6	Diode Temp Failure	DiodeT
7	Cell Temp Failure	CellT
8	Peltier Gas Temp Failure (hclid only)	DryT
9	O2 Temp Failure (650 only)	O2T
10	EPC Coil Sample Failure	SEV
11	EPC Coil Air Failure	AEV
12	Range overflow	OR
13	ADC Range Overflow	AO
14	ADC Range Underflow	AU
15	Range 1 is not calibrated	R1NC
16	Range 2 is not calibrated	R2NC
17	Range 3 is not calibrated	R3NC
18	Range 4 is not calibrated	R4NC
19	Reaction chamber pressure	RCP
20	Low concentration Warning	LoC
21	High concentration Warning	HiC
22	NH3 Converter Temp Failure (605 only)	NH3T
23	dummy text for RTC	Off
24	General Alarm	GenAlarm
26	Cal Alarm	CalAlarm

TABLE C

Index	Status Group	User DO Screen Display
25	In Remote	InRem
27	AutoRange	AutoR
28	Range 1	R1
29	Range 2	R2
30	Range 3	R3
31	Range 4	R4
32	In Calibrate	InCal
33	In Zero	Zero
34	In Span	Span
35	In Sample	Sample
36	In NO Mode	InNO
37	In NOx Mode (605 only)	InNOx
38	In Wet Mode (HCLD only)	InWet
39	In Overflow (not used)	InOflow
40	In NH3 Mode (605 only)	InNH3

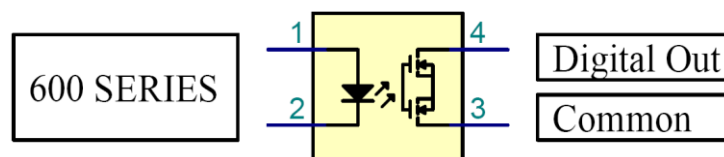
TYPICAL RELAY

These contacts (3, 4) will drive continuously up to 500 MA using a customer voltage supply that does not to exceed 60 VDC.

• **OPERATION**

Use **(Main, F5, F9)** to select the first seven outputs.
 Use the \uparrow to select the desired output.
 Press ENTER and use \uparrow to select desired item.
 Press ENTER to save selection

Note: The 600 CLD has 15 user selectable isolated digital outputs from the list of 40 in **TABLE B & C**

User DO I	4: SEND	☰
1	Off	
2	Off	
3	Off	
4	Off	*****
5	Off	*Set Unused *
6	Off	*Channels Off*
7	Off	*****
F2 Hold / Clear		
F1 8 to 15 DO's		NO: 0.1
MAIN/BACK to SAVE		O2: 0.0 %
Mon Jan 01 01:40:39 2001		

Press **F1** to observe the remaining eight outputs
 Program as desired per the above

User DO II	5: SDRY	☰
8	Off	
9	Off	
10	Off	
11	Off	*****
12	Off	*Set Unused *
13	Off	*Channels Off*
14	Off	*****
15	Off	
F1 1 to 7 DO's		NO: 0.1
MAIN/BACK to SAVE		O2: 0.0 %
CAI Tel. (800) 959 0959		

3.7 Cal Analog Output: (Main, F5, F8,)

Measure setup 4: SENO	
F1	Lowpass filter Tc
F2	Purge time
F3	T + P compensation
F4	Set dual-mode times
F8	Cal Analog Out On
F9	Ignite on power up
set analog out during cal	NO: 42.5
Tue May 15 08:47:49 2007	

Use F8 to toggle on/off

Normally, during Auto Cal the Sample and Hold Outputs NO, NOx and NO2 are held at the last process value. If Cal Analog Output is set "On" then the values are not held, and the Real Time value is Output.

4.0 CHANGES TO EXISTING FUNCTIONS

4.1 Saved or Outside Limits

During Manual Calibration the following screens will be displayed to indicate the instruments response to the value of the zero or span gas using the amount that the operator defined in the deviation table.

Manual Zero 3:SMAN	
Zero gas. Use F3 To Toggle Diagnostics Cal Via *Using Current Temp & Press* ***Saved Current***	
NOx - 0.00 Range1: 100.0ppm	
F1 Save value	NOx: -0.0
F2 Man. Cal. Menu	O2: 0.0 %
Thu May 15 06:16:17 2008	

Manual Span 1:SARA	
Span gas. Use F3 To Toggle Diagnostics Cal Via *Using Current Temp & Press* Outside Deviation Limits	
NOx 0.08 Range1: 100.0ppm	
F1 Save value	NOx: 0.1
F2 Man. Cal. Menu	O2: 0.0 %
Thu May 15 06:18:22 2008	

The above is shown using Zero Gas

From Measurement use: **F5 “Zero” or F6 “Span”**
From Main Menu use: **F4, F2, F1 “Zero” or F2 “Span”**

4.2 Calibration Deviations.

MAIN, F5, F2, F2 Deviations, F3 Measuring Deviations.

Setup 5: SWET			Setup 1: SARA		
Deviations[%]			Measuring deviation[%]		
	absolute	relative			
Range1:	10.00	10.00	Range1:	1.00	
Range2:	10.00	10.00	Range2:	1.00	
Range3:	10.00	10.00	Range3:	1.00	
Range4:	10.00	10.00	Range4:	1.00	
NOx: -0.0			NOx: 0.0		

Note: These screens are used by the operator to define the maximum acceptable limits of the Zero and Span gas for both Manual and Automatic Calibrating.

4.3 Flow Zero or Span

Some analyzers have the above and the ability to flow Zero and Span Gas.

Manual calib 3: SMAN		Manual calib 1: SARA	
F1 Cal zero	0.08	F1 Cal zero	0.08
F2 Cal span	ZERO	F2 Cal span	SPAN
F3 Toggle zero		F3 Toggle zero	
F4 Toggle span		F4 Toggle span	
F5 Measurements		F5 Measurements	
F6 Cal zero 02		F6 Cal zero 02	
F7 Cal span 02		F7 Cal span 02	
F8 Range Up **	F7 Range Down	F8 Range Up **	F7 Range Down
Range1: 100.0ppm	NOx: 0.1	Range1: 100.0ppm	NOx: 0.1
	O2: 0.0 %		O2: 0.0 %
CAI Tel. (800) 959 0959		Thu May 15 06:22:23 2008	

The above is shown using Zero/SPAN Gas

- From Cal Screen use: **F2 or Main or Back**
- From Main Menu use: **F4, F2**

4.4 Reset Calibration Values

When the re-set calibrations value function is used all recorded deviations will be set to zero

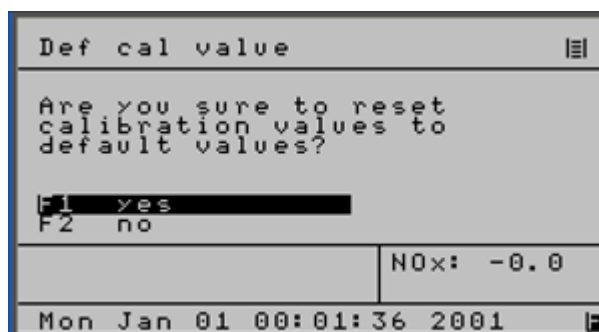

Main, F4,F5

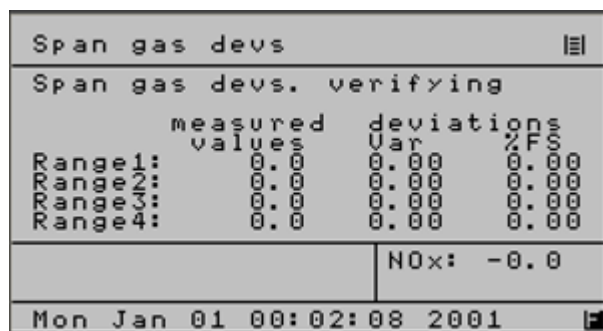

Main,F4 F3, F4
(Used to observe Auto Cal Results)

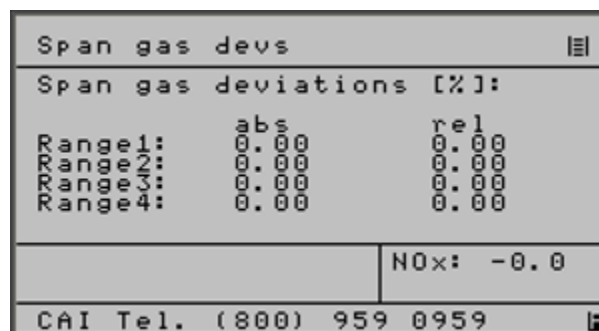

Main, F4, F3, F2
(Used to observe Manual Cal results)

The above are the new deviations after the operator elects to re-set the calibration values

TABLE D**600 SERIES CLD IO CHART****28 PIN MAIN CONNECTOR ASSIGNMENTS**

AO = Analog Output, OC= Open Collector, SV = Solenoid Valve TTL = Transistor Logic

OPTO I/O	Signal Type	600 CLD/HCLD Analog		Levels
ALG 1		pin #		
COM	A Output	1	GND (Isolated analog)	<u>Isolated AI</u>
0	A Output	2	User Defined AO-1	1v,5v,10v,mA
1	A Output	3	User Defined AO-2	1v,5v,10v,mA
2	A Output	4	User Defined AO-3	1v,5v,10v,mA
3	A Output	5	User Defined AO-4	1v,5v,10v,mA
DIG 1		Digital		
COM	D Output	6	GND (Digital)	
0	D Output	7	Sense Auto Range	TTL-low true
1	D Output	8	Sense Range 1	TTL-low true
2	D Output	9	Sense Range 2	TTL-low true
3	D Output	10	Sense Range 3	TTL-low true
	D Output	11	Sense Range 4	TTL-low true
5	D Input	12	Set Auto Range	
6	D Input	13	Control Range 1	
7	D Input	14	Control Range 2	
8	D Input	15	Control Range 3	
9	D Input	16	Control Range 4	
10	D Input	17	Auto Cal	
11	D Input	18	Calibrate	
12	D Input	19	Zero	
13	D Input	20	Span	
14	D Input	21	Sample	
15	SPARE			
DIG 2				
0	D Output	22	Zero Gas Flow	OC (24vdc if internal SV)
1	D Output	23	Span Gas Flow	OC (24vdc if internal SV)
2	D Output	24	Sample Gas Flow	OC (24vdc if internal SV)
3	D Output	25	Local/Remote	TTL-low true
4	D Output	26	Read Cal Mode	TTL-low true
5	D Output	27	Reserved	
6	D Output	28	Reserved	

TABLE D (CONT)**600 SERIES CLD IO CHART****28 PIN AUXILLIARY CONNECTOR ASSIGNMENTS****NO = Normally Open**

OPTO I/O	Signal Type	CLD Analog		LEVELS
ALG 1	Spare	pin #		
COM 4	A Input	1	GND (analog)	0-10V 0-10V 9,10,11,12 use RTN 1
5	A Input	2	External Analog 1	
6	A Input	3	External Analog 2	
7	A Output	4	GND (Isolated analog)	
	D Output	5	Relay RTN 1	
DIG 3	Alarms	Digital		Status go CLOSED when active Alarms go OPEN when present
COM 0	D Output	6	Relay RTN 2	13,14,15,16 use RTN 2 17,18,19,20 use RTN 3 21,27,28 use RTN 4
1	D Output	7	Relay RTN 3	
2	D Output	8	Relay RTN 4	
3	D Output	9	User Defined NO Relay 1	
4	D Output	10	User Defined NO Relay 2	
5	D Output	11	User Defined NO Relay 3	
6	D Output	12	User Defined NO Relay 4	
7	D Output	13	User Defined NO Relay 5	
	D Output	14	User Defined NO Relay 6	
8	D Output	15	User Defined NO Relay 7	
9	D Output	16	User Defined NO Relay 8	
10	D Output	17	User Defined NO Relay 9	
11	D Output	18	User Defined NO Relay 10	
12	D Output	19	User Defined NO Relay 11	
13	D Output	20	User Defined NO Relay 12	
14	D Output	21	User Defined NO Relay 13	
15	D Output	22	Reserved Do Not Connect	
DIG 2				
7	D Input	23	Set Wet Mode	
8	D Input	24	Set Overflow	
9	D Input	25	Set NO Mode	
10	D Input	26	Set Remote	
11	D Output	27	User Defined NO Relay 14	
12	D Output	28	User Defined NO Relay 15	