

# 600

SERIES

# NDIR/O<sub>2</sub>



## USER'S MANUAL

**Note: For Analyzers Sold After June, 2007 Please See Addendum Starting After Page 89 of This Manual**



1312 West Grove Avenue  
Orange, CA 92865-4134  
Phone: 714-974-5560 Fax: 714-921-2531  
[www.gasanalyzers.com](http://www.gasanalyzers.com)



Safety Alert  
Caution or Warning



Temperature Hazard  
Caution or Warning



Electrical Shock Hazard  
Caution or Warning

## Safety Information in this Manual

Note, caution and warning symbols appear on the instrument and throughout this manual to draw your attention to important operational and safety information.

A “**NOTE**” marks a short message to alert you to an important detail.

A “**CAUTION**” safety alert appears with information that is important for protecting your equipment and performance.

A “**WARNING**” safety alert appears with information that is important for protecting you, others and equipment from damage. Pay very close attention to all warnings that apply to your application.



The  symbol (an exclamation point in a triangle) precedes a general CAUTION or WARNING statement.



The  symbol (wavy vertical lines with an underline in a triangle) precedes an elevated temperature hazard CAUTION or WARNING statement.



The  symbol (a lightning bolt in a triangle) precedes an electric shock hazard CAUTION or WARNING statement.

Some or all of the above symbols may appear in this manual or on the equipment. This manual should be consulted whenever one of these symbols is encountered on the equipment.

**ALWAYS REMOVE POWER BEFORE CONNECTING OR DISCONNECTING SIGNAL CABLES OR WHEN SERVICING THE EQUIPMENT.**

**The 600 series NDIR instruments meet or exceed the following directives and standards.**

Application of Council Directive(s):

*Electrical Safety:*

Low Voltage Directive 73/23/EEC

*Electromagnetic Compatibility:*

EMC Directive 89/336/EEC

Standard(s) to which Conformity is Declared:

*Electrical Safety:*

*Standard for Electrical Equipment for Measurement, Control, and Laboratory Use [EN 61010-1:2001 (2nd Edition)*

*Electromagnetic Compatibility:*

*EN 61326:1997 Electrical equipment for measurement, control and laboratory use - EMC requirements (Amendment A1: 1998 to EN 61326:1997; Amendment A2:2001 to EN 61326:1997)*

## 600 NDIR Quick Start Guide

- 1) Plug in the analyzer and turn the power on.
- 2) Connect the appropriate gas lines and vents to the analyzer.
- 3) Allow the analyzer to stabilize for at least one (1) hour.
- 4) During the analyzer's stabilization period, setup the analyzer to the desired configuration.
  - a) Set the analyzer's output as desired.
    - i) From the Main Menu press F5 (Setup) then F7 (System Settings.)
    - ii) Press F3 (output assignments) to setup the output channels.
      - (1) Set to real time.
      - (2) AUX 1
      - (3) AUX 2
      - (4) AUX 3
      - (5) Press back to return to the system settings menu.
    - iii) Press F4 (output range) to setup the output ranges
      - (1) Set the Min and Max to zero (0). This will cause the outputs to default to the current ranges.
      - (2) Set the outputs for milliamps (mA) or voltage (V) as desired.
        - (a) The mA setting will give 4-20 mA or 2-10V (if 500 ohm resistors are installed).
        - (b) The V setting will give 0-20mA or 0-10V (if 500 ohm resistors are installed).



### **Disconnect power before proceeding**

- 5) Connect all appropriate analog outputs.
  - a) Pin 1 is the output common (ground).
  - b) Pins 2, 3, 4, and 5 are output channels 1, 2, 3, and 4 as setup in step 4.a.ii.
  - c) If the output is set for voltages but there is no voltage output, you will need to install a 500 ohm resistor between pin 1 and the channel you are trying to measure. You will have to measure the voltage drop across this resistor.
- 6) Reconnect the power and turn on the analyzer. Press F1 from the analyzer's main Menu to get to the measurement screen.
- 7) Supply sample gas to the analyzer.

- 8) The measurement screen should indicate the concentration of the sample gas. If the concentration is incorrect, the analyzer will need to be calibrated using zero and span calibration gases. Please reference the appropriate section of the manual for a description on how to zero and span the analyzer.

---

## TABLE OF CONTENTS

<b>1. Introduction.....</b>	<b>15</b>
1.1. Overview.....	15
1.2. Unpacking Instructions .....	15
1.3. Reporting Damage .....	15
1.4. Contact Information .....	15
1.5. Warranty Certificate.....	16
1.6. Possible Explosion Hazard .....	17
1.7. Electrical Shock Hazard.....	17
1.8. Plug Removal .....	17
<b>2. Features.....</b>	<b>18</b>
2.1. Description.....	18
2.2. Features-General .....	18
2.3. Features-General .....	18
2.4. Infrared Gas Analyzers .....	19
2.5. Interference Gases .....	20
2.6. Electronics .....	21
2.7. Model 600 NDIR Specifications .....	22
2.8. Model 600 NDIR Features .....	22
<b>3. Installation.....</b>	<b>23</b>
3.1. General.....	23
3.2. Site and Mounting.....	23
3.3. Electrical.....	23
3.4. Analog Output Connections (Appendix).....	24
3.5. Gases .....	24
3.6. Gas Handling Equipment.....	25
3.7. Gas Connections .....	25
3.8. Sampling Requirements .....	25
3.8.1. Filtration .....	25
3.8.2. Condensation .....	25
3.8.3. Presence of Corrosive Gases.....	25
3.8.4. Gas Temperature .....	25

---

3.8.5.	Sample Gas Bypass Outlet (Vent).....	25
<b>4.</b>	<b>Basic Operation .....</b>	<b>26</b>
4.1.	Display.....	26
4.2.	Menu Trees .....	27
4.3.	Keyboard .....	30
4.3.1.	Operation with the Cursor Keys and the Enter Key .....	30
4.3.2.	Operation with the Function Keys.....	30
4.3.3.	Read/Change Parameters.....	30
<b>5.</b>	<b>Operating Structure.....</b>	<b>31</b>
5.1.	The Main Menu.....	32
<b>6.</b>	<b>Menu Structure .....</b>	<b>33</b>
6.1.	User Functions (Level 1).....	33
6.2.	Advanced User Functions (Level 2).....	33
6.3.	Maintenance Functions (Level 3).....	33
6.4.	System User Functions (Level 4).....	33
<b>7.</b>	<b>Main Menu Function Descriptions.....</b>	<b>34</b>
7.1.	F1 Measurements.....	34
7.1.1.	F1 Measurement.....	34
7.1.2.	Range Select.....	35
7.2.	F2 Purge Analyzer .....	36
7.3.	F3 Diagnostics.....	36
7.4.	F4 Calibrations .....	37
7.4.1.	F1 Automatic Calibration .....	37
7.4.2.	F2 Manual Calibration .....	38
7.4.3.	Display Deviations – from Calibration menu F3.....	39
7.4.4.	Absolute Zero Gas Deviation.....	39
7.4.5.	Relative Zero Gas Deviation.....	39
7.4.6.	Absolute Span Gas Deviation.....	40
7.4.7.	Relative Span Gas Deviation.....	40
7.4.8.	F4 Check Calibration.....	40
7.4.9.	F5 Reset Calibration Values.....	40
7.4.10.	F6 Range Select .....	40

---

7.5.	F5 Setup.....	41
7.5.1.	F1 Span Gas Concentration.....	41
7.5.2.	Calibration Settings.....	42
7.5.3.	F1 Times.....	42
7.5.4.	F2 Measuring Deviations.....	42
7.5.5.	F3 Deviations.....	42
7.5.6.	F3 Range Limits.....	42
7.5.7.	F1 Range 1-4 (Change Upper Range Limits).....	43
7.5.8.	F2 Change Auto Range Limits.....	43
7.5.9.	F4 Alarms.....	44
7.5.10.	F5 Password.....	44
7.5.11.	F1 Enter Password.....	45
7.5.12.	F2 Change Password.....	45
7.5.13.	F3 Reset Passwords.....	45
7.5.14.	F6 Linearization.....	46
7.6.	F7 System Settings.....	47
7.6.1.	F1 Real Time Clock.....	47
7.6.2.	System Setup F2 Displays TCP/IP Address.....	49
7.6.3.	Systems Setup F3 Displays Output Signal Assignments.....	49
7.6.4.	System Setup F4 Displays Output Ranges.....	49
7.6.5.	F5 Turns Status Line On or Off.....	50
7.6.6.	F8 Measure Settings.....	50
7.6.7.	F1 Set Lowpass filter.....	50
7.6.8.	F2 Purge Time.....	51
7.6.9.	F3 Set Temperature Compensation.....	51
7.6.10.	F4 Pressure Compensation.....	51
7.6.11.	F3 Low Pass Filter Time Constant.....	51
7.6.12.	F10 Displays the Current Analyzer and Software Versions.....	52
7.7.	F7 Remote / Manual Control.....	52
7.8.	F8 Standby.....	53
<b>8.</b>	<b>Analyzer Components.....</b>	<b>54</b>
8.1.	Rear Panel.....	54
8.2.	Rear Panel Connectors.....	56



---

8.3.	Digital Outputs .....	57
8.3.1.	RS-232 (Standard 9 Pin DIN Connector).....	57
8.3.2.	TCP/IP (8 Pin RJ-47 Connector) .....	57
8.4.	Internal Component Locations .....	58
8.5.	Main Electronics Board (Potentiometers).....	60
8.6.	NDIR Detector Assembly .....	61
<b>9.</b>	<b>Operation.....</b>	<b>62</b>
9.1.	External Wiring .....	62
9.2.	External Piping .....	62
9.3.	Operation & Calibration .....	62
9.3.1.	Power On: .....	62
9.3.2.	Zero/San Adjustment: .....	62
9.3.3.	Start-Up and Routine Maintenance: .....	62
<b>10.</b>	<b>MAINTENANCE .....</b>	<b>63</b>
10.1.	Zero and Span Calibration .....	63
10.2.	Cleaning of the Optical Bench Measuring Cell (Infrared Analyzers Only).....	63
10.3.	Optical Bench Configuration .....	63
10.4.	Removal of Pipe Cell .....	65
10.5.	Removal of Block Cell.....	67
10.6.	Disassembly of Combination Pipe & Block Type Cells.....	69
<b>11.</b>	<b>ADJUSTMENTS CHECKS AND REPAIRS .....</b>	<b>71</b>
11.1.	Adjustment of Detector Voltage (NDIR'S only).....	71
11.2.	Coarse Zero Adjustment.....	71
11.3.	Span Gain Adjustment.....	71
11.4.	Check and Repair Detector .....	72
11.4.1.	Problem:.....	72
11.4.2.	Symptom:.....	72
11.4.3.	Check and/or replace: .....	72
11.5.	Check and Repair Infrared Light Source Unit .....	73
11.5.1.	Problem:.....	73
11.5.2.	Symptom:.....	73
11.5.3.	Check and/or replace: .....	73
11.6.	Check and Replace Chopper.....	73

---

11.6.1.	Problem:.....	73
11.6.2.	Symptom:.....	73
11.6.3.	Check and/or replace:.....	73
11.7.	Check and Repair Measuring Cell .....	74
11.7.1.	Problem:.....	74
11.7.2.	Symptom:.....	74
11.7.3.	Check and or replace:.....	74
11.8.	Check and Repair Tubing Trouble .....	74
11.8.1.	Problem:.....	74
11.8.2.	Symptom.....	74
11.8.3.	Check and/or replace:.....	74
11.9.	Check and Repair Amplifier Circuit .....	75
<b>12.</b>	<b>Communication Master Computer / Analyzer (AK Protocol) .....</b>	<b>76</b>
12.1.	Serial Interface and AK-Commands .....	76
12.2.	Interface Specifications.....	76
12.3.	Protocol Description.....	77
12.3.1.	Instruction command.....	77
12.3.2.	Acknowledgement command .....	77
12.3.3.	Data Description.....	78
12.3.4.	Error Handling.....	78
12.4.	Scan Commands .....	79
12.4.1.	<b>AKON:</b> Measured concentration value .....	79
12.4.2.	<b>AEMB:</b> Get measuring range .....	79
12.4.3.	<b>AMBE:</b> Measuring range limit .....	79
12.4.4.	<b>AKAK:</b> Calibration gas concentrations .....	79
12.4.5.	<b>AMBU:</b> Upper and lower range switchover values for auto range .....	79
12.4.6.	<b>ASTZ:</b> Normal device status.....	80
12.4.7.	<b>ASTF:</b> Error status .....	80
12.4.8.	<b>AKEN:</b> Device identification .....	80
12.4.9.	<b>ARMU:</b> Raw value.....	80
12.4.10.	<b>ATEM:</b> Temperatures.....	81
12.4.11.	<b>ADRU:</b> Pressures/ Valve voltage .....	81
12.4.12.	<b>ADUF:</b> Flows.....	81

12.4.13.	<b>AGRD:</b> Polynom coefficients .....	81
12.4.14.	<b>AANG:</b> Deviation from zero point after autocalibration .....	81
12.4.15.	<b>AAEG:</b> Deviation from end point after autocalibration .....	81
12.4.16.	<b>AFDA:</b> Purge and Autocalibration times .....	81
12.4.17.	<b>APAR:</b> Request Autocalibration tolerance values.....	82
12.4.18.	<b>AKAL:</b> Deviations from calibration .....	82
12.4.19.	<b>ASYZ:</b> Respond System Time.....	82
12.4.20.	<b>AT90:</b> Respond Lowpass filter time.....	82
12.4.21.	<b>ADAL:</b> Diagnostic alarm limits.....	82
12.4.22.	<b>ATCP:</b> Query TCP/IP settings.....	82
12.4.23.	<b>AVER:</b> Query Software version .....	83
12.4.24.	<b>AH2O:</b> Query H <sub>2</sub> O correction parameter .....	83
12.4.25.	<b>ACO2:</b> Query CO <sub>2</sub> correction parameter .....	83
12.4.26.	<b>AUPD:</b> Query UDP data streaming parameter .....	83
12.5.	Control commands .....	84
12.5.1.	<b>SRES:</b> Reset.....	84
12.5.2.	<b>SPAU:</b> Pause .....	84
12.5.3.	<b>STBY:</b> Standby .....	84
12.5.4.	<b>SNGA:</b> Open valve for zero gas calibration .....	84
12.5.5.	<b>SEGA:</b> Open valve for end gas calibration .....	84
12.5.6.	<b>SSPL:</b> Purge Analyzer with zero gas .....	84
12.5.7.	<b>SATK:</b> Start automatic calibration .....	84
12.5.8.	<b>SEMB:</b> Set measuring range .....	84
12.5.9.	<b>SARE:</b> Auto range on.....	85
12.5.10.	<b>SARA:</b> Auto range off .....	85
12.5.11.	<b>SREM:</b> Remote mode for AK-commands.....	85
12.5.12.	<b>SMAN:</b> Manual control to control device manually .....	85
12.5.13.	<b>SMGA:</b> Start measuring .....	85
12.5.14.	<b>SNKA:</b> Saves measured value as new offset.....	85
12.5.15.	<b>SEKA:</b> Saves measured value as new span value.....	85
12.5.16.	<b>SUDP:</b> Start /Stop UDP data streaming .....	85
12.6.	Settings .....	86
12.6.1.	<b>EKAK:</b> The four span gas concentration values are set.....	86

---

12.6.2.	<b>EMBE:</b> The four measuring range end values are set.....	86
12.6.3.	<b>EMBU:</b> The upper and the lower range switchover for auto range are set .	86
12.6.4.	<b>EKEN:</b> Set new device identification and information.....	86
12.6.5.	<b>EGRD:</b> Set polynom coefficients .....	86
12.6.6.	<b>EFDA:</b> Set autocalibration and purge times .....	86
12.6.7.	<b>EPAR:</b> Set autocalibration tolerance values .....	86
12.6.8.	<b>ESYZ:</b> Set System Time .....	87
12.6.9.	<b>ET90:</b> Set Lowpass Filter Time .....	87
12.6.10.	<b>EDAL:</b> Diagnostic alarm limits.....	87
12.6.11.	<b>ETCP:</b> Set TCP/IP Parameters .....	87
12.6.12.	<b>EH2O</b> Set H <sub>2</sub> O correction parameters.....	87
12.6.13.	<b>ECO2</b> Set CO <sub>2</sub> correction parameters.....	87
12.6.14.	<b>EUDP</b> Set UDP Data streaming parameters .....	88
12.6.15.	Format of the streaming Data via UDP:.....	88
12.7.	Abbreviations used .....	88
<b>13.</b>	<b>Appendix .....</b>	<b>89</b>
13.1.	Electrical Block Diagram.....	89

## Table of Figures

Figure 2-1 Single NDIR Analyzer .....	19
Figure 2-2 Detector Output Signal .....	20
Figure 2-3 Absorption Characteristic of Detector .....	20
Figure 2-4 Block Diagram .....	21
Figure 3-1 AC Power Switch, Connector, and Fuse.....	23
Figure 3-2 EMI Suppressor.....	<b>Error! Bookmark not defined.</b>
Figure 4-1 LCD Display.....	26
Figure 4-2 Keyboard .....	30
Figure 5-1 Main Menu on Power Up Screen .....	32
Figure 5-2 Main User Menu (Level 4).....	32
Figure 7-1 Main Menu Screen.....	34
Figure 7-2 Measurements Screen.....	34
Figure 7-3 Set to Auto Range (601).....	35
Figure 7-4 Analyzer set to Range 1 (603) .....	35
Figure 7-5 Main Menu (User Level 4).....	36
Figure 7-6 Purge Screen .....	36
Figure 7-7 Diagnostics Screen I.....	36
Figure 7-8 Calibration Screen .....	37
Figure 7-9 Auto Calibration Screen.....	37
Figure 7-10 Manual calibration.....	38
Figure 7-11 Manual zero calibration.....	38
Figure 7-12 Manual span calibration .....	38
Figure 7-13 Display deviations .....	39
Figure 7-14 Zero gas deviations .....	39
Figure 7-15 Span gas deviations .....	39
Figure 7-16 Setup menu screen I .....	41
Figure 7-17 setup menu screen II .....	41
Figure 7-18 Change Span Gas Settings .....	41
Figure 7-19 Change Auto Calibration Settings.....	42
Figure 7-20 Change Range Limits .....	42
Figure 7-21 Change Upper Range Limits.....	43
Figure 7-22 Change Auto Range Limits.....	43
Figure 7-23 Alarm screen I .....	44
Figure 7-24 Alarm screen II .....	44
Figure 7-25 Enter / Change Password.....	44
Figure 7-26 Access Level Screen .....	45
Figure 7-27 Linearization Screen .....	46
Figure 7-28 Coefficients Range Select .....	46
Figure 7-29 Change Coefficients .....	46

Figure 7-30 Linearized and raw data.....	46
Figure 7-31 System Setup Screen .....	47
Figure 7-32 Clock and Timing Setup Screen .....	47
Figure 7-33 Clock set screen .....	47
Figure 7-34 Set Auto Cal Timing.....	48
Figure 7-35 Set Auto Cal Ranges .....	48
Figure 7-36 F4 Toggles Auto Cal ON of OFF .....	48
Figure 7-37 TCP/IP Address.....	49
Figure 7-38 Output Assignments .....	49
Figure 7-39 Output Ranges .....	49
Figure 7-40 Status line.....	50
Figure 7-41 Status line on/off.....	50
Figure 7-42 Measure setup.....	50
Figure 7-43 Lowpass filter.....	50
Figure 7-44 Purge Time.....	51
Figure 7-45 T-compensation.....	51
Figure 7-46 P-Compensation.....	51
Figure 7-47 Low pass filter time constant .....	52
Figure 7-48 Analyzer Information.....	52
Figure 7-49 Software Version .....	52
Figure 7-50 F6 Remote/Manual .....	52
Figure 7-51 F7 Standby .....	53
Figure 7-52 Standby Mode .....	53
Figure 8-1 Internal components .....	58
Figure 8-2 Main Electronic Board Potentiometers.....	60
Figure 8-3 NDIR detector assembly.....	61
Figure 10-1 Optical Bench with Pipe Sample Cell.....	64
Figure 10-2 Optical Bench with Block Sample Cell .....	66
Figure 10-3 Optical Bench with Pipe and Block Type Sample Cells.....	68
Figure 11-1 Amplifier circuit ac wave form .....	75
Figure 12-1 Serial Interface .....	76

## Tables

Table 10-1 Optical Bench Configuration .....	63
Table 12-1 Structure of an instruction command .....	77
Table 12-2 Structure of an acknowledgement command .....	78
Table 12-3 Acknowledgment response in case of error .....	78

## 1. Introduction

### 1.1. Overview

Congratulations and thank you! You have just purchased one of the most reliable gas analyzers in the world. Before using the analyzer, please familiarize yourself with its operation by reading this manual. If you have any questions, please do not hesitate to call California Analytical Instruments for assistance. We want you to be a member of our thousands of satisfied customers.

### 1.2. Unpacking Instructions

Open the shipping container and carefully remove the analyzer from the packing materials. Inspect the instrument for any sign of damage. Remove the Top Cover retaining screws. Visually check for loose parts or connectors that are not properly seated. Verify all circuit boards and circuit board connections are secure. If all internal components look normal, re-install the cover.

### 1.3. Reporting Damage

Should there be any apparent damage either to the inside or outside of the instrument due to shipping or handling, immediately notify the shipper. The shipping container or packing materials should be retained for inspection by the shipper.

### 1.4. Contact Information

California Analytical Instruments, Inc.

1312 West Grove Avenue

Orange, CA 92865

714 974-5560

Fax 714 921-2531

Website: [www.gasanalyzers.com](http://www.gasanalyzers.com)

**1.5. Warranty Certificate**

Subject to the exceptions and upon the conditions stated below, California Analytical Instruments (CAI) warrants that the products sold under this sales order shall be free from defects in workmanship and materials for one year after delivery of the product to the original Buyer by CAI and if any such product should prove to be defective within such one year period, CAI agrees, at its option, either (i) to correct by repair or, at CAI's election, by replacement with equivalent product any such defective product, provided that investigation and factory inspection discloses that such defect developed under normal and proper uses, or (ii) to refund the purchase price. The exceptions and conditions mentioned above are as follows:

- a. components or accessories manufactured by CAI that by their nature are not intended to or will not function for one year are warranted only to give reasonable service for a reasonable time. What constitutes reasonable time and reasonable services shall be determined solely by CAI. A complete list of such components and accessories is maintained at the factory;
- b. CAI makes no warranty with respect to components or accessories not manufactured by it; in the event of defect in any such component or accessory CAI will give reasonable assistance to Buyer in obtaining from the respective manufacturer whatever adjustment is authorized by the manufacturer's warranty;
- c. any product claimed to be defective must be returned to the factory transportation charges prepaid and CAI will return the repaired or replaced product freight collect;
- d. if the product claimed to be defective requires on-site repair, such warranty labor will be provided at no charge; however, transportation and living expenses will be charged to Buyer;
- e. if the product is a consumable or the like, it is warranted only to conform to the quantity and content and for the period (but not in excess of one year) stated on the label at the time of delivery or 90 days;
- f. CAI may from time to time provide a special printed warranty with respect to a certain product, and where applicable, such warranty shall be deemed incorporated herein by reference;
- g. CAI shall be released from all obligations under all warranties, either expressed or implied, if any product covered hereby is repaired or modified by persons other than its own authorized service personnel unless such repair by others is made with the written consent of CAI.

IT IS EXPRESSLY AGREED THAT THE ABOVE WARRANTY SHALL BE IN LIEU OF ALL WARRANTIES OF FITNESS AND OF THE WARRANTY OF MERCHANTABILITY AND THAT CAI SHALL HAVE NO LIABILITY FOR SPECIAL OR CONSEQUENTIAL DAMAGES OF ANY KIND OR FROM ANY CAUSE WHATSOEVER ARISING OUT OF THE MANUFACTURE USE, SALE, HANDLING, REPAIR, MAINTENANCE OR REPLACEMENT OF ANY OF THE PRODUCTS SOLD UNDER THIS SALES ORDER. SOME STATES DO NOT ALLOW THE EXCLUSION OR LIMITATION OF INCIDENTAL OR CONSEQUENTIAL DAMAGES, SO THAT THE ABOVE LIMITATIONS OR EXCLUSIONS MAY NOT APPLY. THIS WARRANTY GIVES YOU SPECIFIC LEGAL RIGHTS, AND YOU MAY HAVE OTHER RIGHTS, WHICH VARY FROM STATE TO STATE.

Representations and warranties made by any person, including dealers and representatives of CAI which are inconsistent or in conflict with the terms of this warranty, shall not be binding upon CAI unless produced in writing and approved by an expressly authorized officer of CAI.



**1.6. Proper Operation**

Personnel should be trained in the proper operation of this equipment before attempting to operate the equipment.

**1.7. Possible Explosion Hazard**

Do not apply power to the analyzer or attempt to energize the analyzer until determining the analyzer environment to be non-hazardous.

Use this analyzer in a **NON-HAZARDOUS** environment.

This analyzer has not been designed for use with a hazardous sample.

Tampering or use of substitute components may cause a safety hazard. Use only factory authorized replacement parts.

**1.8. Electrical Shock Hazard**

Disconnect power before removing cover. Servicing requires access to live electrical components that can cause death or serious injury. Refer servicing to qualified service personnel. For safety and proper performance, connect this instrument to a properly grounded three-wire receptacle.

**Caution****1.9. Plug Removal**

***Do not operate this analyzer UNTIL REMOVING the red plastic ¼ inch plugs from the sample inlet and exhaust fittings on the rear panel.***



**Use of this equipment in a manner not approved by California Analytical Instruments is not recommended and may cause harm to the equipment or operating personnel.**

## 2. Features

### 2.1. Description

The Model 600 series of NDIR analyzers incorporate a single-beam photometric system and a detector with a microflow sensor assuring high reliability, sensitivity, accuracy, and stability. The microflow detector is a sealed unit filled with the same gas as the component of interest (CO, CO<sub>2</sub>, and CH<sub>4</sub>). The length of the sample cell determines the most sensitive range for each component.

### 2.2. Features-General

The Model 600 series of NDIR analyzers have a 3 by 5 inch liquid crystal display and a 20 key data/operation input keyboard. The 16-bit microprocessor control board consists of the MSR-Card with 16 digital inputs, 16 digital outputs, 16 analog inputs and 4 analog outputs. The analyzer can be manually operated from the keypad or remotely via TCP/IP or RS-232C communications. After turning on the analyzer, it needs at least 30 seconds for initialization. During this time, the screen is illuminated.

**IMPORTANT TIP:** *When the analyzer is powered up, it defaults to access level 1 (User). To operate ALL parameters, check the access level. See Section 5.*

### 2.3. Features-General

High stability is provided by an improved photometric system, which assures less influence due to contamination of the measuring cell and higher long-term stability than conventional dual-beam analyzers.

- A dual-chamber type detector effectively minimizes influence due to concomitant gas components.
- A microflow sensor within the detector features high reliability, long service life, very low noise, and excellent resistance to vibration.
- The easily serviced single-beam photometric system does not require delicate adjustment of the optical-balance.
- Simple construction assures reliable performance.
- Modular component design simplifies maintenance. Independent elements are easily removed for maintenance.
- Low Power Consumption - The instruments are of energy-saving design with power consumption as low as 30 VA.

### 2.4. Infrared Gas Analyzers

The infrared gas analyzer measures gas concentration based on the principle that each type of gas component shows a unique absorption line spectrum in the infrared region.

The instrument consists of an infrared light source, a chopper, a measuring cell, and a detector filled with a gas mixture containing the gas component to be measured. The operating principle of the instrument is described with reference to Figure 2-1. The infrared light source emits infrared light in all directions. The light emitted forward is transmitted and reflected into the detectors.

The infrared light emitted backward is reflected by a reflecting surface and is added to the infrared light emitted forward. Arranged between the infrared light source and measuring cell is a chopper blade which rotates to modulate the infrared light beam at regular frequency. The modulated infrared light beam thus formed passes through the measuring cell filled with a sample gas where the light energy is partially absorbed or attenuated before it reaches the front chamber of the detector. Both the front and rear chambers of the detector are filled with the gas component to be measured.

The infrared light energy is partially absorbed in the front chamber and residual light is absorbed in the rear chamber, thereby increasing pressure in both chambers. Since the detector is designed to produce a pressure difference between the front and rear chambers, a slight gas flow is produced through a path connecting these chambers with each other.

This slight flow is converted into an AC electrical signal by a microflow sensor arranged in the path connecting the chambers with each other. The AC signal is amplified and rectified to a DC voltage supplied to the output terminals and indicator (Figure 2-4). Figure 2-2 shows the detector output signal with the greatest amplitude when zero gas is flowing in the measuring cell. Amplitude is reduced as the concentration of measured gas component increases (Figure 2-3)

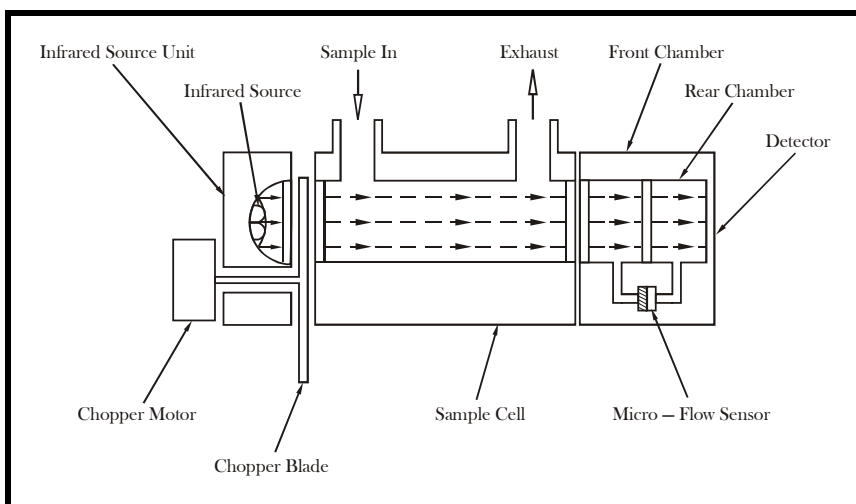

Figure 2-1 Single NDIR Analyzer

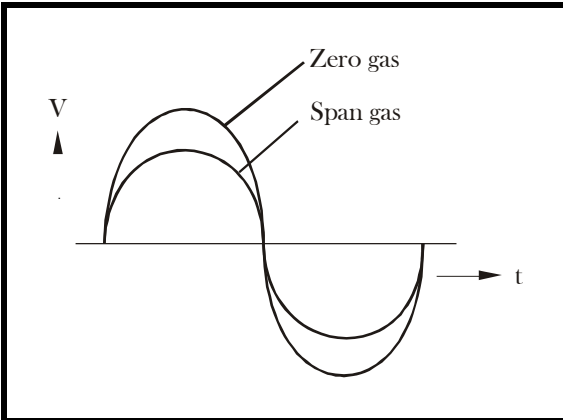

Figure 2-2 Detector Output Signal

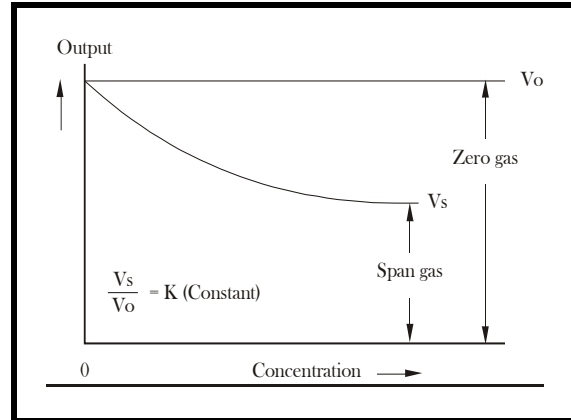

Figure 2-3 Absorption Characteristic of Detector

### 2.5. Interference Gases

Whenever a sample gas contains a gas component that has an absorption spectrum that overlaps the spectrum of the gas to be measured, that gas is commonly referred to as an interference gas. The Microflow Detector was specifically designed to minimize the effect of interference gases. When these gases are present, the pressure rises in the front and rear chamber of the detector cancel each other minimizing any response to the interference gases.

### 2.6. Electronics

The sinusoidal output signal of the detector's microflow sensor is transmitted to the AC amplifiers on the main circuit board. The signal frequency is related to the rate of the beam-interrupting chopper blade. The signal amplitude is related to the measured gas concentrations in the sample cell.

This signal is amplified by successive AC amplifiers and then demodulated and filtered. The resulting DC signal is further amplified and fed into two output buffer amplifiers. The DC signal output of the printed circuit board is the input to a microprocessor. Here it is digitized and linearized for digital display

The digitized information is then fed to a D/A Converter so it can be isolated and converted to a 0-10 VDC or 4-20 mA output. This output (along with optional alarm contacts) is sent to the 28-pin output connector located on the rear panel of the analyzer for customer connection.

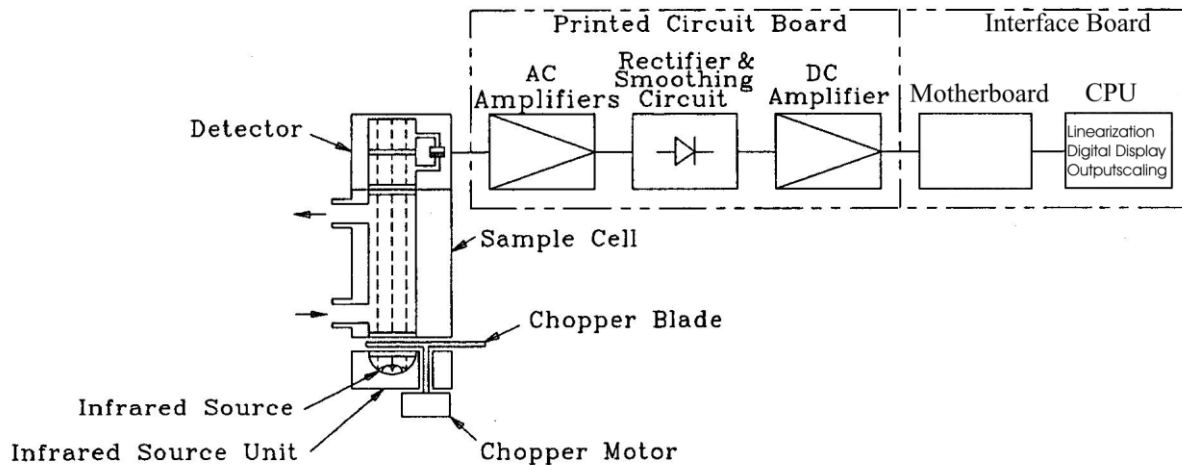

Figure 2-4 Block Diagram

**2.7. Model 600 NDIR Specifications**

<b>IR ANALYSIS METHOD</b>	Non-Dispersive Infrared (NDIR)
<b>NDIR COMPONENTS</b>	CO /CO <sub>2</sub> / CH <sub>4</sub> / C <sub>3</sub> H <sub>8</sub> /SO <sub>2</sub>
<b>DETECTOR TYPE</b>	Microflow
<b>RANGE RATIO</b>	10:1
<b>RESPONSE TIME (IR)</b>	T90 < 2 Seconds to 60 Seconds Adjustable (Depending on configuration)
<b>IR SAMPLE CELL</b>	Stainless Steel with Replaceable Gold Cell Liner
<b>RESOLUTION</b>	Displays Five Significant Digits
<b>REPEATABILITY</b>	Better than 1.0% of Full Scale
<b>LINEARITY</b>	Better than 0.5% of Full Scale of Factory Calibrated Ranges
<b>NOISE</b>	Less than 1% of Full Scale of Factory Calibrated Ranges
<b>ZERO &amp; SPAN DRIFT</b>	Less than 1% of Full Scale per 24 Hours
<b>ZERO &amp; SPAN ADJUSTMENT</b>	Via front panel, TCP/IP or RS-232
<b>SAMPLE FLOW RATE</b>	0.25 to 2.0 Liters/minute (LPM) (Consult Factory for other flow rates)
<b>OXYGEN ANALYSIS METHOD</b>	Paramagnetic
<b>O<sub>2</sub> RANGES</b>	0 — 1% up to 0 – 100% O <sub>2</sub> Full Scale, Four Definable Ranges
<b>O<sub>2</sub> RESPONSE TIME</b>	90 < 2 Seconds

**2.8. Model 600 NDIR Features**

<b>OUTPUTS AVAILABLE</b>	TCP/IP, RS232, Four Scalable Analog 0-10 V / 4-20 mA (Allows Offset and Expandable Range DC Analog Outputs)	
<b>DISCRETE CONTROL</b>	Remote/Local Control, Range Change, Range Sense Mode (AI TTL Logic)	
<b>DISCRETE ALARMS (Local &amp; Remote Adjustable)</b>	General Fault/ TTL Logic 0-5 VDC (Ground True) Calibration Failure/ TTL Logic 0-5 VDC (Ground True) High Concentration (2 each)/ TTL 0-5 VDC Logic (Ground True)	
<b>KEYPAD DISPLAYS</b>	Factory Settings TCP/IP Address Passwords (4)	Scalable Analog Output Voltages Full Scale Range Select Auto Cal Times
<b>SPECIAL FEATURES</b>	Auto Ranging Auto Calibration (adjustable through internal clock)	
<b>DISPLAY</b>	3" x 5" Back lit LCD	
<b>SAMPLE TEMPERATURE</b>	Up to 50°C Non-condensing	
<b>AMBIENT TEMPERATURE</b>	5 to 40°C	
<b>AMBIENT HUMIDITY</b>	Less than 90% RH Non-condensing	
<b>WARM-UP TIME</b>	1 Hour (Typical)	
<b>FITTINGS</b>	1/4 Inch Tube	
<b>POWER REQUIREMENTS</b>	115 V 60Hz (Option: 230V 50Hz), Less than 1 amp	
<b>DIMENSIONS</b>	5¼ H x 19 W x 23 D (Inches)	
<b>WEIGHT</b>	30-45 Pounds (Depending on configuration)	

**SPECIFICATIONS ARE SUBJECT TO CHANGE WITHOUT NOTICE**

### 3. Installation

#### 3.1. General

The design of this instrument is for industrial applications. These installation instructions are for a typical site. Direct any questions regarding specific installation situations to Technical Service of California Analytical Instruments, Inc.

#### 3.2. Site and Mounting

**NOTE: The carefully observe the following precautions:**

Select a site free from direct sunlight, radiation from a high temperature surface, or abrupt temperature variations.

This analyzer is not suitable for installation outdoors.

Select a site where the air is clean. Avoid exposing the instrument to corrosive or combustible gases.

The instrument must not be subject to severe vibration. If severe vibration is present, use isolation mounts.

The instrument is designed for rack-mounting. Optional rack mount slides are available.

Do not install near equipment emitting electromagnetic interference (EMI).

**NOTE: A rear supporting brace or equivalent is required if the optional rack mount slides were not purchased.**



**The power on/off switch is accessible from the rear of the instrument only. DO NOT mount such that the power on/off switch is inaccessible.**

#### 3.3. Electrical

All wiring is connected at the rear of the instrument. The AC power is connected to the power/fuse/switch as shown below

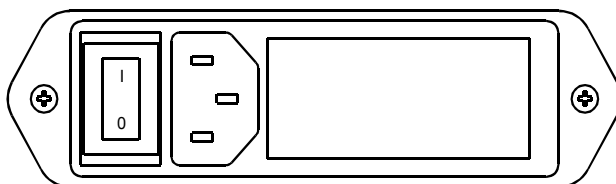

**Figure 3-1 AC Power Switch, Connector, and Fuse.**

**NOTE:** A defective ground may affect the operation of the instrument. The output voltages are connected per Table 8.1.1. Shielded wiring is recommended for output signals.



**Replace fuses with recommended fuse size indicated on rear panel of instrument. Replacement with any other size fuse may cause damage to the instrument and possible injury to operating personnel.**

#### **3.4. Analog Output Connections (Appendix)**

See Appendix for connector pinouts located on the analyzer rear panel. Remote range identification and range selection are obtained via the rear panel connections. When a range is selected, the corresponding control line is pulled low to zero VDC. Ranges not selected will remain at approximately 5 VDC. When remote range control is selected on the front panel switch, a contact closure is provided at the rear panel connector. Remote range selection is made by connection of the control line for the desired range to the analyzers zero VDC line provided in the connector. Five VDC is also provided.

#### **3.5. Gases**

- 1) Nitrogen or (zero air) in pressurized cylinder.
- 2) Standard span gas(es) near full-scale concentration with a nitrogen balance, in a pressurized, certified cylinder.



### 3.6. Gas Handling Equipment

- 1) Pressure regulators for zero gas (Air or N<sub>2</sub>), and span gas cylinders.
- 2) Corrosive resistant gas tubing.

### 3.7. Gas Connections

The tubing from the sampling system to the gas analyzer should be made from corrosive-resistant material such as Teflon or stainless steel. Even when the gases being sampled are corrosive themselves, rubber, or soft vinyl tubing should not be used since readings may be inaccurate due to gas absorption into the piping material. To obtain fast response, the tube should be as short as possible. Optimum tube internal diameter is 0.16 inch (4 mm). Couplings to the instrument are ¼-Inch tube.

**Note: Be sure tubing and joints are clean. Dust entering the instrument may cause it to malfunction.**

### 3.8. Sampling Requirements

#### 3.8.1. Filtration

Dust must be eliminated completely. Use filters as necessary. The final filter must be capable of removing particles larger than 4 microns.

#### 3.8.2. Condensation

Dew point of the sample gases must be lower than the instrument temperature to prevent accidental condensation within the instrument. Bypass the sample through a dehumidifier to reduce the dew point to about 2 to 4° C or less. If the sample contains an acid mist, use an acid mist filter, cooler or similar device to remove all traces of the mist.

#### 3.8.3. Presence of Corrosive Gases

High concentrations of corrosive gases such as Cl<sub>2</sub>, SO<sub>2</sub>, F<sub>2</sub>, HCl, in the sample gas shorten the useful service life of the instrument.

#### 3.8.4. Gas Temperature

Do not exceed the maximum rating of the instrument 104° F (50° C) when measuring high temperature gases.

#### 3.8.5. Sample Gas Bypass Outlet (Vent)

A sample gas bypass outlet connector is located on the rear panel (¼ Inch Tube). Pressure at this outlet should be kept at atmospheric level. **ANY** backpressure will cause an error in reading.

## 4. Basic Operation

The operation of the digital microprocessor conforms to the guidelines of the AK committee, originally developed in the German automotive industry. Via the serial port of the MSR-Card, the analyzer can be remote-controlled by a master computer. The serial communication fully corresponds to the specifications of the AK protocol. TCP/IP communication is also available.

### Display

The analyzer's LCD display includes 16 lines with 30 characters each. The display also has background lighting that can be switched on and off via the Display key on the keyboard. The following example shows the measurement screen that is formatted into 4 information areas.

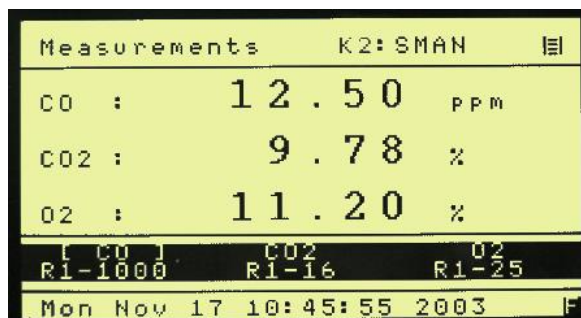
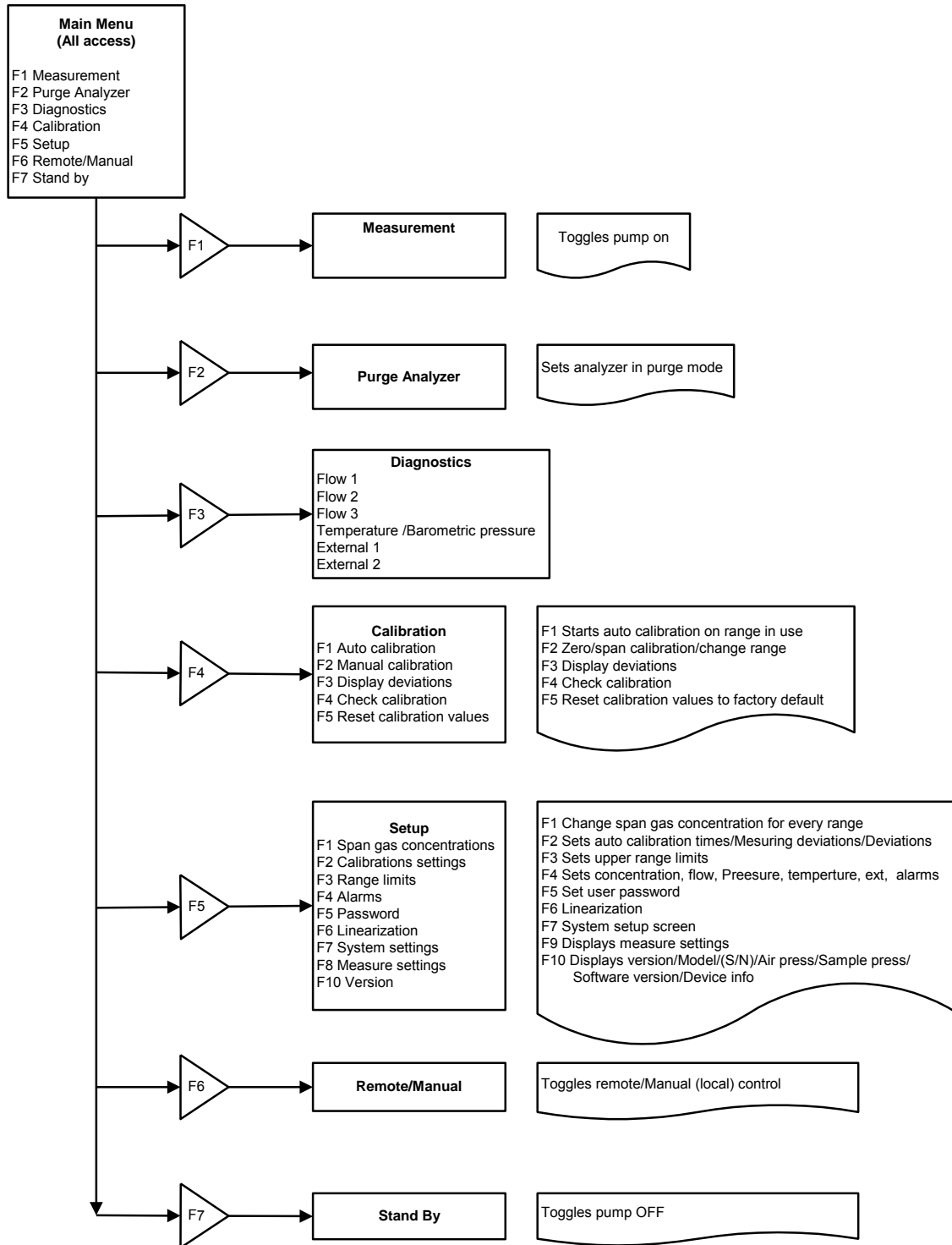

**Figure 4-1 LCD Display**

- 1) THE TOP INFORMATION AREA CONTAINS:
- 2) The AK Protocol Information. This capability is for advanced uses and may be toggled on and off in the setup screen, F5. Next to the symbol for the active operating mode, the device status is indicated. The status field is also displayed on all other screens.
- 3) SARE Auto range enabled
- 4) SMGA Measuring gas is flowing
- 5) SMAN Device is in manual operation status
- 6) SWET Device
- 7) Shown on the right is the Password Entry level with 1 to 4 horizontal lines.
- 8) THE LARGE INFORMATION AREA CONTAINS the data portion of the screen.
- 9) THE THIRD INFORMATION AREA CONTAINS the help information for the parameter selected, ranges, etc.
- 10) THE LOWER INFORMATION AREA CONTAINS The time and date and any error condition.
- 11) The symbol in the bottom right corner indicates the keyboard mode. In the example shown, the keyboard is in the function key mode. For input fields, the mode is usually switched to numerical input. Then, an N appears in the lower right of the screen. This symbol is displayed on all screens.

4.1. Menu Trees

Model 601 Menu Tree



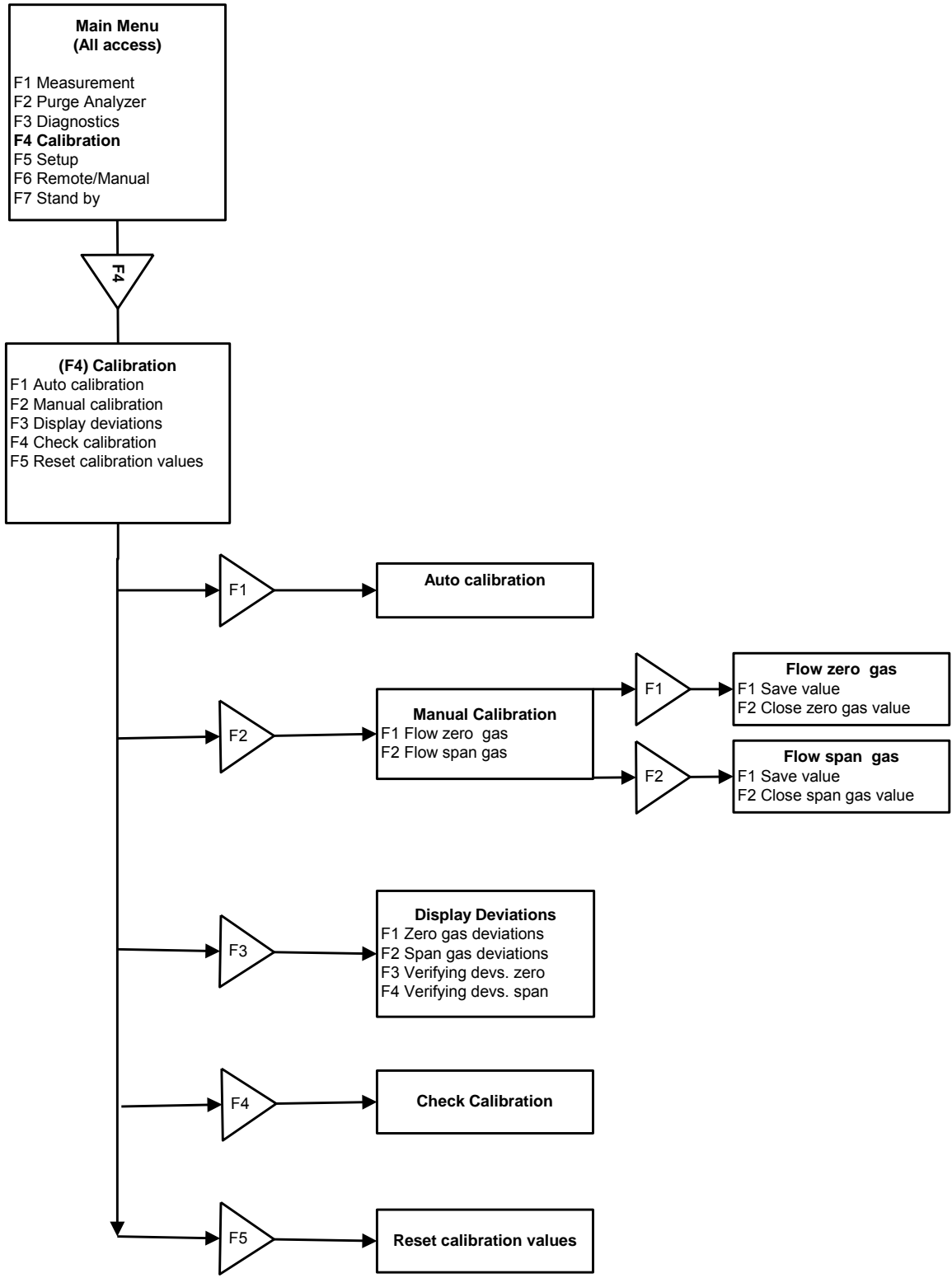

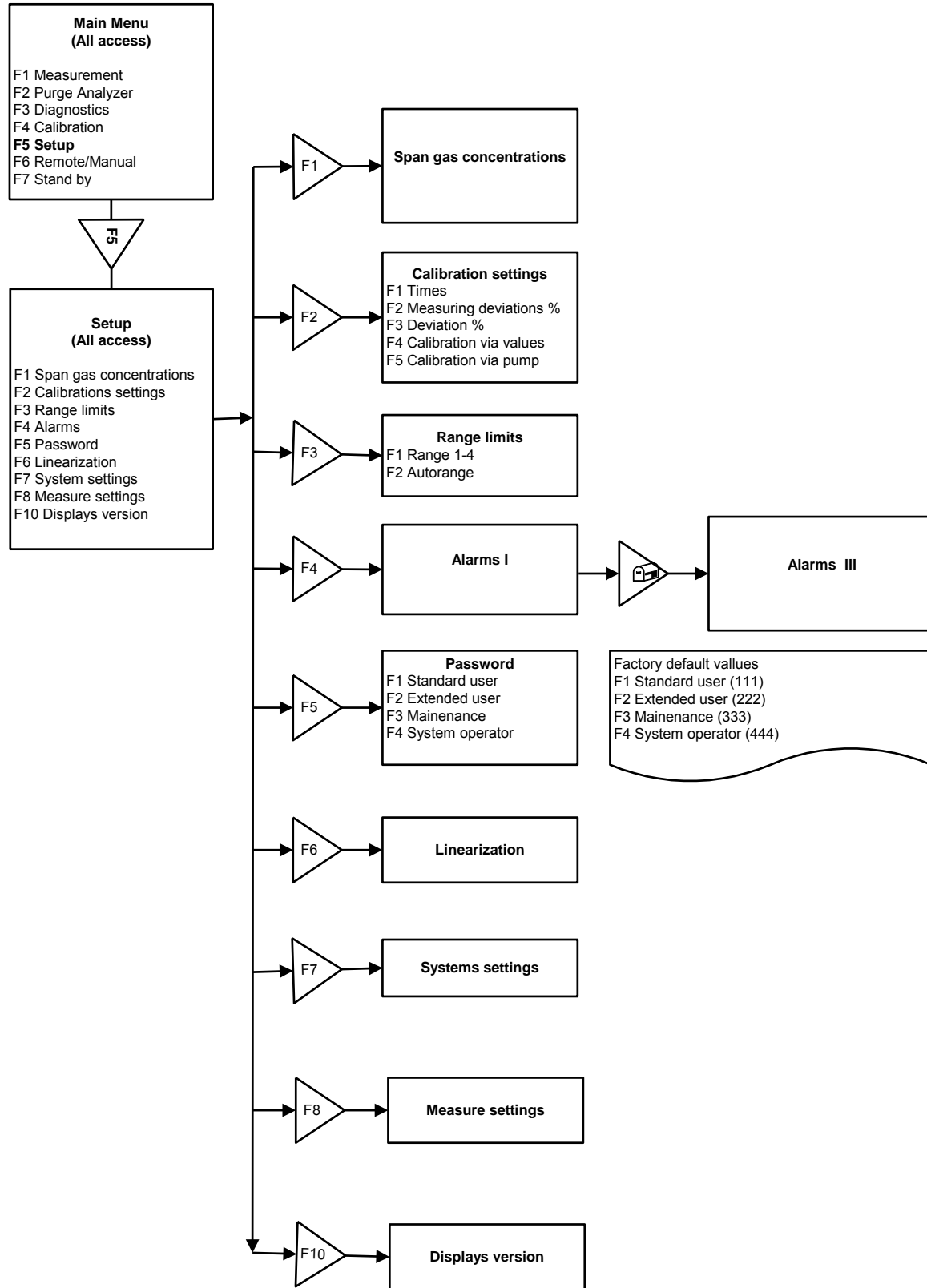

## 4.2. Keyboard

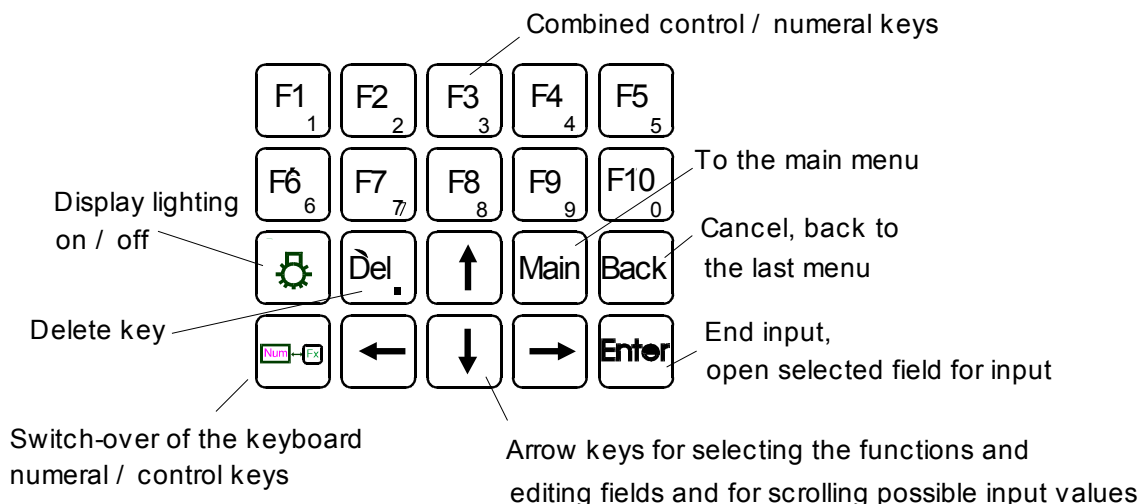

**Figure 4-2 Keyboard**

### 4.2.1. Operation with the Cursor Keys and the Enter Key

When operating the unit with the cursor keys, you select the various functions with the up/down cursor keys and start them with the Enter key. This method is particularly suitable for less proficient users since the system displays a short on-line help for nearly every function selected. The actual cursor position is shown as a black horizontal bar.

**TIP: If you are not yet familiar with the screens and their fields, just press any cursor key after a screen appears. This moves the cursor from field to field and displays the corresponding online help.**

### 4.2.2. Operation with the Function Keys

When using the function keys (F1 through F10), functions are directly accessed by pressing their corresponding function keys. This method is suitable for the advanced user since it is faster than the operation with the cursor keys.

### 4.2.3. Read/Change Parameters

To read and/or change parameters, you must switch to the parameter input mode by pressing the Enter key after calling the corresponding parameter screen. The input cursor (horizontal bar under the first character) then appears in the active edit field (black background). The cursor can be positioned with the right and left cursor keys, and the value displayed (number or letter) can be changed with the up and down cursor keys or entered directly. Every input has to be concluded by pressing the Enter key again, which causes the cursor to disappear.

## 5. Operating Structure

The analyzer's operation can be divided into 4 operating levels. The current level is always displayed as a stack of 1 to 4 horizontal bars in the top right corner of the screen. In the access level menu, you can choose between the following operating levels:

F1	User	(operating level 1)
F2	Advanced user	(operating level 2)
F3	Maintenance	(operating level 3)
F4	System user	(operating level 4)

A password can be assigned to each operating level. Only the system user, who normally has the highest operating priority, can assign the password. At the factory, the default passwords for the CAI analyzers are set as follows:

User:	111
Advanced user:	222
Maintenance:	333
System:	444

The default setting can be changed only by the system user. This manual is written to include all information for the advanced system user.

***TIP: Because of the user settings, some of the parameters shown in this manual may not appear on your analyzer. Check the access level.***

### 5.1. The Main Menu

Upon power up, the CAI logo is first displayed and then the main menu appears as below:

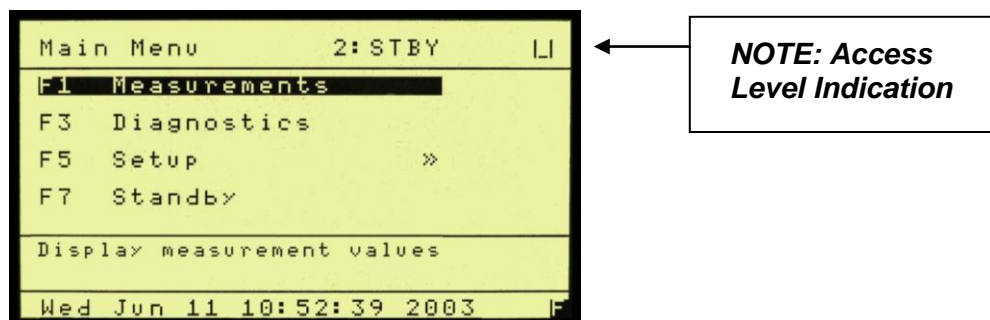

Figure 5-1 Main Menu on Power Up Screen

**NOTE:** F6 is not available because, on initial start up, the analyzer reverts to ONLY Level 1 access. See Section 7.5.5 for Password information.

All functions can be selected with the cursor keys and activated by pressing the Enter key, or directly with the function keys F1 through F7. A ">" to the right of a function means that one or more sub-menus are available. If this sign is missing, the function starts immediately after the activation.

**NOTE:** Access level is 4.

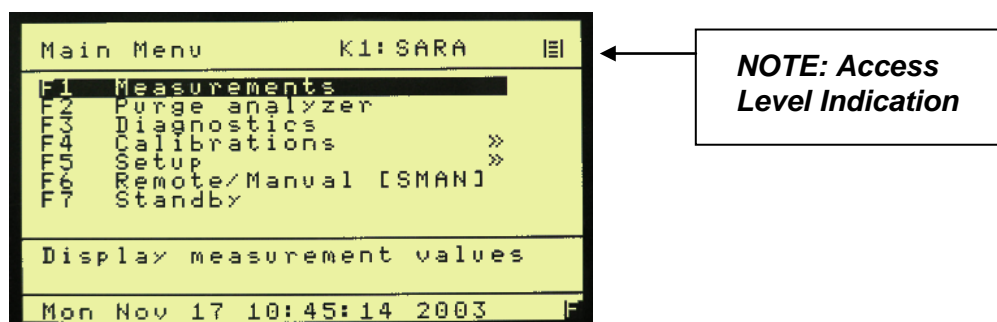

Figure 5-2 Main User Menu (Level 4)



## 6. Menu Structure

There are four operating levels based on the level of your password. This section shows the access rights of the single levels.

### 6.1. User Functions (Level 1)

Main Menu		Setup Menu		Password Menu	
F1	Measurements	F5	Password	F1	Enter password
F2	Purge Analyzer	F10	Version		
F3	Diagnostics				
F4	Calibrations				
F5	Setup				
F7	Standby				

### 6.2. Advanced User Functions (Level 2)

Main Menu		Setup Menu		Password Menu	
F1	Measurements	F3	Range Limits	F1	Enter password
F2	Purge Analyzer	F5	Password		
F3	Diagnostics	F10	Version		
F4	Calibrations				
F5	Setup				
F7	Standby				

### 6.3. Maintenance Functions (Level 3)

Main Menu		Setup Menu		Password Menu		System Settings Menu	
F1	Measurements	F1	Span Gas Concentration	F1	Enter password	F1	Real Time Clock
F2	Purge Analyzer	F3	Range limits	F2	Reset password	F5	Status Line on/off
F3	Diagnostics	F5	Password	F7	Auto Startup		
F4	Calibrations	F7	System Settings				
F5	Setup	F8	Measure Settings				
F7	Standby	F10	Version				

### 6.4. System User Functions (Level 4)

All Function described in this manual may be accessed from Level 4.

## 7. Main Menu Function Descriptions

### 7.1. F1 Measurements

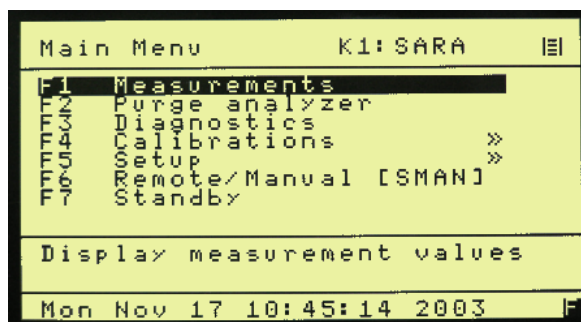

Figure 7-1 Main Menu Screen

#### 7.1.1. F1 Measurement

The measurements screen is activated by pressing F1 on the Main Menu screen. The concentration is displayed in actual engineering units.

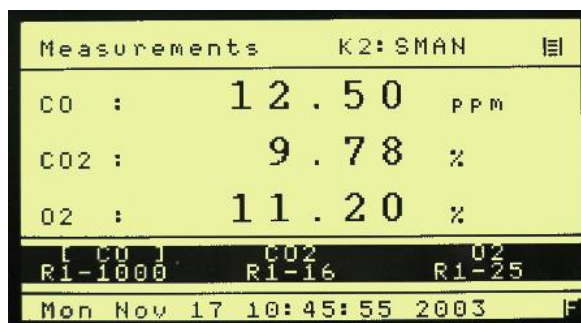

Figure 7-2 Measurements Screen

## 7.1.2. Range Select

With the arrow keys, the ranges 1 to 4 can be selected and locked in which will disable the auto range capability. Continue pressing the arrow keys will recycle the analyzer back to auto range. The range and/or auto range is displayed on the measurement screen. If the limits are exceeded while not in the auto range mode, a warning "Over Range" appears on the screen.

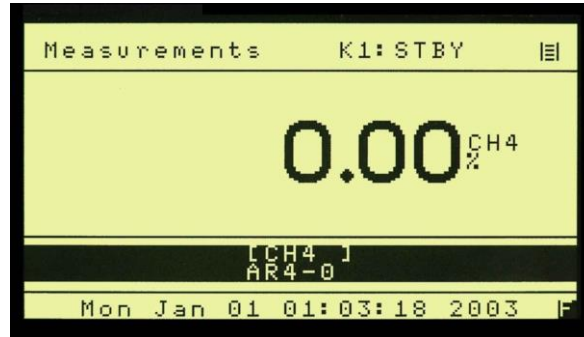

Figure 7-3 Set to Auto Range (601)

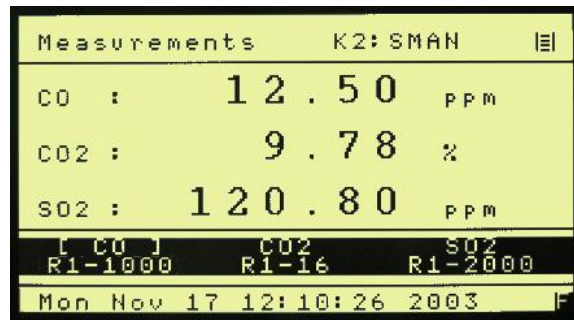

Figure 7-4 Analyzer set to Range 1 (603)

### 7.2. F2 Purge Analyzer

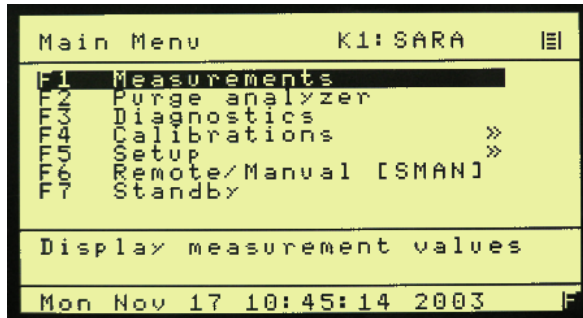

Figure 7-5 Main Menu (User Level 4)

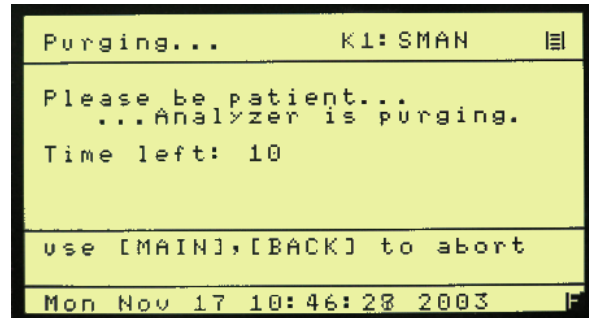

Figure 7-6 Purge Screen

F2 from the Main Menu activates the Purge (analyzer) function if equipped.

### 7.3. F3 Diagnostics

F3 from the Main Menu activates the Diagnostics function. F3 brings up the two diagnostics screens. The Diagnostics screens may be brought up from **EITHER** the Main Menu or the Measurements screen.

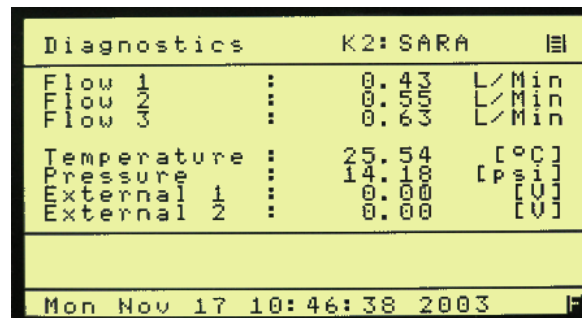

Figure 7-7 Diagnostics Screen I

#### 7.4. F4 Calibrations

F4 from the Main Menu activates the Calibrations screen. Calibrations may be automatic or manual. Deviations can also be displayed. Calibration values can be reset to default values and the range to be calibrated can be changed.

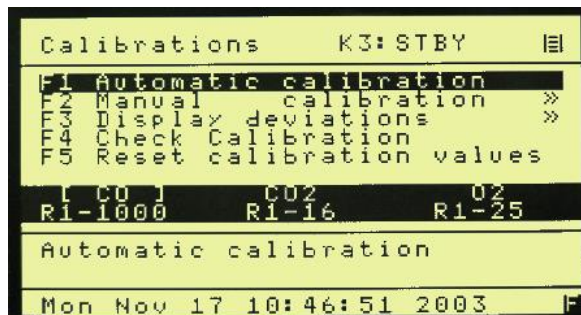

Figure 7-8 Calibration Screen

##### 7.4.1. F1 Automatic Calibration

From the Calibrations screen, F1 starts automatic calibration. If auto range is selected, the actual range in use will be calibrated. Auto calibration works as follows: First, zero gas is purged a certain time, called purge-time. Then the measurement begins. The measured value must be a minimum-time, called measuring-time, and within an upper and a lower limit to be saved as new offset value. The maximum length of measuring time is 9 seconds. If the measured value was constant during calibration time, it is checked to determine if this value deviates from the preceding value. If the deviations are too large, a warning "Deviation error!" appears and the user can choose if the new value is saved or not. At last, the zero gas is flowed a further time, verifying time, so it can be checked if the signal is still constant. All of these times can be changed. After zero gas calibration, the same happens with span gas. During auto calibration, "Calibration in progress" is displayed. It also shows which gas is flowing and which time runs. When auto calibration has finished it is displayed. If the span value of the selected range is 0 (see section 5.6.1), then it will not be calibrated. If one range is calibrated and the span value for the lower ranges is zero, calibration parameters will be copied to this range. To calibrate all ranges with the same span gas, you must enter the gas concentration in the Span Gas Calibration screen for ALL RANGES. You must also calibrate each range. Offsets and scalors are NOT copied to other ranges.

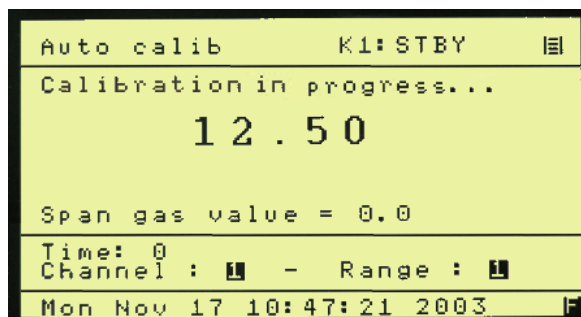
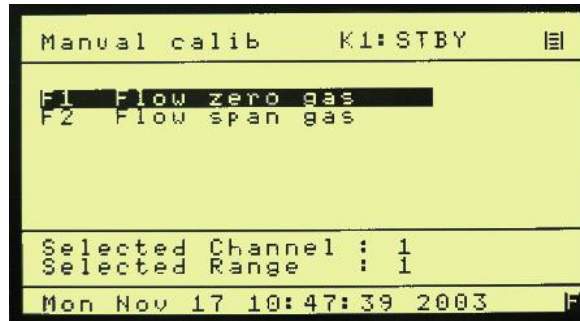

Figure 7-9 Auto Calibration Screen

## 7.4.2. F2 Manual Calibration

From the Calibration screen, F2 starts manual calibration. If auto range is selected, calibration is not possible, and the appropriate range can be selected.

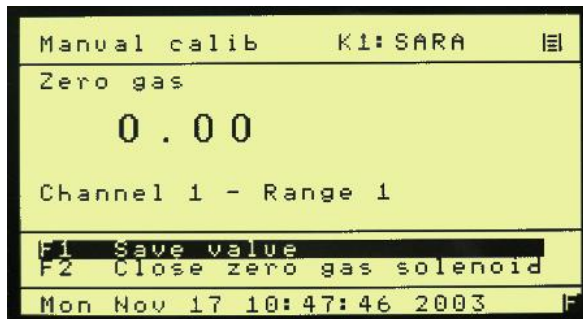

**Figure 7-10 Manual calibration**

In the manual calibrations menu, two options are possible:

F1 Flow zero gas

F2 Flow span gas



**Figure 7-11 Manual zero calibration**

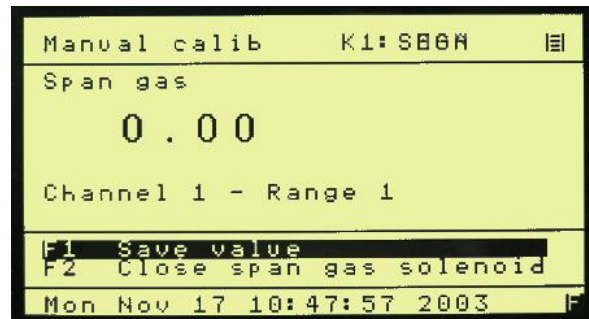

**Figure 7-12 Manual span calibration**

When zero or span gas is flowing, the measured value can be saved by pressing F1. If the screen is left by pressing the buttons "Main" or "Back", the measured value is not saved. Solenoids are closed by pressing F2.

#### 7.4.3. Display Deviations – from Calibration menu F3

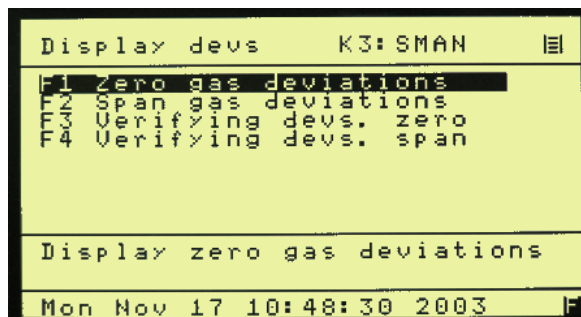

**Figure 7-13 Display deviations**

After every calibration, the deviations are calculated for zero and for span gas.

F1 Zero gas deviations

F2 Span gas deviations

F3 Deviations of zero gas during verifying

F4 Deviations of span gas during verifying

F1 and F2 deviations are displayed in percent.

	abs	rel
Range1:	0.00	0.00
Range2:	0.00	0.00
Range3:	0.00	0.00
Range4:	0.00	0.00

**Figure 7-14 Zero gas deviations**

	abs	rel
Range1:	0.00	0.00
Range2:	0.00	0.00
Range3:	0.00	0.00
Range4:	0.00	0.00

**Figure 7-15 Span gas deviations**

During calibration, there is verification for zero and span gas. With option F3 and F4, you can view the deviations during the verification time. Absolute deviation is the absolute average difference from the saved value in ppm. Relative deviation is the absolute average difference in percent, related to the range limit.

#### 7.4.4. Absolute Zero Gas Deviation

Absolute zero gas deviation is zero gas content calculated by the factory polynomial related to the range limit of the calibrated range.

#### 7.4.5. Relative Zero Gas Deviation

Relative zero gas deviation is the actual deviation minus the deviation of the previous calibration related to the range limit of the calibrated range.

#### 7.4.6. Absolute Span Gas Deviation

Absolute span gas deviation is span gas bottle value minus span gas value calculated by the factory-polynomial related to the range limit of the calibrated range.

#### 7.4.7. Relative Span Gas Deviation

Relative span gas deviation is the actual deviation minus the deviation of the previous calibration related to the range limit of the calibrated range.

#### 7.4.8. F4 Check Calibration

There is a default calibration. Pressing F4 activates an automatic zero and span check for verification.

#### 7.4.9. F5 Reset Calibration Values

There is a default calibration. Pressing F5, a new screen appears and asks if the user is sure to reset calibration values to the default calibration values. F1 confirms and the calibration values are reset to default calibration values. F2 leaves this menu without resetting to default values. This function will overwrite all calibrations with factory values. In addition, the linearization polynomial will be overwritten with the factory values.

#### 7.4.10. F6 Range Select

This allows a range change to be activated from the calibration menu.



### 7.5. F5 Setup

From the Main Menu, F5 brings up the setup menu. Span gas concentrations, calibration settings, range limits, alarms, password, linearization, system and measure settings can be changed. The Setup menu begins as shown below. A description of each parameter is shown in the information box. NOTE: Use the down arrow key to obtain the additional setup parameters.

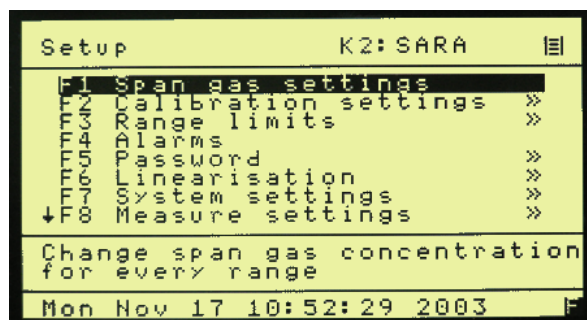

Figure 7-16 Setup menu screen I

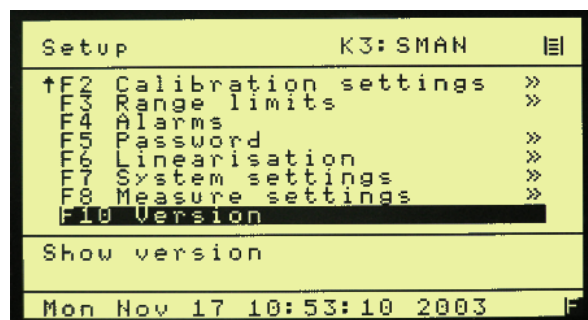

Figure 7-17 setup menu screen II

#### 7.5.1. F1 Span Gas Concentration

**Note: If you do not have a specific gas for a specific range, the calibration will use the previous ranges calibration. You must have a least one span gas.**

For calibration, it is necessary to input the concentration of the span gas in ppm. For every range, the span gas concentration can be changed. After pressing F1 in the setup menu, a screen appears in which changes can be made. Select with the cursor buttons the range to change. The selected field turns black. To change parameters, switch to parameter input mode by pressing the Enter key. The input cursor (horizontal bar under the first character) then appears in the active edit field (black background). The cursor can be positioned with the right and left cursor keys, and the value displayed (number or letter) can be changed with the up and down cursor keys or entered directly. Every input has to be concluded by pressing the Enter key again. Then the input cursor disappears and a new range can be selected. The changes are saved by leaving the screen by pressing "Main" or "Back." At the right side of the screen, the range limits of the 4 ranges are displayed. They cannot be changed in this screen.

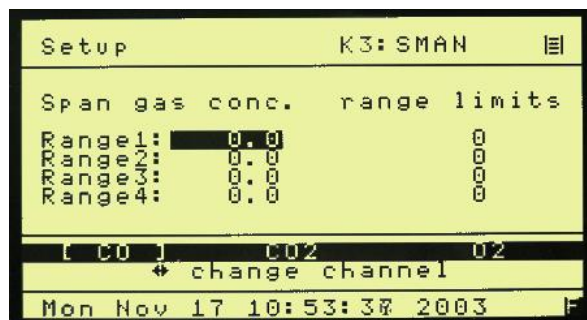
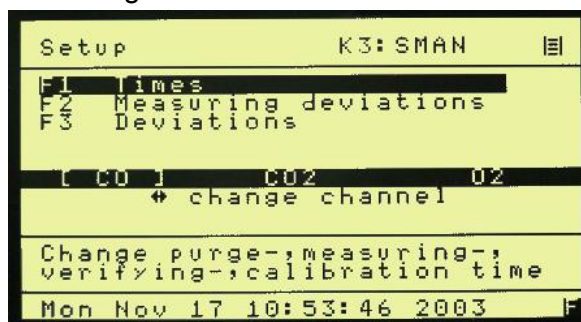

Figure 7-18 Change Span Gas Settings

## 7.5.2. Calibration Settings



**Figure 7-19 Change Auto Calibration Settings**

In the calibration settings menu, times and, deviations can be changed.

## 7.5.3. F1 Times

There are four times (in seconds) for auto calibration that can be changed. Purge, measuring, calibration and verifying time. Changes are made and saved as above.

## 7.5.4. F2 Measuring Deviations

During auto calibration, the measured value is only saved if it is within a certain time within an upper and a lower limit. These two limits format a working window. In the setup menu, the deviation is in percent.

## 7.5.5. F3 Deviations

Here you can change absolute and relative deviation in percent. After auto calibration, it is checked to assure the deviations are within this limit. If the deviations are not in this limit, a warning "Deviation error!" appears.

## 7.5.6. F3 Range Limits

There are 4 different ranges. The user can define the upper range limits in ppm.



**Figure 7-20 Change Range Limits**

## 7.5.7. F1 Range 1-4 (Change Upper Range Limits)

In this menu, the upper range limits can be changed. The new settings are saved by pressing MAIN or BACK. The auto range limits are automatically adapted. This means that if the upper range limit of range 1 for example has reached 90% of the upper range limit in the auto range mode, it is switched automatically to the second range.

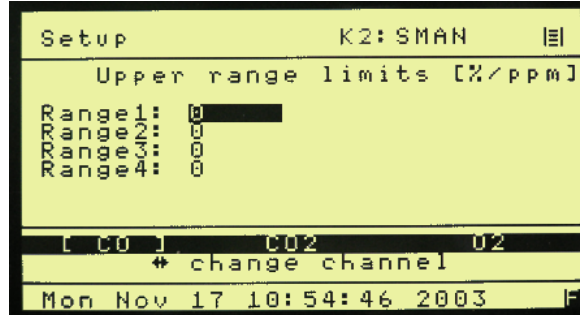

Figure 7-21 Change Upper Range Limits

## 7.5.8. F2 Change Auto Range Limits

Although the auto range limits are adapted automatically, it is possible to define them manually. Up means the value when the next higher range is selected in auto range mode, down the value when the next lower range is selected.

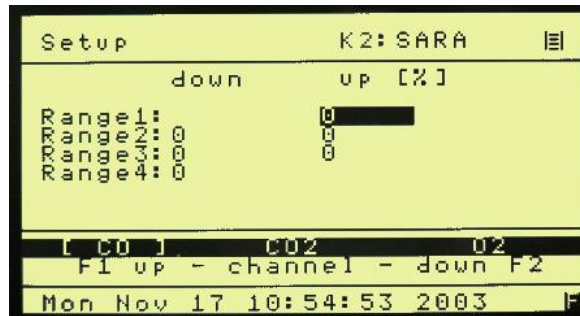

Figure 7-22 Change Auto Range Limits

## 7.5.9. F4 Alarms

Error reports are always displayed in the lowest line of the screen. There are two pressures, three temperatures, one concentration, and two voltages with alarm limits that can be defined. The user can define the range limits and, if exceeded, will display an error-message.

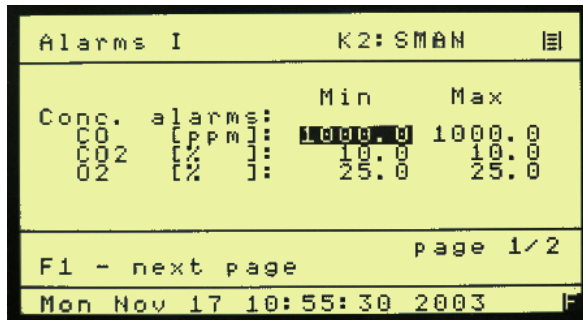

Figure 7-23 Alarm screen I

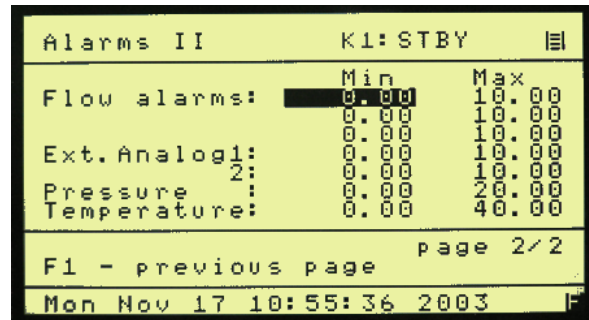

Figure 7-24 Alarm screen II

Set Temperature Alarms Set Concentration, Pressure and Voltage Alarms

## 7.5.10. F5 Password

After turning on the analyzer, you are in access level 1. To change the access level or to change the passwords, press F5 (Setup) in the main menu and Press F5 (Password) again. The following screen appears:



Figure 7-25 Enter / Change Password

## 7.5.11. F1 Enter Password

To change access level, press F1. The following screen appears:



Figure 7-26 Access Level Screen

F1 to F4 selects an access level. Move the cursor to the access level to be modified. You must enter the correct password for the access level desired. The passwords for the various operation levels consist of three numbers that must be entered on the numeric keypad. If the code word is incorrect, you are asked to re-enter the codeword.

**IMPORTANT TIP:** *When a new analyzer is powered up, it defaults to access level 1 (User). To operate ALL parameters and gain complete access, select F4. Press the Enter key twice and enter 444.*

## 7.5.12. F2 Change Password

The passwords can only be changed, if you are in access level 4. After F2, enter your new 3 digit passwords.

**IMPORTANT TIP:** *You MUST remember and record this new password. If this is lost, you will need to consult the factory for the default password!*

## 7.5.13. F3 Reset Passwords

The passwords can only be changed, if you are in access level 4. Reset passwords will revert to the factory defaults.

## 7.5.14. F6 Linearization

Pressing F6 on the Setup screen brings up the Linearization screen. The analyzer can be linearized by a polynomial with 5 coefficients. By pressing F1, these 5 coefficients can be changed for each range. By pressing F2, the raw value can be displayed. This is the value before linearization and offset span correction. There are two values on the screen: The value at the top is the linearized, offset-span-corrected value, and the other value is the raw-value.

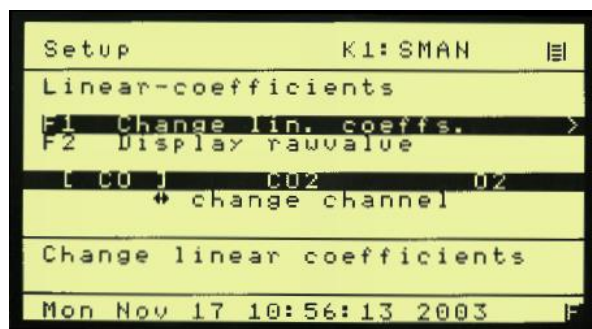

Figure 7-27 Linearization Screen

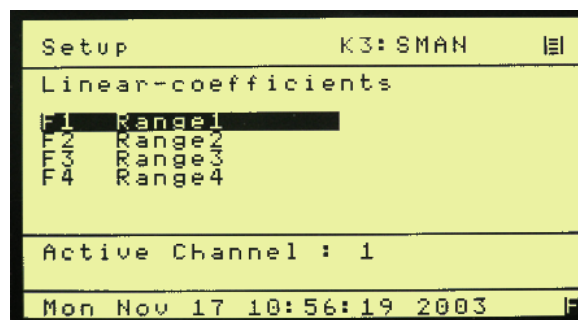

Figure 7-28 Coefficients Range Select

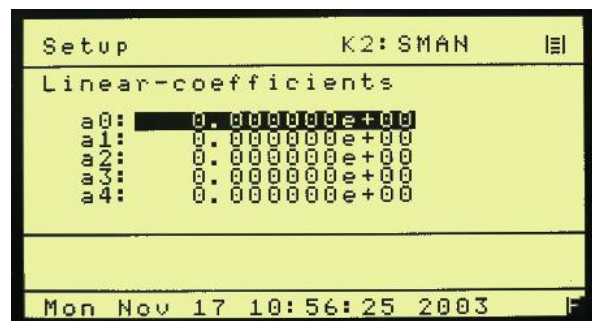

Figure 7-29 Change Coefficients

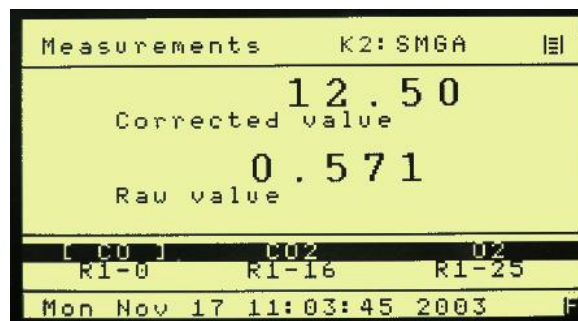

Figure 7-30 Linearized and raw data



### 7.6. F7 System Settings

This screen allows all the system settings to be displayed and modified.

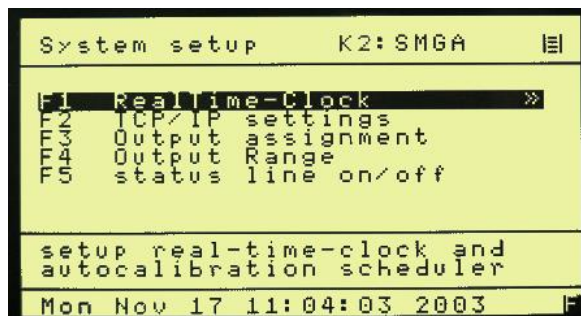

Figure 7-31 System Setup Screen

#### 7.6.1. F1 Real Time Clock

This brings up the clock time set screen; auto cal and auto cal enable screens.

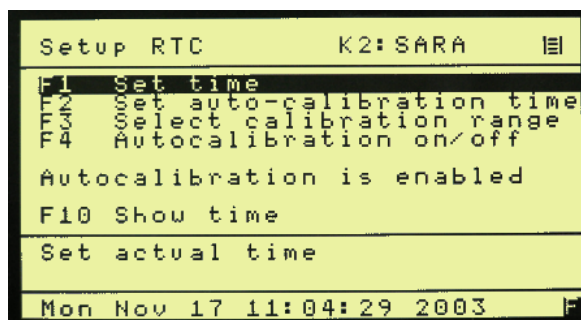

Figure 7-32 Clock and Timing Setup Screen



Figure 7-33 Clock set screen

The current time may be set by using the cursor to highlight the entry and using the numeric keys to change the values.

F2 brings up the auto cal time set. As above, the date and times can be set by using the cursor to highlight the entry and using the numeric keys to change the values. F3 Sets autocalibration ranges.

```

Setup RTC          K3:SMAN
F1 Set time
F2 Set auto-calibration time
F3 Select calibration range
F4 Autocalibration on/off

Autocalibration is enabled

F10 Show time

Setup scheduler for auto
calibration

Mon Nov 17 11:04:34 2003

```

```

schedule          K1:SMAN
Starttime : 12:00 on Wed
Date      : 11 Jun 2003
Every : 1 hour(s).
F1 - change to weekly
F2 - change to daily
F3 - change to hourly

press MAIN or BACK to exit
F1, F2, F3 to save changes

Mon Jan 01 01:09:16 2003

```

Figure 7-34 Set Auto Cal Timing

```

Range selection K1:STBY
Enter Range [0..4] : 1
Enter Channel : 1

Mon Jan 01 01:09:21 2003

```

Figure 7-35 Set Auto Cal Ranges

```

Setup RTC          K3:SMAN
F1 Set time
F2 Set auto-calibration time
F3 Select calibration range
F4 Autocalibration on/off

Autocalibration is enabled

F10 Show time

enable/disable
autocalibration

Mon Nov 17 11:04:43 2003

```

Figure 7-36 F4 Toggles Auto Cal ON of OFF



## 7.6.2. System Setup F2 Displays TCP/IP Address

```

TCP/IP setup      K1: SMGA
IP-address: 192.000.000.220
netmask : 255.255.255.000
Port : 0
Gateway : 000.000.000.000
WinIfPort: 2000
HWaddress : 00.E0.4B.01.9D.F9

enter IP-Address
take effect after reboot
Mon Nov 17 11:05:02 2003

```

Figure 7-37 TCP/IP Address

7.6.3. Systems Setup F3 Displays Output Signal Assignments  
(Used to Adjust Analog Output Channels)

```

assignment      K1: SARA
Output  Signal      Error
on AOut
1      off
2      off
3      off
4      off

Mon Nov 17 11:05:11 2003

```

Figure 7-38 Output Assignments

7.6.4. System Setup F4 Displays Output Ranges  
(Used to Adjust Scale of Analog Output Channels)

```

output ranges   K3: SMGA
Output  Limit      Mode
lower  upper
1      0           mA
2      0           mA
3      0           mA
4      0           mA

enter 0 in both fields to
use the default range.
Mon Nov 17 11:05:27 2003

```

Figure 7-39 Output Ranges

## 7.6.5. F5 Turns Status Line On or Off

The status line displays the AK Protocol action on the top line of the display.

K3: SMGA

Figure 7-40 Status line

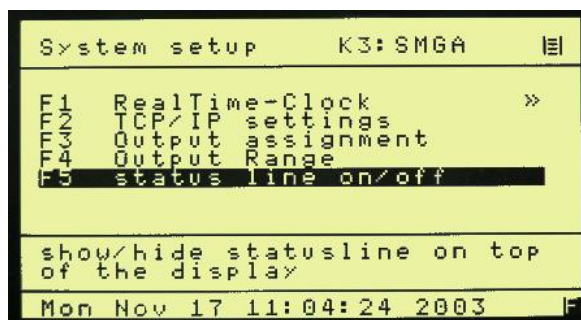

Figure 7-41 Status line on/off

## 7.6.6. F8 Measure Settings

This screen allows several of the system settings to be displayed and modified.

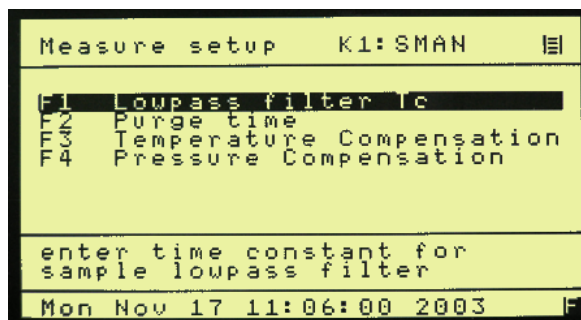

Figure 7-42 Measure setup

## 7.6.7. F1 Set Lowpass filter

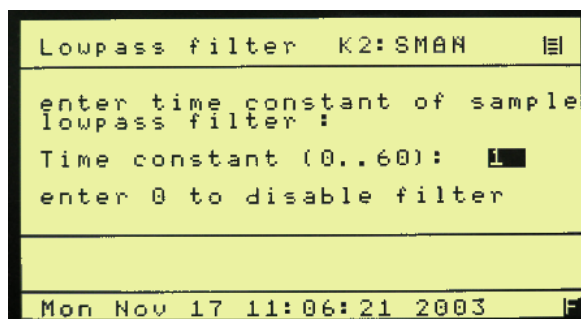

Figure 7-43 Lowpass filter

## 7.6.8. F2 Purge Time

F2 on the Menu Settings screen sets the purge time before continuing with a zero or span calibration.

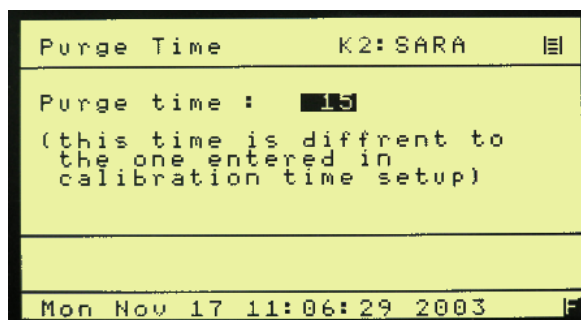

Figure 7-44 Purge Time

## 7.6.9. F3 Set Temperature Compensation

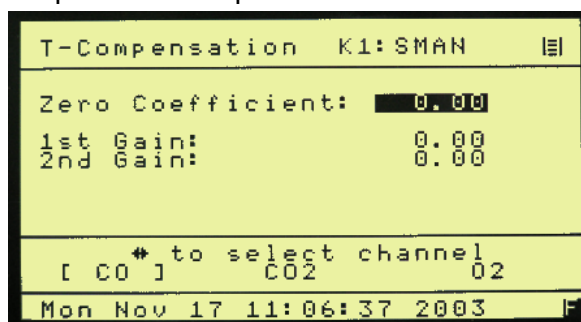

Figure 7-45 T-compensation

## 7.6.10. F4 Pressure Compensation

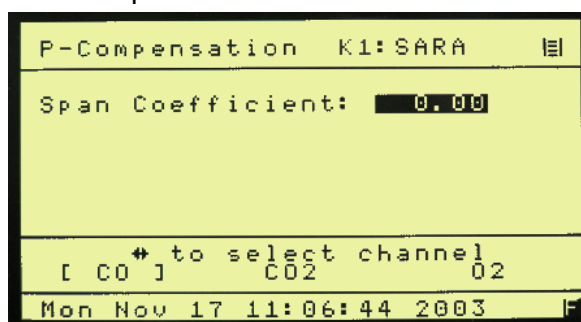

Figure 7-46 P-Compensation

## 7.6.11. F3 Low Pass Filter Time Constant

F3 on the Menu Settings screen allows the software time constant to be set between 1 and 60 seconds. This is very useful in eliminating noise when measuring low-level concentrations.

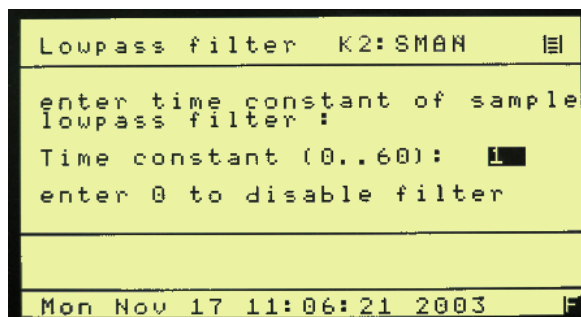

Figure 7-47 Low pass filter time constant

## 7.6.12. F10 Displays the Current Analyzer and Software Versions

This displays the analyzer's information, including the factory recommended air and sample pressure settings.

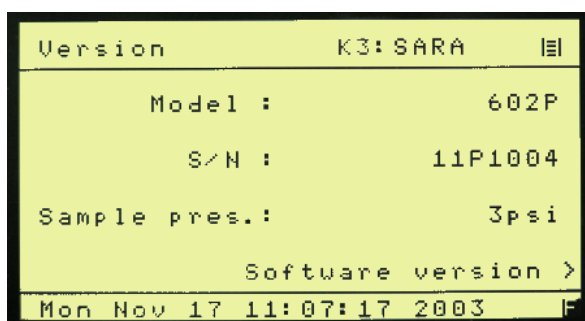

Figure 7-48 Analyzer Information

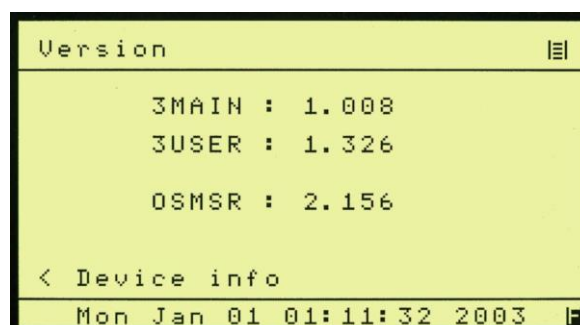

Figure 7-49 Software Version

## 7.7. F7 Remote / Manual Control

The analyzer can be remote-controlled either by a master computer or via contact closures. The TCP/IP and serial communication fully corresponds to the specifications of the AK protocol. To change remote/manual control, press F6 in the main menu. This toggles between remote and manual control.

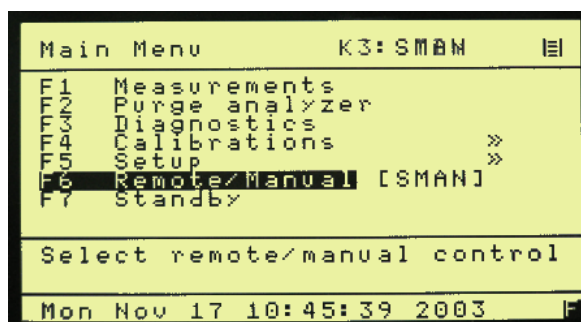

Figure 7-50 F6 Remote/Manual

## Main Menu (User Level 4)

## 7.8. F8 Standby

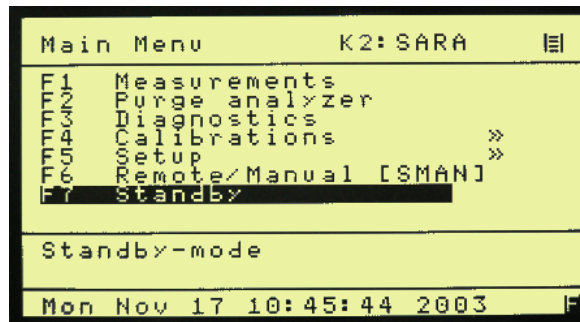

Figure 7-51 F7 Standby

**Main Menu (User Level 4)**

In Standby mode, pump is turned off and the solenoids are closed. The CAI logo is displayed.

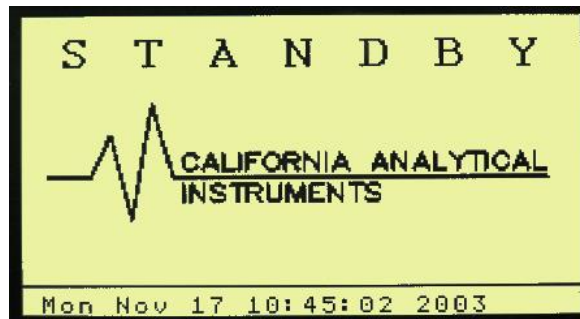
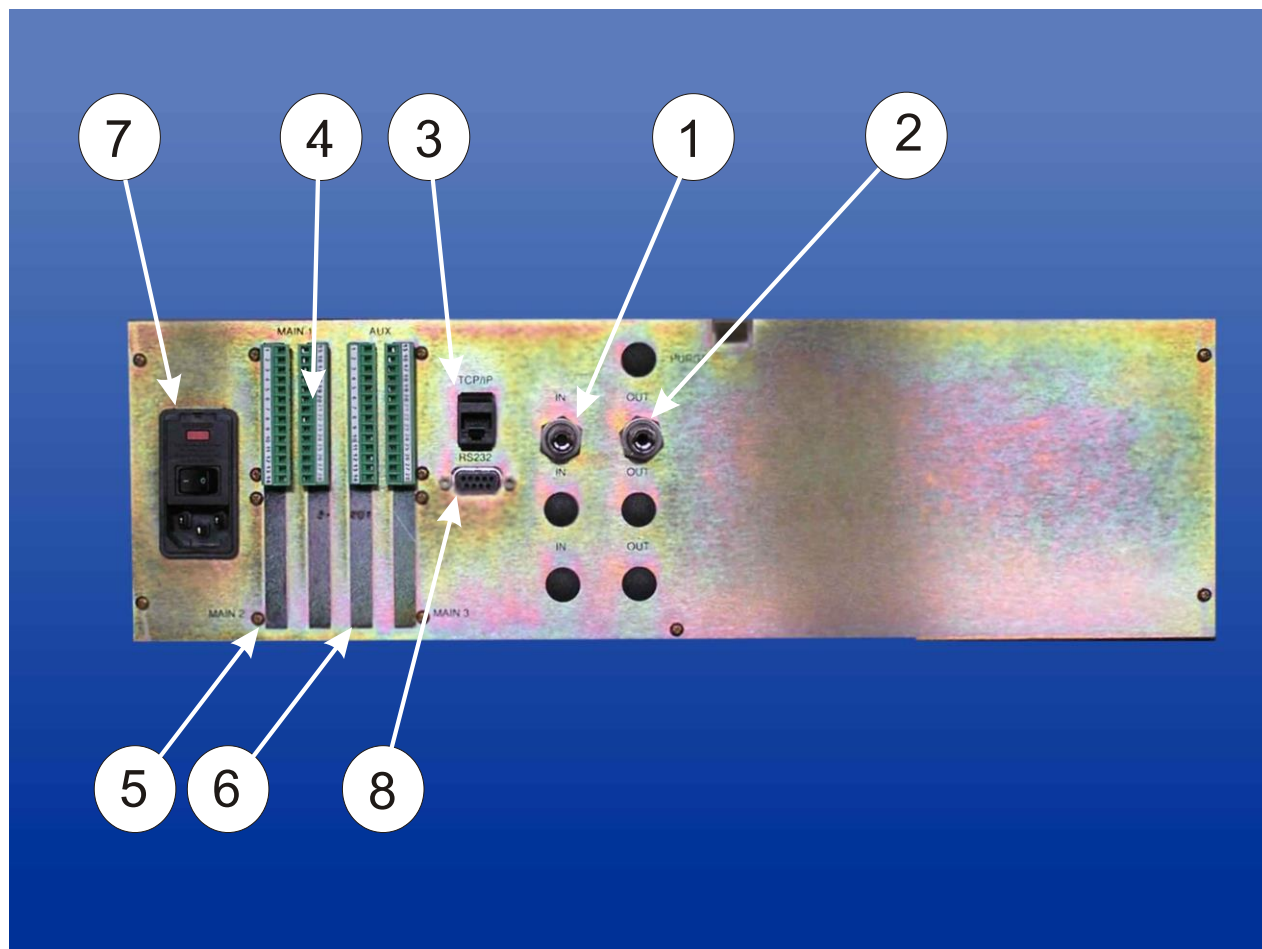

Figure 7-52 Standby Mode

## 8. Analyzer Components

### 8.1. Rear Panel

The following details the rear panel connections:



**Figure 32: Rear Panel**

- 1) **Sample Gas Inlet:** Feeds sample gas to the analyzer. ¼ Inch Tube.
- 2) **Sample Gas Bypass Outlet (Vent):** Exhaust for sample. ¼ Inch Tube.
- 3) **TCP/IP Connection:** Connect Network Connector.
- 4) 28 Pin output terminal strip/main 1 (standard).
- 5) 28 Pin output terminal strip/main 2 (optional).
- 6) 28 Pin output terminal strip/main 3 (optional).
- 7) **Power Entry Module:** Power connection, power switch, fuse compartment (2 Amp) **With Rear Panel Power ON/OFF Switch:** Turns ON/OFF line power to instrument

- 8) **Serial Connector:** Connect Serial Connector

## 8.2. Rear Panel Connectors

28 Pin <u>Main</u> Connector Assignments:						28 Pin <u>Auxiliary</u> Connector Assignments:			
Signal Type	Main 1 Analog		Main 2 Optional Analog		Main 3 Optional Analog		Signal Type	601, 602, 603 Analog	
	Pin #		Pin #		Pin #		Spare	Pin #	
A Output	1	GND (analog)	1	GND (analog)	1	GND (analog)	A Input	1	GND (analog)
A Output	2	Channel 1	2	Channel 1	2	Channel 1	A Input	2	External Analog 1
A Output	3	Channel 2	3	Channel 2	3	Channel 2	A Input	3	External Analog 2
A Output	4	Channel 3	4	Channel 3	4	Channel 3	A Input	4	Spare analog
A Output	5	Aux	5	Aux	5	Aux	A Input	5	Spare analog
		Digital		Digital		Digital	Alarms		Digital
D Output	6	GND (Digital)		GND (Digital)		GND (Digital)	D Output	6	GND (Alarm)
D Output	7	Sense AutoRange		Sense AutoRange		Sense AutoRange	D Output	7	General Alarm
D Output *	8	Sense Range 4		Sense Range 4		Sense Range 4	D Output	8	Ch. 1 Conc. 1 Alarm
D Output *	9	Sense Range 3		Sense Range 3		Sense Range 3	D Output	9	Ch. 1 Conc. 2 Alarm
D Output *	10	Sense Range 2		Sense Range 2		Sense Range 2	D Output	10	Ch. 2 Conc. 1 Alarm
D Output *	11	Sense Range 1		Sense Range 1		Sense Range 1	D Output	11	Ch. 2 Conc. 2 Alarm
		* Hi = True							
D Input	12	Set AutoRange	12	Set AutoRange	12	Set AutoRange	D Output	12	Ch. 3 Conc. 1 Alarm
D Input	13	Control Range 1	13	Control Range 1	13	Control Range 1	D Output	13	Ch. 3 Conc. 2 Alarm
D Input	14	Control Range 2	14	Control Range 2	14	Control Range 2	D Output	14	Reserved
D Input	15	Control Range 3	15	Control Range 3	15	Control Range 3	D Output	15	GND (Alarm)
D Input	16	Control Range 4	16	Control Range 4	16	Control Range 4	D Output	16	Calibration Alarm 1
D Input	17	Auto Cal	17	Auto Cal	17	Auto Cal	D Output	17	Calibration Alarm 2
D Input	18	Calibrate	18	Calibrate	18	Calibrate	D Output	18	Calibration Alarm 2
D Input	19	Zero	19	Zero	19	Zero	D Output	19	Reserved
D Input	20	Span	20	Span	20	Span	D Output	20	Spare
D Input	21	Pump	21	Pump	21	Pump	D Output	21	Spare
D Output	22	Zero Gas Flow	22	Zero Gas Flow	22	Zero Gas Flow	D Output	22	Spare
D Output	23	Span Gas Flow	23	Span Gas Flow	23	Span Gas Flow			Spare
D Output	24	Sample Gas Flow	24	Sample Gas Flow	24	Sample Gas Flow			Spare
D Output	25	Local/Remote	25	Local/Remote	25	Local/Remote			Spare
D Output	26	Read Cal Mode	26	Read Cal Mode	26	Read Cal Mode			Spare
D Output	27	Reserved	27	Reserved	27	Reserved			Spare



D Output	28	Reserved	28	Reserved	28	Reserved			Spare
----------	----	----------	----	----------	----	----------	--	--	-------

### 8.3. Digital Outputs

#### 8.3.1. RS-232 (Standard 9 Pin DIN Connector)

Pin	Function
1	DCD Carrier Detect
2	RxD Receive Data
3	TxD Transmit Data
4	DTR Data Terminal Ready
5	Ground
6	DSR Data Set Ready
7	RTS Ready to Send
8	CTS Clear to Send
9	RI Ring Indicator

#### 8.3.2. TCP/IP (8 Pin RJ-47 Connector)

Pin	Function
1	TDX+
2	TDX-
3	RXD+
4	Open
5	Open
6	RXD-
7	LNLED
8	LNLED

**IMPORTANT TIP:** For direct connect to a PC a crossover cable is required. Connection to a hub requires a straight cable.

#### 8.4. Internal Component Locations

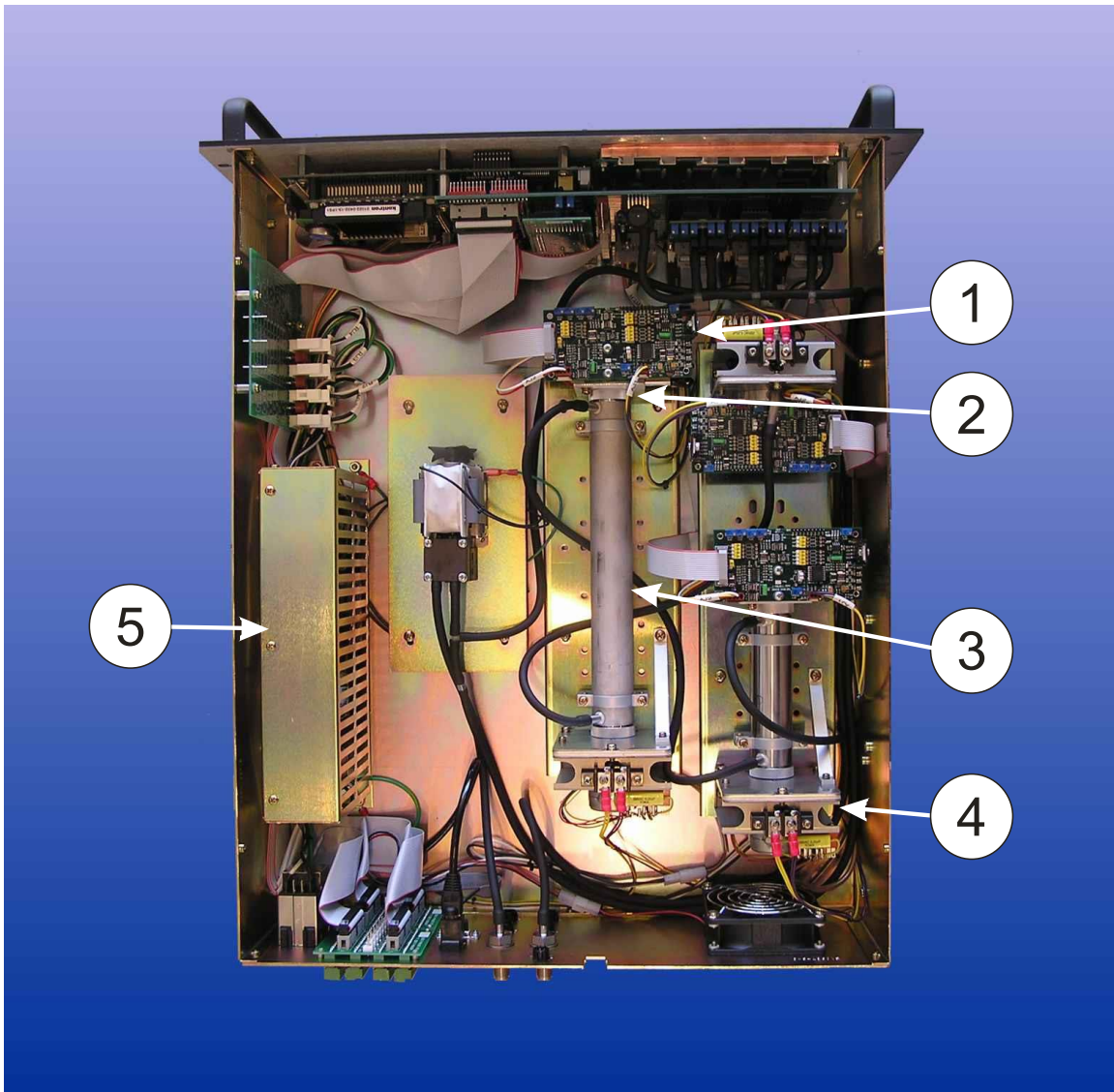

**Figure 8-1 Internal components**

- 1) Signal conditioning PCB.
- 2) NDIR detector.
- 3) Sample cell.
- 4) IR source and chopper motor assembly.
- 5) DC power supply module.



## 8.5. Main Electronics Board (Potentiometers)

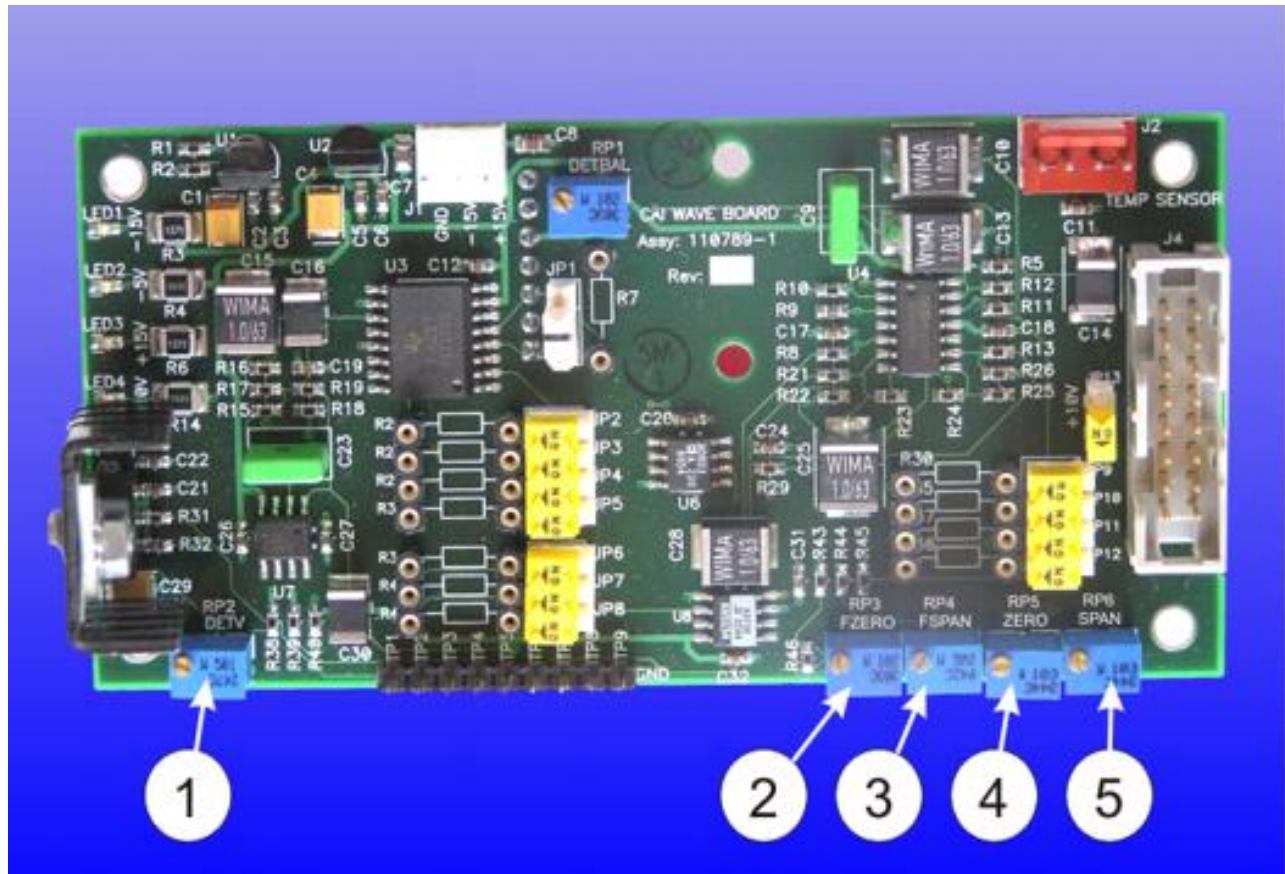
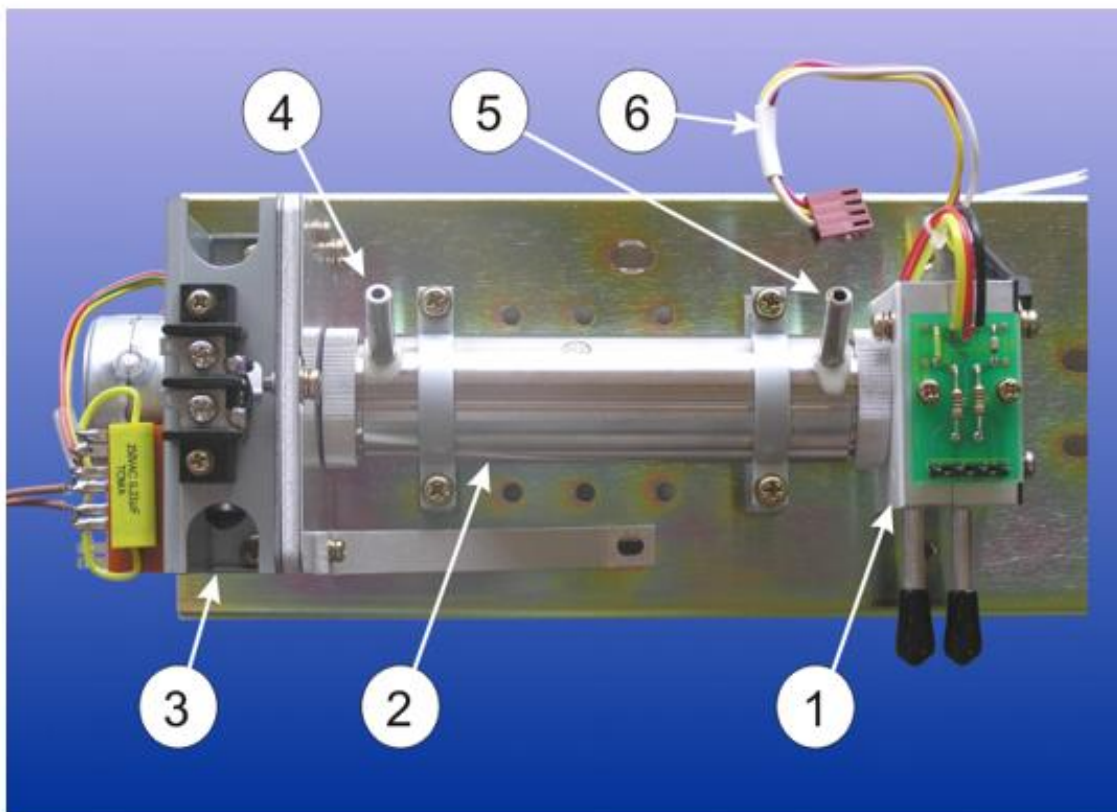

Figure 8-2 Main Electronic Board Potentiometers

- |   |     |                         |
|---|-----|-------------------------|
| 1 | RP2 | Detector voltage adjust |
| 2 | RP3 | Fine zero adjust        |
| 3 | RP4 | Not used (Fully CW)     |
| 4 | RP5 | Coarse zero adjust      |
| 5 | RP6 | Span adjust             |

**NOTE:** Potentiometers are clearly labeled on both sides of the Wave PCB.

8.6. *NDIR Detector Assembly***Figure 8-3 NDIR detector assembly**

- 1) Detector Assembly.
- 2) Sample cell assembly.
- 3) Light source and chopper motor assembly
- 4) Sample inlet.
- 5) Sample outlet.
- 6) Temperature sensing element (to J2 of Wave PCB)

## 9. Operation

### 9.1. External Wiring

Make sure that the external wires have been connected as described in Section 3 Installation.

### 9.2. External Piping

Review Section 3, 3.7 and 3.8

### 9.3. Operation & Calibration

#### 9.3.1. Power On:

Turn on the power switch (located on the rear panel). The LCD display should illuminate. Allow the instrument to warm up for approximately one hour. It is preferable, but not essential, that zero gas flow through the instrument at a rate of about 1 Liter/minute (LPM).

**Note: To achieve final stability, the analyzer may require an additional warm-up period of up to four hours (depending on variables in the analyzer's environment).**

#### 9.3.2. Zero/San Adjustment:

Follow the "Quick Start Guide" at the front of this manual.

**Note: Span gas concentration should not be less than 80% of the range to be spanned.**

#### 9.3.3. Start-Up and Routine Maintenance:

Prepare and check the sample system. Adjust the flow of sample gas to about 1 L/min. The instrument should show a meter indication. The infrared gas analyzer is designed for extended operation and may be left switched on continuously.

## 10. MAINTENANCE

### Warning

All replacement parts must be as supplied and/or specified by California Analytical Instruments. Failure to use specified parts may reduce the safety features of the instrument or create a hazardous condition.

#### 10.1. Zero and Span Calibration

The zero and span levels should be checked and/or calibrated daily (or as often as required.)

#### 10.2. Cleaning of the Optical Bench Measuring Cell (Infrared Analyzers Only)

Dust or water droplets entering the measuring cell may cause drift due to contamination. When it is impossible to adjust the zero level with the zero control mounted on the front panel, check the measuring cell for contamination. If contamination is present, check the sampling system, especially the filters, to eliminate the source of contamination. Periodic maintenance is generally not required. Cleaning is accomplished by use of a cleaning agent (such as isopropyl alcohol or household glass cleaner) and a non-abrasive, lint-free cloth or tissue.

#### 10.3. Optical Bench Configuration

Infrared analyzers may be configured with three types of optical benches: with a pipe cell; with a block cell; or with both a pipe cell and a block cell (see Table 10-1))

**Table 10-1 Optical Bench Configuration**

Optical Bench Type	Illustration	Paragraph
Pipe Cell (Cell length: 64 mm, 125 mm, or 250 mm).	Figure 10-1 This figure illustrates the pipe cell	10.3.1 describes the disassembly cleaning and reassembly
Block Cell (Cell length: 4 mm, 8 mm, 16 mm or 32 mm)	Figure 10-2 This figure illustrates the block cell.	10.3.2 describes the disassembly cleaning and reassembly
Combination	Figure 10-3 This illustrates the combination assembly.	10.3.3 describes the disassembly cleaning and reassembly

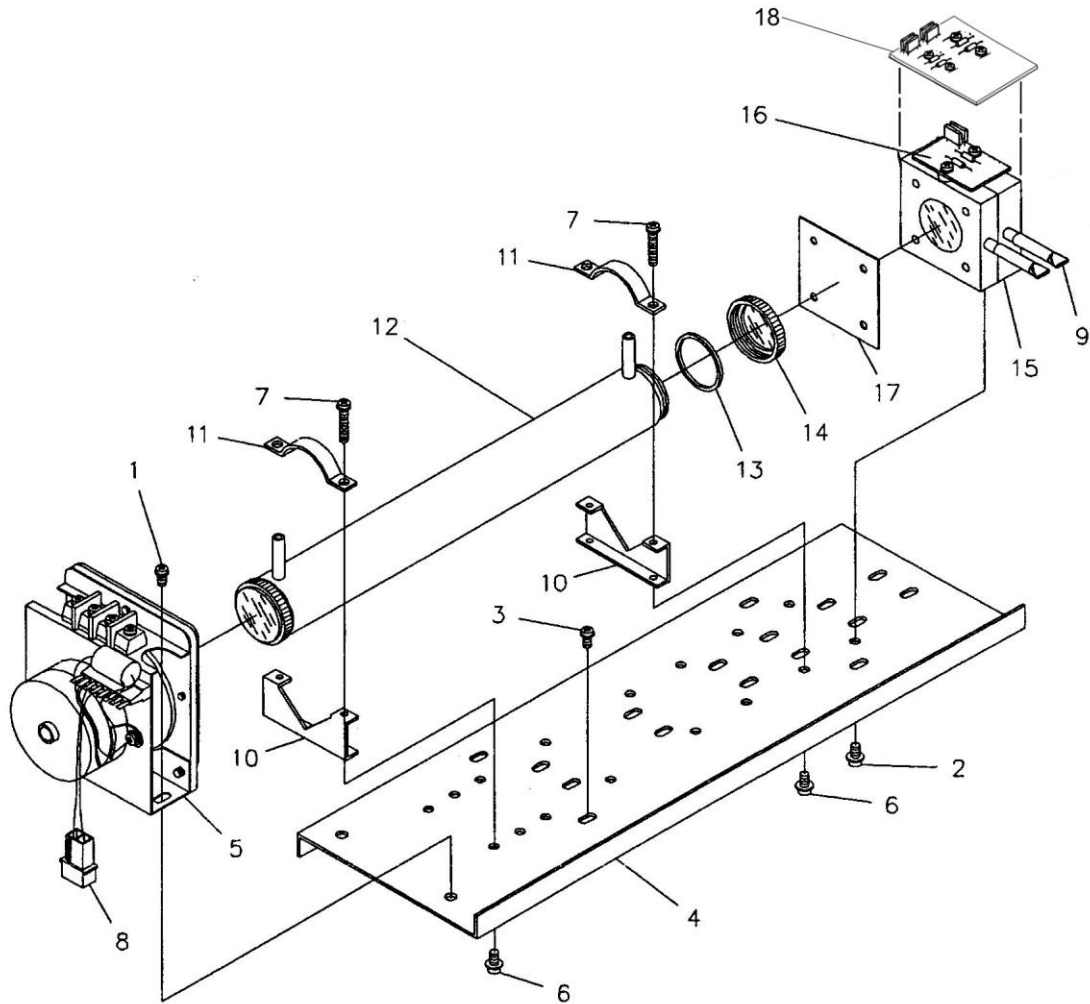

Figure 10-1 Optical Bench with Pipe Sample Cell

Item	Description	Item	Description
1-3	Screw (M4)	12	Pipe sample cell
4	Base	13	O-Ring
5	Infrared source unit	14	Window
6-7	Screw (M4)	15	Detector
8	Connector	16	Bridge circuit board
9	Sealed tubes	17	Optical filter (if installed)
10	Support	18	Wave PCB
11	Clamp		

**Note:** Pipe cell foil liner not shown



**10.4. Removal of Pipe Cell**

(Figure 10-1)

- 1) Discontinue the sample gas flow. When it contains harmful gas, purge the measuring cell sufficiently with zero gas.
- 2) Turn the power switch to OFF.
- 3) After loosening the retaining screws on the sides of the top cover, lift off top cover and locate the pipe cell.
- 4) Disconnect the sample gas inlet and outlet tubes from the measuring cell.
- 5) After loosening (do not remove) the two screws (No. 1 in Figure 10-1) which are used for securing the infrared light source unit (No. 5 in Figure 10-1) to the base plate, shift the infrared light source away from the pipe cell (No. 12 in Figure 10-1) to form a gap.
- 6) After removing the pipe cell retainer screws (No. 7 in Figure 10-1), remove the retaining clamps (No. 11 in Figure 10-1).
- 7) Carefully remove the cell from the optical bench and remove both windows (right-hand threaded) (No. 14 in Figure 5-1).
- 8) At this time, inspect the O-Ring (No. 13 in Figure 10-1) for signs of deterioration. Replace if necessary.
- 9) The CaF<sub>2</sub> window is bonded to the window holder. Inspect and clean the windows as necessary using cotton swabs and a suitable cleaning solution.

***Alcohol or an alcohol-based glass cleaner is a suitable cleaning solution. A soft cloth or tissue that will not deposit lint should be used to clean the liner & windows.***

- 10) The pipe cells contain a reflective metal foil liner (not shown in Figure 10-1) to enhance the light energy through put in the cell. Normally it is not necessary to remove the liner for cleaning; however, the liner should be removed if the cell is subjected to grossly excessive moisture. If necessary, clean both sides of the liner and the inside of the pipe cell. If the liner has been subjected to a corrosive substance, it should be replaced. In either case, ensure that the small gas holes in the liner are aligned with the gas fittings at both ends of the pipe cell before reassembling the windows.
- 11) The pipe cell can be re-assembled by following the reverse of the disassembly procedures. In re-assembly, reserve gaps of approximately 0.5 mm between the infrared light source unit and cell and between the cell and detector, respectively. Larger gaps are undesirable.

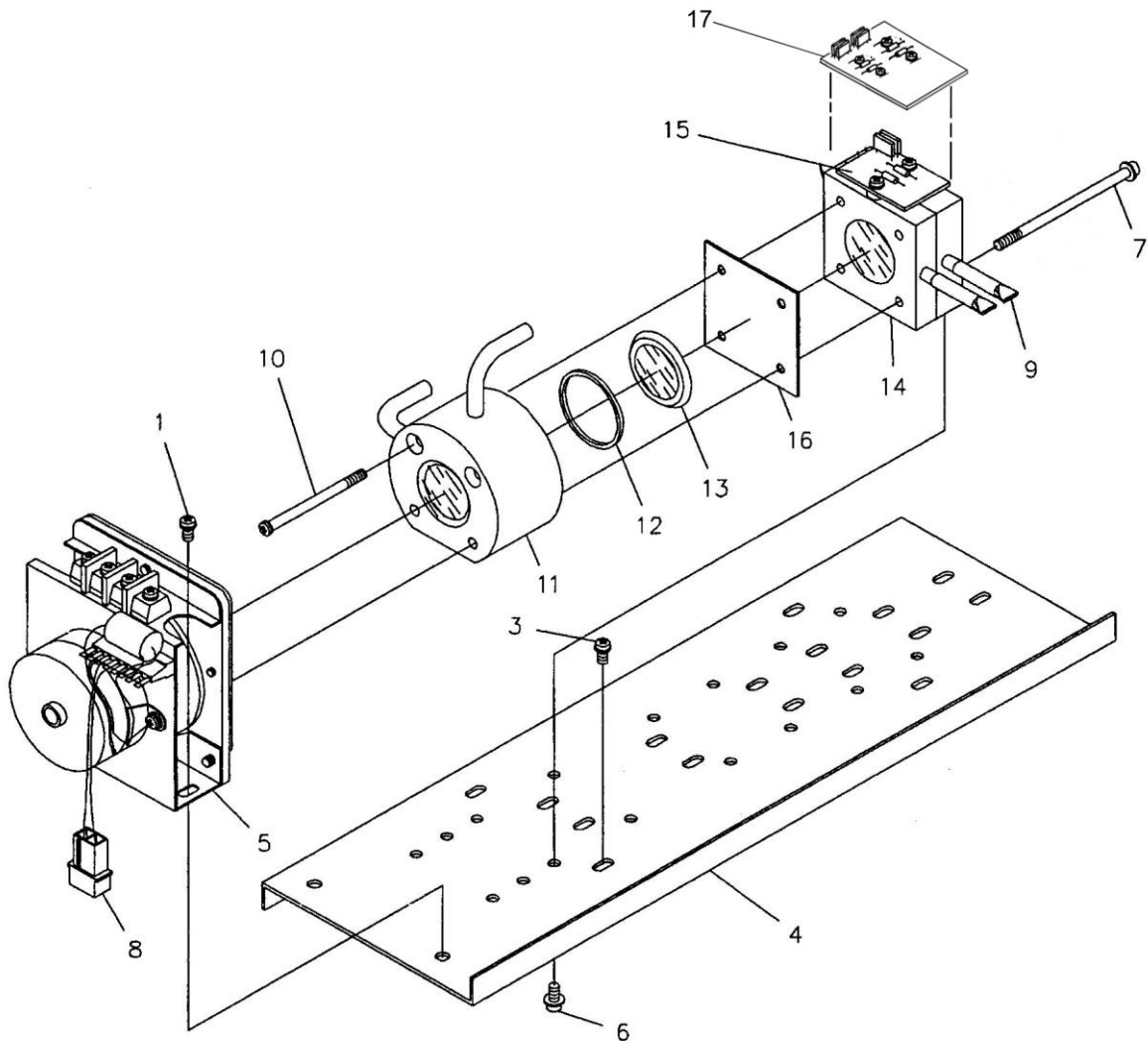

Figure 10-2 Optical Bench with Block Sample Cell

Item	Description	Item	Description
1-3	Screw (M4)	11	Block sample cell
4	Base	12	O-Ring
5	Infrared source unit	13	Window
6	Screw (M4)	14	Detector
7	Screw (Round or Pan Head)	15	Bridge circuit board
8	Connector	16	Optical filter (if installed)
9	Sealed tubes	17	Wave PCB
10	Screw (Flat Head)		

**10.5. Removal of Block Cell**

(Figure 10-2)

- 1) Discontinue the sample gas flow. When it contains harmful gas, purge the measuring cell sufficiently with zero gas.
- 2) Turn the power switch to OFF.
- 3) After loosening the retaining screws on the sides of the top cover, lift off the top cover and locate the block cell.
- 4) Disconnect the sample gas inlet and outlet tubes from the measuring cell.
- 5) Disconnect the detector output-cable-connector from the main circuit board.
- 6) Remove the two screws (No. 7 in Figure 10-2) attaching the detector to the infrared light source assembly and remove the detector from the optical bench. The cell is removed together with the detector as a unit.
- 7) While holding the detector in the palm of your hand, remove the two flat-head screws (No. 10 in figure 10-2) which fix the cell to the detector.

***Note: The cell window (No. 10 in figure 10-2) is loose and is only retained by the clamping action between the detector and the block sample cell. Take care not to drop the window when separating the block cell from the detector.***

- 8) Clean the cell interior and CaF<sub>2</sub> windows using a soft cloth or tissue (see Note on previous page). Inspect the O-Ring for flatness or deterioration and replace if necessary.
- 9) The block cell can be re-assembled by following the reverse of the disassembly procedures. Note the orientation of the loose window and O-ring during disassembly.

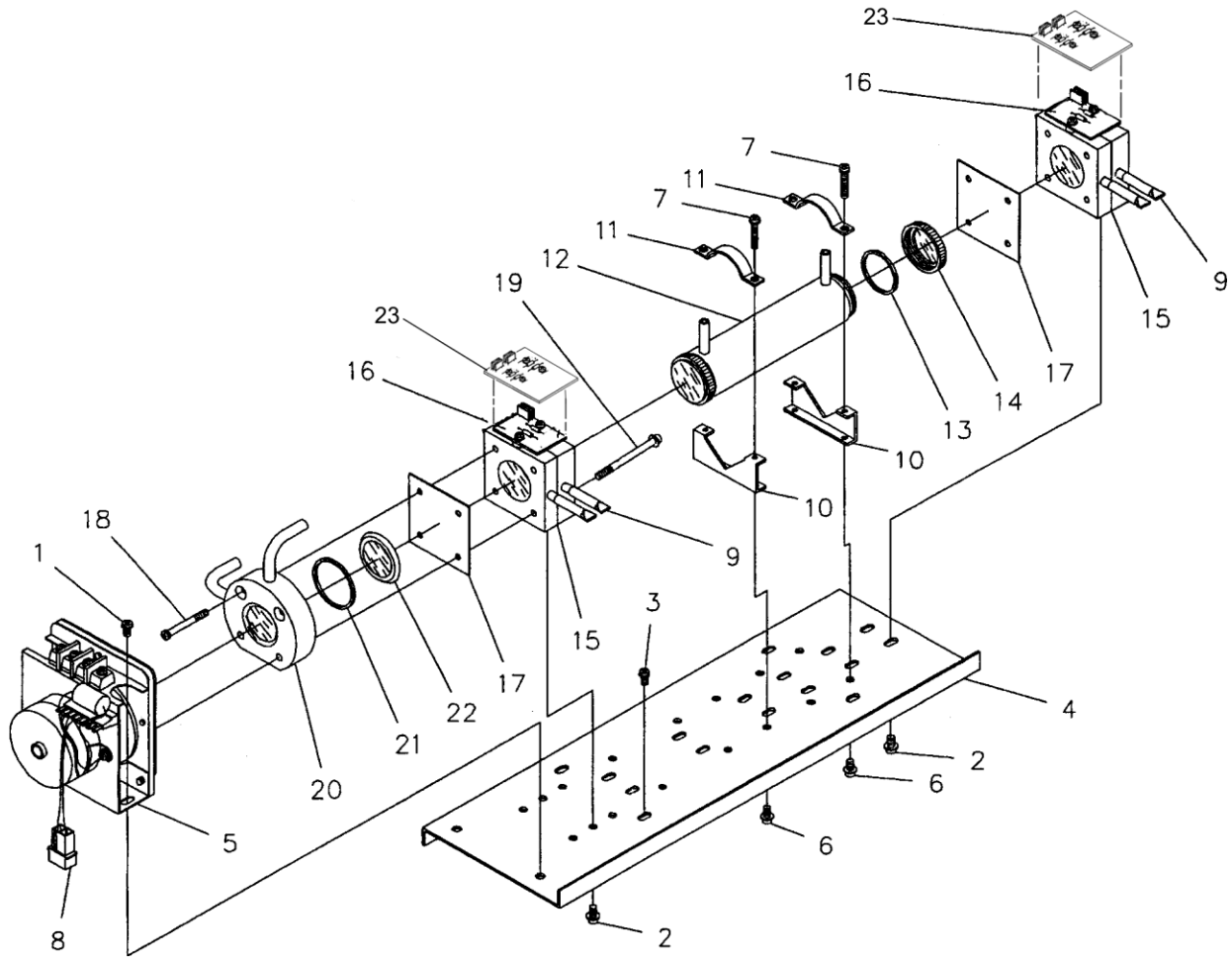

Figure 10-3 Optical Bench with Pipe and Block Type Sample Cells

Item	Description	Item	Description
1-3	Screw (M4)	14	Window
4	Base	15	Detector
5	Infrared source unit	16	Bridge circuit board
6	Screw (M4)	17	Optical filter (if installed)
7	Screw	18	Screw (Flat Head)
8	Connector	19	Screw (Round or Flat Head)
9	Sealed tubes	20	Block Sample Cell
10	Support	21	O-Ring
11	Clamp	22	Window
12	Pipe sample cell	23	Wave PCB
13	O-Ring		

**10.6. Disassembly of Combination Pipe & Block Type Cells**

(Figure 10-3)

- 1) Discontinue the sample gas flow. When it contains harmful gas, purge the measuring cell sufficiently with zero gas.
- 2) Turn OFF the power switch.
- 3) After loosening the retaining screws on the sides of the top cover, lift off top cover and locate the block cell.
- 4) Disconnect the inlet and outlet tube from both measuring cells.
- 5) Disconnect the wires from the two terminal screws of the infrared source unit and unplug the 2-pin connector (No. 8 in figure 10-3) from the chopper motor.
- 6) Disconnect the block cell's detector output-cable-connector from the main circuit board.
- 7) Remove the two screws (No. 1 in figure 10-3) that secure the infrared source unit to the base.
- 8) Remove the sub-assembly consisting of the source unit, block cell, and detector.
- 9) Remove the two screws (No. 19 in figure 10-3) that secure the detector to the infrared source then separate the detector and block cell from the infrared source unit.
- 10) While holding the detector in the palm of your hand, remove the two flat-head screws (No. 18 in figure 10-3) which fix the cell to the detector.

**Note: the cell window (No. 10 in figure 10-3) is loose and is only retained by the clamping action between the detector and the block ample cell Take care not to drop the window when separating the block cell from the detector.**

- 11) Clean the cell interior and CaF<sub>2</sub> windows using a soft cloth or tissue (see Note on previous page). Inspect the O-Ring for flatness or deterioration and replace if necessary.
- 12) The block cell can be re-assembled by following the reverse of the disassembly procedures. Note the orientation of the loose window and O-ring during disassembly.

**Note: Before re-installing the infrared source unit, block cell and detector sub-assembly you should first remove and clean the pipe cell.**

- 13) Remove the pipe cell retaining screws (No. 7 in figure 10-3)
- 14) Remove the retaining clamps (No. 11 in figure 10-3).
- 15) Lift the pipe cell out of its two supports (No. 10. in figure 10-3) and remove both windows (right-hand threaded) (No. 14 in figure 10-3).
- 16) At this time, inspect the O-Ring (No. 13 in Figure 10-3) for signs of deterioration. Replace if necessary.
- 17) The CaF<sub>2</sub> window is bonded to the window holder. Inspect and clean the windows as necessary using cotton swabs and a suitable cleaning solution.

***Alcohol or an alcohol-based glass cleaner is a suitable cleaning solution. A soft cloth or tissue that will not deposit lint should be used to clean the liner & windows.***

- 18) The pipe cells contain a reflective metal foil liner (not shown in Figure 10-3) to enhance the light energy through put in the cell. Normally it is not necessary to remove the liner for cleaning; however, the liner should be removed if the cell is subjected to grossly excessive moisture. If necessary, clean both sides of the liner and the inside of the pipe cell. If the liner has been subjected to a corrosive substance, it should be replaced. In either case, ensure that the small gas holes in the liner are aligned with the gas fittings at both ends of the pipe cell before reassembling the windows.
- 19) The pipe cell can be re-assembled and installed by placing it in its supports and securing with its retaining brackets.

***Note: Before tightening the retaining brackets, be certain that a gap of approximately 0.5-1.0 mm exists between the pipe cell and the pipe cell detector.***

- 20) Reinstall the infrared source unit, block cell and detector sub-assembly by performing steps e, f, g, h, and I in reverse, being sure to leave a slight gap of approximately 0.5-1.0 mm between the back of the block cell and the front pipe-cell window.

## 11. ADJUSTMENTS CHECKS AND REPAIRS

### 11.1. Adjustment of Detector Voltage (NDIR'S only)

**Note:** Adjustment is required if detector or NDIR amplifier board is replaced. **Important:** Turn RP2 to its maximum counter clockwise position before initial power up of a replacement detector or NDIR.

The detector operating voltage is specified on the label attached to the side of the detector below the Serialization Number and Type designation. On the NDIR amplifier board, the voltage supplied to the detector can be measured between TP-1 (+) and TP-9 (common). Adjust RP2 to achieve the voltage specified on the detector to within 0.001 VDC.

**WARNING:** The detector may be damaged if the applied voltage is excessive. For this reason, it is recommended to adjust RP2 to its maximum counter clockwise position before initial power up of a replacement detector or NDIR amplifier board.

### 11.2. Coarse Zero Adjustment

With zero gas still flowing connect a DC voltmeter to TP7 (+) and TP9 (common). Switch JP8 to the on position and leave JP6 and JP7 in the off position. The target DC voltage for TP7 is 0mV. Adjust RP5 first and use RP3 for the final adjustment.

### 11.3. Span Gain Adjustment

With a full-scale span gas flowing connect a DC voltmeter to TP8 (+) and TP9 (common). The target voltage for TP8 with a full-scale span gas flowing is 8.00VDC. Turn RP4 fully clockwise (12 turns). To achieve this voltage select a resistor value, or combination of values to install into R30, R35, R36, and / or R37. Set the corresponding Jumper (JP9-JP12) to the on position for each resistor used to set the gain. The value needed may range between 1K and 100K ohms. A smaller resistor value increases the gain and achieves a larger DC voltage at TP8 when span gas is flowing. RP6 can be used to make a small gain adjustment when the target voltage is close. When finished setting the gain adjustment, flow zero gas again and repeat the previous to step to achieve a good zero at TP8.

**11.4. Check and Repair Detector**

(No. 15 in Figure 10-1 and Figure 10-3, No. 14 in Figure 10-2)

**11.4.1. Problem:**

Microflow sensor broken, bridge resistor defective or gas leak in detector.

**11.4.2. Symptom:**

Zero adjustment impossible.

**11.4.3. Check and/or replace:**

- 1) The microflow sensor and bridge resistors (No. 16 in Figure 10-1) are normal when DC voltages of about 1.5 to 2V are measured between bridge circuit board terminals numbered 1-3 and between terminals numbered 2-3, respectively, and the difference between these voltages is a few tenths of a volt. These two voltage readings can be measured from the top of the NDIR amplifier board between ground (TP9) and pin 1 of J3 and pin 3 of J3 respectively when R7 is removed. J3 is not labeled on the top of the circuit board as it is mounted on the bottom side of the circuit board. The pins are accessible on the top of the board between U3 and JP1. Pin 1 is designated with a square pad.
- 2) Connect an oscilloscope between the NDIR amplifier board check terminals TPp (common) and TP3. When the NDIR amplifier board, infrared light source unit, and chopper are normal, but ac waveform (approximately 10 Hz) is not observable at TP3, gas is leaking in the detector and the detector should be replaced.
- 3) When check in item 1 (above) indicates abnormal voltage, turn the power switch to OFF, and disassemble the NDIR amplifier board from the top of the detector to access the bridge circuit board mounted on the detector.
- 4) Check the microflow sensor for its resistance. Measure resistance values between terminals 1-3 and between terminals 2-3, respectively, on the bridge circuit board. When the resistance values are about 25 to 50 ohms, the microflow sensor is normal, but the bridge resistor is defective. If the resistance is infinite, the microflow sensor is faulty.
- 5) Replacement: Replace the detector with a new one (refer to 10-1). If the instrument is using the pipe cell, the detector is attached to the optical bench from below. Remove the four screws (No. 3 of Figures 10-1 and 10-3) that secure the base (No. 4 of Figures 10-1 and 10-3) to access the detectors retaining screws (No. 2 of figures 10-1 and 10-3).
- 6) After the detector has been replaced, adjust the detector voltage to the specified value (refer to section 11.1 of this manual).
- 7) Adjust zero and span.



**11.5. Check and Repair Infrared Light Source Unit**

(No. 5 in Figure 10-1)

**11.5.1. Problem:**

A faulty infrared light source or a leaky gas seal.

**11.5.2. Symptom:**

The unit reads off scale or the output is unstable.

**11.5.3. Check and/or replace:**

- 1) After turning the power switch to OFF and disconnecting the lead wires from the two terminal screws, measure the resistance between the two terminals. The resistance should normally be about 38 ohms. If the resistance is infinite, the infrared light source is faulty (Output drifts in the negative direction as resistance decreases).
- 2) When indicator output drifts due to influence from atmosphere in spite of normal operations of the detector and main circuit board, gas may be leaking into the infrared light source unit.

**Note: In the case of a low-concentration CO<sub>2</sub> analyzer, the indicator output may fluctuate due to atmospheric CO<sub>2</sub> penetrating the gaps in the optical bench. This would be normal and not necessarily indicative of a problem. Purge the analyzer case with N<sub>2</sub> gas.**

- 3) Replacement: After disconnecting wires from the two terminal screws and motor connector, remove the two screws that are used to attach the infrared light source unit to the optical bench. The light source assembly can be replaced, referring to Figure 10-1 or Figure 10-2.
- 4) After replacement of the infrared light source unit, adjust the zero level and span.

**11.6. Check and Replace Chopper**

(See Figure 2-1)

**11.6.1. Problem:**

Rotation abnormal.

**11.6.2. Symptom:**

Indicator output unstable or unresponsive.

**11.6.3. Check and/or replace:**

- 1) With the power switch turned ON, listen for a frictional noise from the chopper blade. If noise can be heard, it is necessary to adjust the chopper blade so that no contact is made with other parts. Remove the infrared light source assembly and detach the protective cover for access to the chopper blade. Take care not to damage the blade, as it is made of thin material. No adjustment is required as long as the output is normal.

- 2) If the motor shaft does not rotate after energizing the instrument, disconnect the power supply connector from the motor and check to see if AC 100 Volts is supplied to the connector on the power supply side. When power is supplied but the motor shaft does not rotate, check the shaft and blade sector for an obstruction. When the motor does not rotate, and there is no abnormal contact on the shaft or sector blade, the motor itself is defective.
- 3) Replacement: When the motor is defective, the infrared light source assembly must be replaced.

### **11.7. Check and Repair Measuring Cell**

#### Detector Window and Infrared Light Source Window

##### 11.7.1. Problem:

Cell and window badly contaminated.

##### 11.7.2. Symptom:

Zero adjustment impossible.

##### 11.7.3. Check and or replace:

After removing the measuring cell, check the cell and windows for contamination. If contaminated, remove contaminant with a soft cloth and alcohol. Take care not to damage the windows since they are fragile. For details, refer to section 10 of this manual.

### **11.8. Check and Repair Tubing Trouble**

##### 11.8.1. Problem:

Tubing loosened, disconnected, contaminated, or restricted.

##### 11.8.2. Symptom

Indicator output unstable or response is too slow.

##### 11.8.3. Check and/or replace:

- 1) When tubing is disconnected or loosened, firmly reconnect it.
- 2) When tubing is contaminated or restricted, disconnect it and blow out contaminants with high-pressure air, or replace the tubing.

### **Caution**

**Cracked, broken or frayed tubing may cause a hazardous condition. Replacement tubing must be as specified by California Analytical Instruments to prevent possible damage to operating personnel or equipment.**

### 11.9. Check and Repair Amplifier Circuit

- 1) Connect an oscilloscope across check terminals TP3 (signal) and TP9 (common) and observe the ac waveform. While zero gas is flowing, the amplitude of the waveform should be between 2.48Vpp and 2.8Vpp as shown below. This can be adjusted by following the procedure described under section 12.2 before making this adjustment it is recommended that a check for contamination in the cell and cell windows be done first, as this can lead to a reduction in amplitude of the ac signal. **Note: Check cell first for contamination and clean if necessary.**

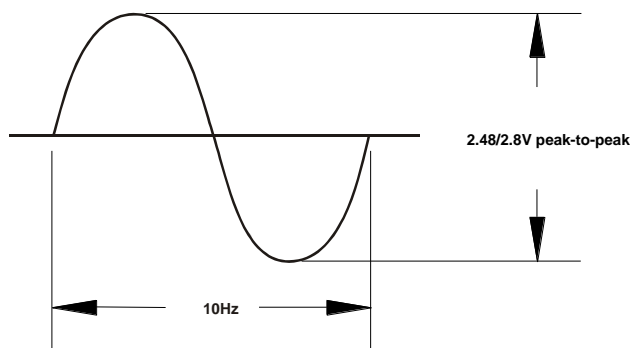

**Figure 11-1 Amplifier circuit ac wave form**

- 2) If an ac waveform cannot be observed in step a) above, observe the ac waveform across terminals TP4 (signal) and TP9 (common). If an ac waveform of 10 Hz and "peak-to-peak" amplitude of 147mV to 164mV is observed, ac amplifier U1 is normal and AC amplifier U7 is not functioning.
- 3) If an AC Waveform is not observed across terminals TP4 (signal) and TP9 (common), check the detector per section 12.4 of this manual.

## 12. Communication Master Computer / Analyzer (AK Protocol)

### 12.1. Serial Interface and AK-Commands

The serial interface enables remote control of the analyzer by a master computer. It is implemented as an RS232 V24 interface and meets all requirements of the AK protocol.

A 9-pin male connector at the back of the unit is used to connect a master computer with the following pin assignment:

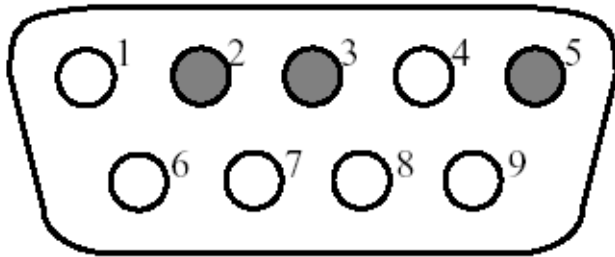

Pin 2 = Rxd (receive)

Pin 3 = Txd (transmit)

Pin 5 = Gnd (ground)

Figure 12-1 Serial Interface

### 12.2. Interface Specifications

Speed:	9600 bps
Character Length	1 start bit
	8 data bits
	1 stop bit
Parity:	none
Handshake	no

### 12.3. Protocol Description

#### 12.3.1. Instruction command

	Character	Explanation
1 <sup>st</sup> Byte	STX	ASCII code 02
2 <sup>nd</sup> Byte	Don't Care	Any ASCII code
3 <sup>rd</sup> Byte	Function Code 1	AK instruction e.g.: ASTF
4 <sup>th</sup> Byte	Function Code 2	
5 <sup>th</sup> Byte	Function Code 3	
6 <sup>th</sup> Byte	Function Code 4	
7 <sup>th</sup> Byte	Blank	
8 <sup>th</sup> Byte	K	
9 <sup>th</sup> Byte	0	
10 <sup>th</sup> Byte	Blank	
	D	AK instruction parameters, length is variable
	A	
	T	
	A	
nth Byte	ETX	ASCII code 03

**Table 12-1 Structure of an instruction command**

#### 12.3.2. Acknowledgement command

	Character	Explanation
1 <sup>st</sup> Byte	STX	ASCII code 02
2 <sup>nd</sup> Byte	Don't Care	Any ASCII code
3 <sup>rd</sup> Byte	Function Code 1	Echo of the AK instruction command
4 <sup>th</sup> Byte	Function Code 2	
5 <sup>th</sup> Byte	Function Code 3	
6 <sup>th</sup> Byte	Function Code 4	
7 <sup>th</sup> Byte	Blank	
8 <sup>th</sup> Byte	K	
9 <sup>th</sup> Byte	0	
10 <sup>th</sup> Byte	Blank	
	D	AK acknowledgement parameters, length is variable
	A	
	T	
	A	
nth Byte	ETX	ASCII code 03

**Table 12-2 Structure of an acknowledgement command****12.3.3. Data Description**

Each command begins with STX (Start of Text) in the first byte. The “don't care” byte can be any ASCII character. Generally, a blank or an underscore ( \_ ) is used for readability reasons. The four function bytes represent the AK command. A blank comes next, followed by K and the channel number. The analyzer is a single-channel device, and because of that the channel number is usually 0. For delimiting the command parameters from the channel number, another blank follows. This may be followed by command parameters with a variable length. Every command ends with the ETX (End of Text) character. The error status byte in the acknowledgment command signals if internal errors in the analyzer occurred. It is zero when no error appeared, and it is unequal zero when one or more errors occurred. Every time a change in the errors happens the error status byte is incremented by one, no matter if one or several errors disappear or are added. If it had the value 10, it would be reset to 1. The error status byte does not indicate the real number of errors. If the analyzer does not have errors, the error status byte contains the value 0.

In general, AK commands are subdivided into three classes:

- Control commands (Sxxx)
- Inquiry commands (Axxx)
- Configuration commands (Exxx)

**12.3.4. Error Handling**

It might happen that an unknown instruction is sent, that the analyzer is busy with a function which is not the desired one, or that an error occurred in the command parameters. Table 1-4 summarizes all errors that can appear upon any master instruction.

<b>Analyzers Acknowledgement</b>	<b>Explanation</b>
???? f1	Analyzer does not know the instruction sent.
xxxx <sup>2</sup> f BS	Analyzer is busy with another function.
xxxx f SE	Syntax error within command parameters or incomplete command.
xxxx f NA	Requested function or data are not available.
xxxx f DF	Data error: The kind or number of given parameters are not valid.
xxxx f OF	Offline: Analyzer is offline, i.e. analyzer is in local Mode. Only inquiry commands and SREM (set analyzer in remote mode) are allowed.

**Table 12-3 Acknowledgment response in case of error**

<sup>1</sup> f stands for the error status byte.

<sup>2</sup> xxxx stands for the function code of the sent master command

**12.4. Scan Commands****12.4.1. AKON: Measured concentration value**

Command	Response	Description
_AKON_K0	_AKON_s_z.z_y.y_x.x_w.w	Measured concentration value of all channels is responded t = Timestamp (1/10 sec)
_AKON_Km	_AKON_s_z.z_t	Measured concentration value of channel m is responded t = Timestamp (1/10 sec)

**12.4.2. AEMB: Get measuring range**

Command	Response	Description
_AEMB_K0	_AEMB_s_Mn_Mn_Mn	Current measuring range of all channels is responded
_AEMB_Km	_AKON_s_Mn	Current measuring range of channel m is responded

**12.4.3. AMBE: Measuring range limit**

Command	Response	Description
_AMBE_K0	_AMBE_s_M1_w.w _M2_x.x _M3_y.y _M4_z.z	All existing measuring range limits of channel m are responded
_AMBE_K0_Mn	_AMBE_s_Mn_z.z	Range limit of Range Mn is responded

**12.4.4. AKAK: Calibration gas concentrations**

Command	Response	Description
_AKAK_Km	_AKAK_s_M1_w.w _M2_x.x _M3_y.y _M4_z.z	All existing calibration gas values are responded for selected channel m
_AKAK_Km_Mn	AKAK_s_Mn_z.z	For selected channel m calibration gas value of Range Mn is responded

**12.4.5. AMBU: Upper and lower range switchover values for auto range**

Command	Response	Description
_AMBU_Km	_AMBU_s_M1_w.w_W.W _M2_x.x_X.X _M3_y.y_Y.Y _M4_z.z_Z.Z	Lower and upper range switchover value of auto range are responded for channel m
_AMBU_Km_Mn	_AMBU_s_Mn_w.w_W.W	Lower and upper range switchover value of auto range are responded for channel m range n

12.4.6. **ASTZ:** Normal device status

Command	Response	Description
_ASTZ_K0	_ASTZ_s_K1_State1_State2_State3 _K2_State1_State2_State3 _K3_State1_State2_State3	Respond device status for all channels
_ASTZ_Km	_ASTZ_s_State1_State2_State3	Respond device status only for channel m

**Possible states:**

State 1	State 2	State 3
SREM: remote SMAN: manual	STBY: standby SPAU: pause SMGA: measuring gas SNGA: zero gas SEGA: end gas SATK SNGA: zero gas during auto cal SATK SEGA: end gas during auto cal	SARE: auto range on SARA: auto range off

12.4.7. **ASTF:** Error status

Command	Response	Description
_ASTF_K0	_ASTF_s_f1_f2_f3_..._f10	Current error numbers of all are responded

**Errors:**

1	Channel 1 Flow Failure	8	Channel 1 not calibrated
2	Channel 2 Flow Failure	9	Channel 2 not calibrated
3	Channel 3 Flow Failure	10	Channel 3 not calibrated
4	External Analog 1 Failure	11-13	Ch1...3: Low concentration warning
5	External Analog 2 Failure	14-16	Ch1...3: High concentration warning
6	Pressure Failure	17-19	Ch1...3: Temperature failure
7	Temperature Failure	20-22	Ch1...3: EPC Voltage failure

12.4.8. **AKEN:** Device identification

Command	Response	Description
_AKEN_K0	_AKEN_s_devicename	Device identification is responded
_AKEN_K1	_AKEN_s_model	Device model
_AKEN_K2	_AKEN_s_serialno	Device serial number
_AKEN_K3	_AKEN_s_samplepressure	Suggested input sample pressure

12.4.9. **ARMU:** Raw value

Command	Response	Description
_ARMU_K0	_ARMU_s_z.z_y.y_x.x_t	Raw value before linearization and offset-span-correction is responded for all channels t = Timestamp (1/10 sec) Raw value before linearization and offset-span-correction is responded for channel m t = Timestamp (1/10 sec)



12.4.10. **ATEM:** Temperatures

Command	Response	Description
_ATEM_K0	_ATEM_s_z.z	Device temperature in degrees Celsius is responded
_ATEM_Km	_ATEM_s_z.z	Detector temperature of channel m is returned in z.z

12.4.11. **ADRU:** Pressures/ Valve voltage

Command	Response	Description
_ADRU_K0	_ADRU_s_z.z	Pressure in is responded
_ADRU_Km	_ADRU_s_z.z	EPC voltage of channel m is returned in z.z

12.4.12. **ADUF:** Flows

Command	Response	Description
_ADUF_K0	_ADUF_s_z.z_y.y_x.x	Sample gas flow of all channels is responded
_ADUF_Km	_ADUF_s_z.z	Sample gas flow of channel m is responded

12.4.13. **AGRD:** Polynom coefficients

Command	Response	Description
_AGRD_Km_Mn	_AGRD_s_Mn_a0_a1_a2_a3_a4	Polynomial coefficients of channel m range Mn are responded

12.4.14. **AANG:** Deviation from zero point after autocalibration

Command	Response	Description
_AANG_Km	_AANG_s_M1_z.z_da_dr _M2_z.z_da_dr _M3_z.z_da_dr _M4_z.z_da_dr	Verifying deviations from zero point after auto calibration. Values: measured value (z.z), absolute dev (da), relative dev (dr)

12.4.15. **AAEG:** Deviation from end point after autocalibration

Command	Response	Description
_AAEG_Km	_AANG_s_M1_z.z_da_dr _M2_z.z_da_dr _M3_z.z_da_dr _M4_z.z_da_dr	Verifying deviation from end point after auto calibration Values: measured value (z.z), absolute dev (da), relative dev (dr)

12.4.16. **AFDA:** Purge and Autocalibration times

Command	Response	Description
_AFDA_Km_SATK	_AFDA_s_z_y_x_w	Auto calibration times of channel m: z: Purge time y: Calibration time x: Total calibration time w: Verify time (z, y, x, w in seconds)
_AFDA_K0_SSPL	_AFDA_s_z	Purge time will be responded

12.4.17. **APAR:** Request Autocalibration tolerance values

Command	Response	Description
_APAR_Km_SATK	_APAR_s_z.z_y.y_x.x_w.w	Autocalibration tolerance value (%): z.z: Range 1 y.y: Range 2 x.x: Range 3 w.w: Range 4

12.4.18. **AKAL:** Deviations from calibration

Command	Response	Description
_AKAL_Km_	_AKAL_s_M1_z.z_y.y_x.x_w.w _M2_z.z_y.y_x.x_w.w _M3_z.z_y.y_x.x_w.w _M4_z.z_y.y_x.x_w.w	Deviation: z.z: Zero gas relative last calibration y.y: Zero gas factory calibration. x.x: Span gas relative last calibration. w.w: Span gas factory calibration

12.4.19. **ASYZ:** Respond System Time

Command	Response	Description
_ASYZ_K0_	_ASYZ_s_yymmdd_hhmmss	System time: yymmdd: year, month, day (each 2 characters wide, no spaces) hhmmss: hour, minute, second (each 2 characters wide, no spaces)

12.4.20. **AT90:** Respond Lowpass filter time

Command	Response	Description
_AT90_K0_	_AT90_s_t	Respond low pass filter time t=filter time in seconds

12.4.21. **ADAL:** Diagnostic alarm limits

Command	Response	Description
_ADAL_K0	_ADAL_s_a1.min_a1.max_... _a16.min_a16.max	All alarms limits are responded
_ADAL_K0_x	_ADAL_s_x.min_x.max	Alarm limits of x

**Alarm Limits:**

1	Sample gas flow channel 1	7	Temperature
2	Sample gas flow channel 2	8	Sample concentration channel 1
3	Sample gas flow channel 3	9	Sample concentration channel 2
4	External input 1	10	Sample concentration channel 3
5	External input 2	11-13	Temperature channel 1...3
6	Barometric -Pressure	14-16	EPC voltage channel 1...3

12.4.22. **ATCP:** Query TCP/IP settings

Command	Response	Description
_ATCP_K0	_ADAL_s_zzz.zzz.zzz.zzz _yyy.yyy.yyy.yyy _xxxx	zzz: TCP/IP Address yyy: TCP/IP subnet mask xxxx: TCP/IP port

12.4.23. **AVER:** Query Software version

Command	Response	Description
_AVER_K0	_AVER_s_3MAIN_z_3USER_y_OS MSR_x	z: Main version x.xxx.b_dd.mm.yyyy y: User version x.xxx.b_dd.mm.yyyy x: OSMSR version x.xxx_dd.mm.yyyy

12.4.24. **AH2O:** Query H<sub>2</sub>O correction parameter

Command	Response	Description
_AH2O_Km	_AH2O_s_z.z_y.y_x.x	z.z: Dry – voltage of A in with no water present y.y: 1st order coefficient x.x.: 2nd order coefficient

12.4.25. **ACO2:** Query CO<sub>2</sub> correction parameter

Command	Response	Description
_ACO2_Km	_ACO2_s_z.z_y.y_x.x_w.w	z.z: Offset – voltage of A in with no CO <sub>2</sub> present y.y: Min A in – if A in is below this value no CO <sub>2</sub> correction will be done. x.x: 1st order coefficient w.w.: 2nd order coefficient

12.4.26. **AUDP:** Query UDP data streaming parameter

Command	Response	Description
_AUDP_K0	_AUDP_s_<UDPPort>_ <DataFrequency>_ [<Mode>] _ [<UDP_IP>]	Port: port for open the UDP connection DataFrequency: Frequency for transmit the data in Hz Mode: A: ASCII Mode UDP_IP: Alternative IP address for open the UDP connection when it should not use the IP of connected TCP/IP client

**12.5. Control commands****12.5.1. SRES: Reset**

Command	Response	Description
_SRES_K0	_SRES_s	Reset

**12.5.2. SPAU: Pause**

Command	Response	Description
_SPAU_K0	_SPAU_s	Pause mode

**12.5.3. STBY: Standby**

Command	Response	Description
_STBY_K0	_STBY_s	Standby mode for all channels
_STBY_Km	_STBY_s	Standby mode for channel m

**12.5.4. SNGA: Open valve for zero gas calibration**

Command	Response	Description
_SNGA_K0	_SNGA_s	Open all three zero gas valves
_SNGA_Km	_SNGA_s	Open valve for zero gas calibration of actual measuring range
_SNGA_Km_Mn	_SNGA_s	Open valve for zero gas calibration of range Mn

**12.5.5. SEGA: Open valve for end gas calibration**

Command	Response	Description
_SEGA_K0	_SEGA_s	Open all three end gas valves
_SEGA_Km	_SEGA_s	Open valve for end gas calibration of actual measuring range
_SEGA_Km_Mn	_SEGA_s	Open valve for end gas calibration of range Mn

**12.5.6. SSPL: Purge Analyzer with zero gas**

Command	Response	Description
_SSPL_K0	_SSPL_s	Open zero gas valve and purge all channels

**12.5.7. SATK: Start automatic calibration**

Command	Response	Description
_SATK_Km	_SATK_s	Start automatic calibration with selected range of channel m
_SATK_Km_Mn	_SATK_s	Start automatic calibration for channel m, Range n

**12.5.8. SEMB: Set measuring range**

Command	Response	Description
_SEMB_Km_Mn	_SEMB_s	Set measuring range Auto range will be disabled

12.5.9. **SARE:** Auto range on

Command	Response	Description
_SARE_K0	_SARE_s	Set auto range on for all channels
_SARE_Km	_SARE_s	Set auto range on for channel m

12.5.10. **SARA:** Auto range off

Command	Response	Description
_SARA_K0	_SARA_s	Set auto range off for all channels
_SARA_Km	_SARE_s	Set auto range off

12.5.11. **SREM:** Remote mode for AK-commands

Command	Response	Description
_SREM_K0	_SREM_s	Set device in remote mode

12.5.12. **SMAN:** Manual control to control device manually

Command	Response	Description
_SMAN_K0	_SMAN_s	Set device in manual mode

12.5.13. **SMGA:** Start measuring

Command	Response	Description
_SMGA_K0	_SMGA_s	Start measuring Open all sample valves
_SMGA_Km	_SMGA_s	Open sample valve of channel m

12.5.14. **SNKA:** Saves measured value as new offset.

Command	Response	Description
_SNKA_K0	_SNKA_s	Saves measured value of actual range for each channel as new offset if zero valve is opened
_SNKA_Km	_SNKA_s	Saves measured value of actual range as new offset if zero valve is opened

12.5.15. **SEKA:** Saves measured value as new span value

Command	Response	Description
_SEKA_K0	_SEKA_s	Saves new span values for each channel if span valve is opened
_SEKA_Km	_SEKA_s	Saves measured value of actual range as new span value if span valve is opened

12.5.16. **SUDP:** Start /Stop UDP data streaming

Command	Response	Description
_SUDP_K0_ON	_SUDP_s	Start Data streaming via the UDP channel. You need to configure the channel before with EUDP command
_SUDP_K0_OFF	_SUDP_s	Stop streaming via the UDP channel

**12.6. Settings**

12.6.1. **EKAK:** The four span gas concentration values are set

Command	Response	Description
_EKAK_Km_M1_w.w_M2_x.x_M3_y.y_M4_z.z	_EKAK_s	Set end gas values for channel m

12.6.2. **EMBE:** The four measuring range end values are set

Command	Response	Description
_EMBE_Km_M1_w.w_M2_x.x_M3_y.y_M4_z.z	_EMBE_s	Set range limits

12.6.3. **EMBU:** The upper and the lower range switchover for auto range are set

Command	Response	Description
_EMBU_Km_M1_w.w_W.W_M2_x.x_X.X_M3_y.y_Y.Y_M4_z.z_Z.Z	_EMBU_s	Set lower and upper range switchover limits

12.6.4. **EKEN:** Set new device identification and information

Command	Response	Description
_EKEN_K0_new device-name	_EKEN_s	Set new device identification Maximum length of device name is 40 characters

**NOTE:** To change device identification, you must first rename the device to “RESET”. Now a name up to 40 characters can be given.

**NOTE:** The device name must not have any blanks between characters, e.g. “CAI CLD” is not allowed. You can use underscores, e.g.. “CAI\_CLD”.

12.6.5. **EGRD:** Set polynom coefficients

Command	Response	Description
_EGRD_Km_Mn_a0_a1_a2_a3_a4	_EGRD_s	Set polynomial coefficients of range Mn on channel m

12.6.6. **EFDA:** Set autocalibration and purge times

Command	Response	Description
_EFDA_Km_SATK_z_y_x_w	_EFDA_s	Set auto cal. times for channel m: z: Purge time y: Calibration time x: Total calibration time w: Verify time (z, y, x, w in seconds)
_EFDA_K0_SSPL_z	_EFDA_s	Set analyzer purge time to z seconds

12.6.7. **EPAR:** Set autocalibration tolerance values

Command	Response	Description
_EPAR_Km_SATK_z.z_y.y_x.x_w.w	_EPAR_s	Autocalibration tolerance value (%): z.z= Range 1 y.y= Range 2 x.x= Range 3 w.w= Range 4

12.6.8. **ESYZ:** Set System Time

Command	Response	Description
_ESYZ_K0_yymmdd_hhmmss	_ESYA_s	Set system time: yymmdd: year, month, day (each 2 characters wide, no spaces) hhmmss: hour, minutes, seconds (each 2 characters, no spaces)

12.6.9. **ET90:** Set Lowpass Filter Time

Command	Response	Description
_ET90_K0_t	_ET90_s	Set lowpass filter time: t= filter time in seconds

12.6.10. **EDAL:** Diagnostic alarm limits

Command	Response	Description
_EDAL_K0_a1.min_a1.mas..._a12max	_EDAL_s	Set all alarm limits
_EDAL_K0_x_x.min_xmax	_EDAL_s	Set alarm limits of x

**Alarm Limits:**

1	Flow of channel 1	7	Temperature
2	Flow of channel 2	8	Sample concentration channel 1
3	Flow of channel 3	9	Sample concentration channel 2
4	External analog in 1	10	Sample concentration channel 3
5	External analog in 2	11-13	Temperature alarm limits channel 1...3
6	Pressure	14-16	EPC voltage alarm limits channel 1...3

12.6.11. **ETCP:** Set TCP/IP Parameters

Command	Response	Description
_ETCP_K0_zzz.zzz.zzz.zzz _yyy.yyy.yyy.yyy _xxxx	_EDAL_s	zzz= TCP/IP address yyy= TCP/IP subnet mask xxxx= TCP/IP port All changes take effect after next power on cycle

12.6.12. **EH2O** Set H<sub>2</sub>O correction parameters

Command	Response	Description
_EH2O_Km_z.z_y.y_x.x	_EH2O_s	z.z: dry y.y: 1st order coefficient x.x: 2nd order coefficient

12.6.13. **ECO2** Set CO<sub>2</sub> correction parameters

Command	Response	Description
_EH2O_Km_z.z_y.y_x.x	_EH2O_s	z.z: dry y.y: 1st order coefficient x.x: 2nd order coefficient

12.6.14. **EUDP** Set UDP Data streaming parameters

Command	Response	Description
_EUDP_K0_<UDPPort>_<DataFrequency>_[<Mode>]_[<UDP_IP>]	_EUDP_s	<p>Configure an UDP channel for data streaming of the measuring values via Ethernet UDP. Port: port for open the UDP connection</p> <p>DataFrequency: Frequency for transmit the data in Hz</p> <p>Mode: A: ASCII Mode (optional) UDP_IP: Alternative IP address for open the UDP connection when it should not use the IP of connected TCP/IP client (optional)</p>

## 12.6.15. Format of the streaming Data via UDP:

ASCII Mode:

The measuring values will be sent with ASCII signs. The format is:

<Sequence number>\_x.x\_y.y\_z.z

The sequence number will be incremented with every data packet, which is sent.

The measuring values x.x, y.y and z.z will be sent like in AKON K0 telegram

12.7. **Abbreviations used**

Km	: K' + channel Number (→K1....K3)
Mn	: Measuring range number
M1 .. M4	: Measuring Range 1 .. 4
w.w..zz	: Numerical value
W.W...Z.Z	: Numerical value
T	: Numeric integer value
x	: Number
a0 .. a4	: Polynomial coefficients
s	: Status



### 13. Appendix Electrical Block Diagram

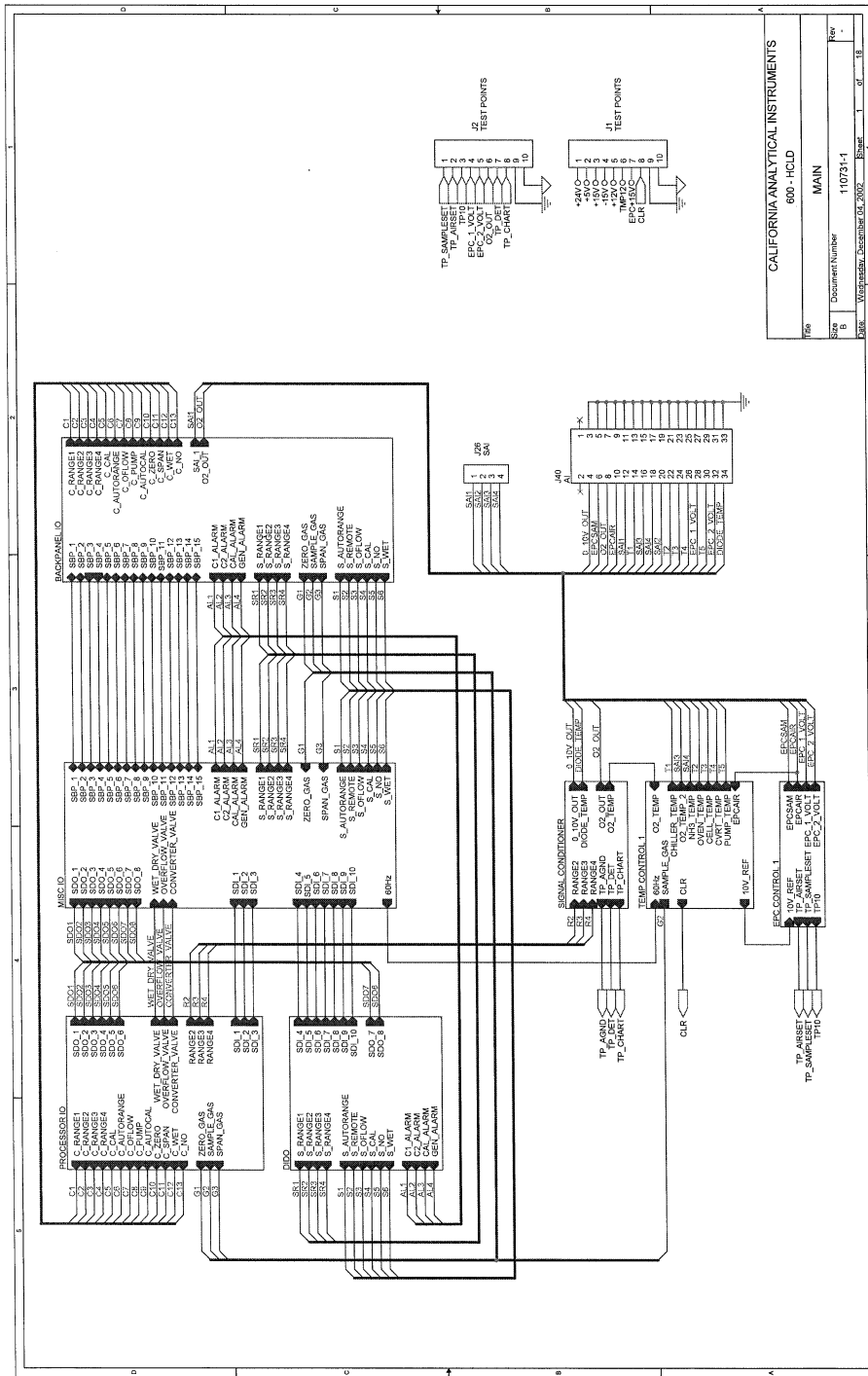

Doc No	Document Number	Rev
600-HCLD	110731-1	1
CALIFORNIA ANALYTICAL INSTRUMENTS		
600-HCLD		
MAIN		
Doc	110731-1	Rev
Issue	1	01-18

---

**TABLE OF CONTENTS**

**ADDENDUM**

**STARTING AFTER JUNE, 2007**

<u>Section</u>	<u>Title</u>	<u>Page</u>
<b>1.0.</b>	<b>Introduction</b> -----	
<b>2.0.</b>	<b>Operation of Measurement Keys</b> -----	
	2.1 Over Range-----	
	2.2 Diagnostics -----	
	2.3 Zero-----	
	2.4 Span-----	
	2.5 Range Limits-----	
	2.6 Span Values -----	
	2.7 Outputs -----	
<b>3.0</b>	<b>New Functions</b> -----	
	3.1 Auto Start Up -----	
	3.2 Alarms On/Off -----	
	3.3 Offset & Gain -----	
	3.4 Calibrate The Analog Outputs -----	
	3.5 Save Data Archiving Time-----	
	TABLE A-----	
	3.6 User Digital Outputs -----	
	TABLE B-----	
	TABLE C-----	
<b>4.0.</b>	<b>Changes To Existing Functions</b> -----	
	4.1 Saved or Outside Limits -----	
	4.2 Calibration Deviations-----	
	4.3 Flow Zero or Span Gas-----	
	4.4 Reset Calibration Values -----	
	TABLE D.....	

## 13.5 Starting With Serial Number U06081

### 1.0 INTRODUCTION

The Model 600 NDIR Series of instruments shipped after June, 2007 have several new Hardware and Software features.

The Hardware includes the use of a new memory system, isolation of the analog output signals and 15 relays that are used to buffer the many new digital output signals that are now available. **SEE TABLE D**

The available digital signals consist of a SERVICE group, which can be used to externally monitor a number of conditions for preventative maintenance and diagnostics.

A second STATUS group, is provided to define the operation of the instrument such as Spanning, Zeroing, Calibrating and the current Range (1, 2, 3, 4, AUTO)

Many of the various signals are duplicated because an NDIR instrument can consist of up to three different channels.

The Software includes modifications to existing functions, changes to the Measurement screen, additional Short-Cut Keys and several New Functions that are listed as follows:

- **MEASUREMENT**

<b>Over Range</b>	<b>888888</b>
<b>Diagnostics</b>	<b>F3</b>
<b>Zero</b>	<b>F5</b>
<b>Span</b>	<b>F6</b>
<b>Range Limits</b>	<b>F8</b>
<b>Span Values</b>	<b>F9</b>
<b>Outputs</b>	<b>F10</b>

Note: The operator can use these Short-Cut Keys or continue to use existing procedures.

- **NEW FUNCTIONS**

<b>Auto Startup</b>	<b>F5, F7, F7</b>
<b>ALARMS</b>	<b>F5, F7, (Use F6 to toggle ON/OFF)</b>
<b>Offsets&amp; Gains</b>	<b>F4, F3, F5</b>
<b>D/A Calibration</b>	<b>F5, F7, F8</b>
<b>Save Data Archiving Time</b>	<b>F5, F7, F1, F5 (ENTER to change record time)</b>
<b>User Digital Outputs</b>	<b>F5, F9</b>

- **Modifications**

<b>Saved/Not good</b>	<b>F4, F2, F1 or F2 (To flow Zero or Span Gas)</b>
<b>Re-Set Calibration Values</b>	<b>F4, F5</b>

## 2.0 OPERATION OF MEASUREMENT KEYS

Note: USE the F1 & F2 Keys to view the complete list of menu items, from the MEASUREMENT screen

### 2.1 Over Range 888888

In the MEASUREMENT mode only, any value that exceeds the “range” by more than 10% will be displayed as 888888.

### 2.2 Diagnostics Use F3 to toggle between MEASUREMENT and DIAGNOSTIC

**2.3 Zero:** From the MEASUREMENT screen, select the required channel and range then press **F5**.

Note: For instruments with Zero Solenoid(s) select Calibration by Valves. (**Main, F5, F2, F4**)

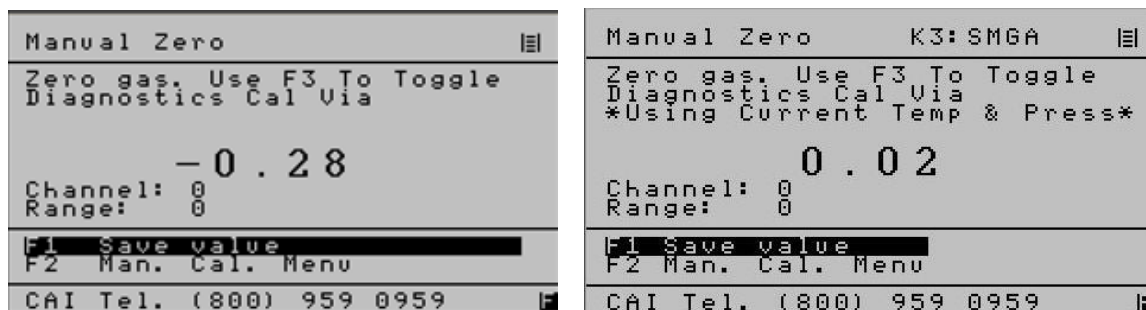

### 2 Versions

Zero Gas will be enabled and the observed results can be used to evaluate instrument performance

Press **F3** to toggle to the Diagnostic screen for additional information

Press **F1** to save the value and complete a ZERO calibration for this channel and range.

Press **MAIN, F1** to return to the MEASUREMENT screen to select other channels and ranges and repeat the process or press **F2** to return to the Manual Calibration screen

**2.4 Span:** From the MEASUREMENT screen, select the required Channel and Range then press **F6**.

Note: For instruments with Span Solenoid(s) select Calibration by Valves (**Main, F5, F2, and F4**).

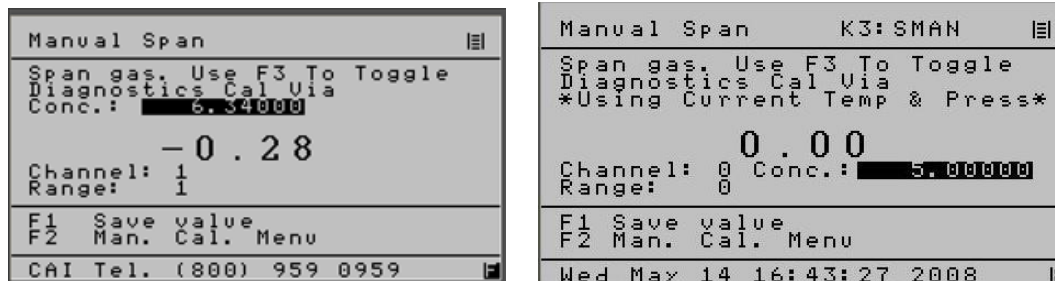

2 Versions

Span Gas for Channel1 and Range 1 will be enabled and the observed results can be used to evaluate instrument performance.

Press **F3** to toggle to the Diagnostic screen for additional information

Press **F1** to save the new value and complete the SPAN calibration for this Channel and Range.

Note: The span gas value used for this channel and range is highlighted and can be changed if necessary. Use the Enter key and the numeric keys as required.

Press **MAIN, F1** to return to the MEASUREMENT screen to select other Channels and Ranges and repeat the process or **F2** to return to the Manual Calibration screen.

## 2.5 Range Limits: (F8) From the MEASUREMENT screen;

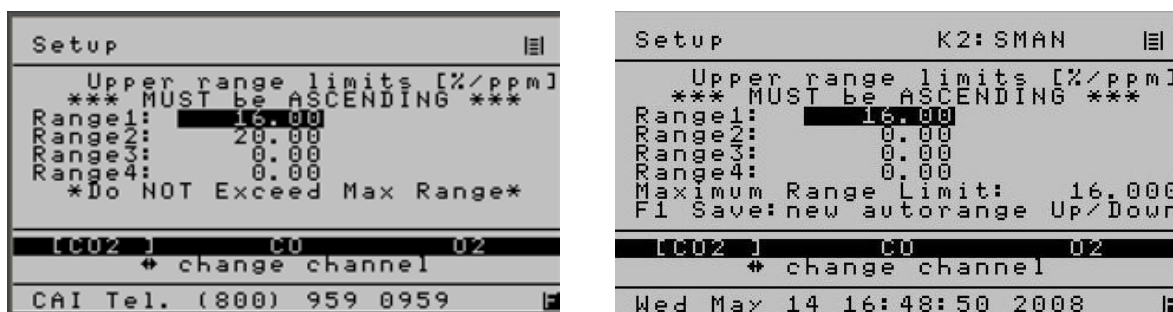

2 Versions.

The Channels and Ranges are factory defined and application specific. Consult California Analytical if any changes are required.

Use the ← → keys to observe the other Channels.

## 2.6 Span Values: F9 From the MEASUREMENT screen

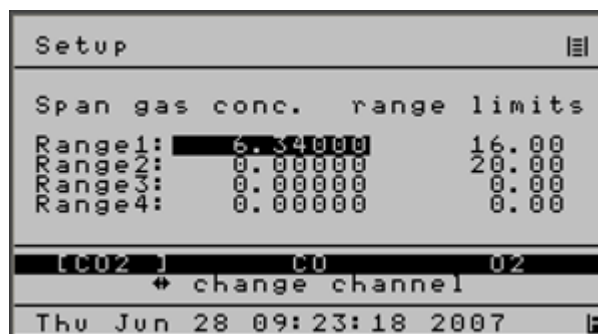

Use the ← → keys to select the desired Channel and the ↑ to select the Range  
 Note: The span gas value used for this channel and range is highlighted and can be changed if necessary.

Use the **Enter** key and the **NUMERIC** keys as required.

## 2.7 Outputs: F10 From the MEASUREMENT screen

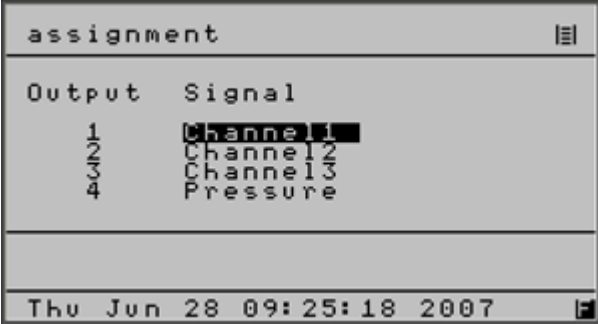

Output	Signal
1	Channel 1
2	Channel 2
3	Channel 3
4	Pressure

Thu Jun 28 09:25:18 2007

Use this screen to define the signals and their location that will be monitored by a remote reordering device.

Use the  $\updownarrow$  to select the desired Output. Press Enter to select  
Use the  $\updownarrow$  to select the desired Signal. Press Enter to select

Use this screen to define the signals and their location that will be monitored by a remote reordering device.

**SEE TABLE D**

### 3.0 NEW FUNCTIONS

#### 3.1 Auto Start Up: (Main, F5, F7, F7)

Auto Startup				
.Auto Startup	:	On		
.Wait for [min]	:	1		
.Access Level	:	1		
.Remote/Manual	:	Manual		
		Ch1	Ch2	Ch3
.Calibrations	:	1	1	1
.Startrange	:	1	1	1
MAIN SAVE				
BACK SAVE				
Mon Jan 01 01:40:07 2001				

All key analyzer parameters are stored in a secure memory location and retained when power is removed

In the event of an unexpected power failure it may be desirable to change some parameters until an operator can resume control.

This screen may be used to establish several desirable special instrument start-up parameters that define how the analyzer recovers from loss of AC power

When enabled this screen will define the following:

**Wait:** The time delay in minutes before proceeding. If **zero** is selected the instrument will not start until all temperature warnings are cleared

**Calibrations:** The number of attempts to complete a successful calibration as required in the operator defined Deviation Tables.  
If calibration is not successful the instrument will continue reporting results using the last completed calibration.  
The analyzer can be configured use the previous calibration by selecting zero Calibrations.

**Starting Range:** When all defined actions are completed the analyzer will return to the Measurement Screen and to the range specified.

**Access Level:** The user level at Start Up

**Remote/Manual:** Put the analyzer in either "Remote" or "Manual" at Start Up



### 3.2 Alarms On/Off: (Main, F5, F7)

All key analyzer parameters are stored in a secure memory location and retained when power is removed. In the event of an unexpected power failure it may be desirable to change some parameters until an operator can resume control.

This screen may be used to establish several desirable special instrument start-up parameters that define how the analyzer recovers from loss of AC power.

When enabled this screen will define the following...

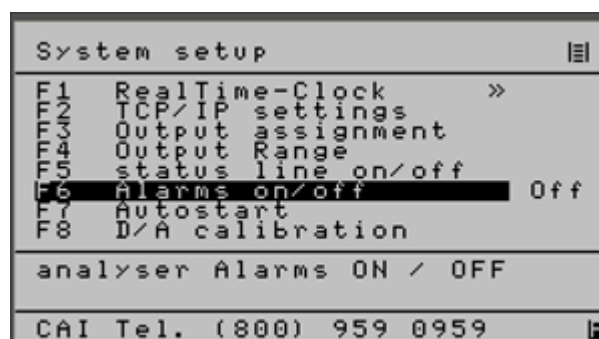

Use **F6** to toggle ON/OFF

The instrument has an extensive library of error messages that will aid in the identification of various anomalous events and are displayed at the bottom of the screen. These messages will assist in Diagnostics and indicating the need for preventative maintenance

This screen provides an **option** to disable these messages during initial start-up or as may be desired for a particular application.

### 3.3 Offset & Gain (Main, F4, F3, F5)

Offset and Gain		
Zero/ Span	applied	correction
	Offset	Gain
Range1:	0.00	1.00
Range2:	0.00	1.00
Range3:	0.00	1.00
Range4:	0.00	1.00
[CO2 ]	CO	O2
	← to select channel	
CAI Tel. (800) 959 0959		

This screen can be used to provide an additional means to display calibration deviations.

Use ← → keys to change channel.

The OFFSET is the value stored during zero calibration.

The GAIN is the value stored during span gas calibration using the operator defined calibration gas.

An increasing or decreasing change to the OFFSET or GAIN when used in conjunction with “Deviations” will provide insight to both short and long term changes to system performance

### 3.4 Calibrate The Analog Outputs: Main, F5, F7, F8 D/A Calibration Main, F5, F7, F3 Output Assignment

- **Overview**

The 600 NDIR Series of instruments are designed to provide analog outputs that can be configured as 0-1 VDC, 0-5 VDC, 0-10 VDC, 4-20 mA, or 0-20 mA.

With this version the outputs can also be configured to include an additional 1.0 volt and 5.0 volt output and a **calibration** capability.

The outputs can be calibrated to exactly match the results obtained on a PLC, Recorder, Data Logger or other remote recording device that may be connected to the analyzer.

The operator will first select the **OUTPUT ASSIGNMENT (Main, F5, F7, F3)** screen and choose the output that is to be calibrated. By selecting “calibrate” as the output all outputs of interest may be selected. When calibration is completed, the operator will return the outputs to their original assignment

The **D-A CALIBRATION** screen will then be used to complete the calibration procedure.

Output	Offset	Gain
1	1.8000	0.7000
2	1.8000	0.7000
3	1.8000	0.7000
4	1.8000	0.7000

\*\*Set Output-F3-Calibrate\*\*

MAIN / BACK SAVE  
FS F1: 0% F5: 100%

This screen provides a section that is used to record the zero signal corrections (zero offset) and a second area to record the 100% signal corrections (Gain) for each of the four output signals that may be defined to develop a voltage or current signal..

Since this is a Digital to Analog conversion, the calibration will require the completion of a simple “trial and error” procedure. The operator will observe the results of a “zero” or “span” (Gain) signal generated by the analyzer to the remote recording device and select a correction factor. The operator will save this value and then observe the results on attached the remote recording device.

The process of selection and saving for “zero” and “span” will be repeated until a satisfactory calibration is achieved. For 0-1VDC, 0-5VDC, 0-10VDC and a 0-20 mA outputs the Offset and Gain values are independent and do not interact. With the 4-20 ma output, the Offset “zero” and Gain “span” values interact and may require a few more trials.

The following is a table of typical values:

OUTPUT	OFFSET	GAIN
0-20 ma	0.000	0.927
4-20 ma	1.820	0.740
0-1 V	1.300	0.820
0-5 V	1.100	0.820
0-10 V	1.050	0.820

- **Procedure**

3.4.1 From the Main Menu press **F5, F7, F3**, to obtain following screen:

Output	Signal	mA
1	Channel1	
2	Channel2	
3	Channel3	
4	Flow1	

**Main, F5, F7, F3**

3.4.2 Use the  $\uparrow$  to highlight the outputs that require calibration.

3.4.3 Press enter to provide access to all the menu of signals that are available. (Real Time). Channel 1, Channel 2, Calibration, Sample pressure, etc.)

3.4.4 Select Calibration and press **ENTER** to complete the selection

Output	Signal
1	Calibrate
2	Channel2
3	Channel3
4	Flow1

CAI Tel. (800) 959 0959

Note: Any or all of the four outputs can be selected for calibration  
This screen will not be used again until calibration has been completed.

3.4.5 Press **BACK** to return to the SYSTEM SETUP screen (**F5, F7** from the main menu)

3.4.6 Press **F8** to obtain the following screen:

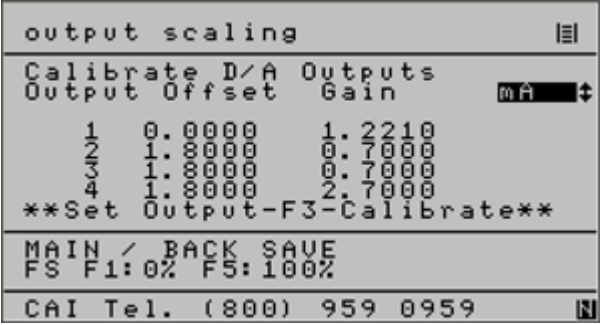

```
output scaling
-----
Calibrate D/A Outputs
Output Offset Gain
1 0.0000 1.2210
2 1.8000 0.7000
3 1.8000 0.7000
4 1.8000 2.7000
**Set Output-F3-Calibrate**
MAIN / BACK SAVE
FS F1: 0% F5: 100%
CAI Tel. (800) 959 0959
```

**MAIN, F5, F7, F8**

3.4.7 Use the  $\uparrow$  to select the desired output press **ENTER**

3.4.8 Press **F1** to select a ZERO signal and observe the results on the remote device

3.4.9 Change the offset value press **BACK** to save the new value.

3.4.10 Press **F8** to return to the D-A Calibration screen and note the results on the remote device.

3.4.11 Repeat steps 3.4.8 thru 3.4.10 until a satisfactory ZERO calibration is achieved.

3.4.12 Complete steps 3.4.8 thru 3.4.10 for each of the remaining outputs that require calibration.

3.4.13 Press **F5** to produce a full scale (100%) signal

3.4.14 Use the arrow keys to position the cursor at the require GAIN value

3.4.15 Observe the results on the remote device and make a correction to the GAIN value for the output of interest. Press **BACK** to save this new value

3.4.16 Press **F8** to return to the D-A calibration screen

3.4.17 Observe the results on the remote device and repeat steps change the GAIN value by repeating steps 3.4.14 thru 3.4.16 as needed for each output.

3.4.18 Return to the OUTPUT Assignment screen **F5, F7, F3** from the main menu and change the output signals from CALIBRATE to their original values as defined in step 3.4.1.

### 3.5 Save Data Archiving Time (F5, F7, F1, F5)

Archive Time is the Time in seconds between each set of data points. If “zero” no data is stored in the SEC data files. The SEC data files are in .CSV format for direct import into Excel. CAI can provide the tools necessary to download these files.

Setup RTC	
F1	Set time
F2	Set autocalibration time
F3	Select calibration range
F4	Autocalibration on/off
F5	Save Data Archiving Time
	Archive Time(secs) <b>10</b>
F10	Show time
Archive Interval	
0 = Off F5:SAVE	
CAI Tel. (800) 959 0959	

Use ENTER to change recording time

**SEE TABLE A**

---

**TABLE A****600 SERIES NDIR DATA ARCHIVE FILES**

Time,  
Date,  
Month,  
Year,  
Error Index,  
TimeStamp,  
Pressure,  
Temperature,

Name,  
Concentration,  
Detector Volts,  
Range,  
Auto / Manual,  
Span Value,  
Offset,  
Gain,  
Sample Pressure,  
Sample Flow,  
Sample EPC Volts,  
Detector Temperature,  
Meas Mode,  
Local / Remote,

If 2 Channel this data is added

Name,  
Concentration,  
Detector Volts,  
Range,  
Auto / Manual,  
Span Value,  
Offset,  
Gain,  
Sample Pressure,  
Sample Flow,  
Sample EPC Volts,  
Detector Temperature,  
Meas Mode,  
Local / Remote,

**TABLE A (cont)**

**600 SERIES NDIR DATA ARCHIVE FILES**

If 3 channel this data is added

Name,  
Concentration,  
Detector Volts,  
Range,  
Auto / Manual,  
Span Value,  
Offset,  
Gain,  
Sample Pressure,  
Sample Flow,  
Sample EPC Volts,  
Detector Temperature,  
Meas Mode,  
Local / Remote,



### 3.6 User Digital Outputs

- **Overview**

The 600 NDIR Series of instruments have 15 solid state, optically coupled, isolated relays that can be programmed by the operator to indicate the status of numerous signals.

The available digital signals consist of a SERVICE Group that can be used to externally monitor a number of conditions to aid in preventative maintenance and diagnostics. **SEE TABLE B & D**

A second STATUS group is provided and is used to define the operation of the instrument such as Spanning, Zeroing, Calibrating, and the current Range (1, 2, 3, 4 AUTO) etc. **SEE TABLE C & D**

The individual output signals can be operator selected and set to a **HOLD** or **CLEAR** mode.

In the **HOLD** mode an activated signal is retained until the operator returns to the **Digital Output Screen** and selects the appropriate output signal and performs a manual CLEAR. After performing a Clear Operation, the operator must press **F2** again to put the outputs back onto **HOLD** mode.

```

User DO I           K2: STBY  |  |
-----|-----|-----|
1      Off
2      Off
3      Off
4      Off          *****
5      Off          *Set Unused *
6      Off          *Channels Off*
7      Off          *****
F2     Hold / Clear  Hold
-----|-----|-----|
F1 8 to 15 DO's
MAIN/BACK to SAVE
    
```

In the **Clear** Mode the signal will automatically change when the microprocessor detects that the noted condition no longer exists.

```

User DO II          K2: SMAN  |  |
-----|-----|-----|
8      Off
9      Off
10     Off
11     Off          *****
12     Off          *Set Unused *
13     Off          *Channels Off*
14     Off          *****
15     Off
-----|-----|-----|
F1 1 to 7 DO's
MAIN/BACK to SAVE
Check Ch1: Temp.
    
```

The operator can select from the following the desired **SERVICE** or **STATUS** groups that are to be digitally monitored.

**TABLE B**

<b>Index</b>	<b>Service Group</b>	<b>User DO Screen Display</b>
0		
1	Flow 1 Failure	F1
2	Flow 2 Failure	F2
3	Flow 3 Failure	F3
4	Extern Analog 1 Failure	E1
5	Extern Analog 2 Failure	E2
6	Pressure Failure	P
7	Temperature Failure	T
8	Channel 1 is not calibrated	1NC
9	Channel 2 is not calibrated	2NC
10	Channel 3 is not calibrated	3NC
11	Ch1: Low conc. Warning	1LoC
12	Ch2: Low conc. Warning	2LoC
13	Ch3: Low conc. Warning	3LoC
14	Ch1: High conc. Warning	1HiC
15	Ch2: High conc. Warning	2HiC
16	Ch3: High conc. Warning	3HiC
17	Ch1: Temperature!	1DT
18	Ch2: Temperature!	2DT
19	Ch3: Temperature!	3DT
20	Ch1: EPC failure	1EV
21	Ch2: EPC failure	2EV
22	Ch3: EPC failure	3EV
23	Ch1: Range overflow	1OR
24	Ch2: Range overflow	2OR
25	Ch3: Range overflow	3OR
26	Ch1: ADC Range Overflow	1AU
27	Ch2: ADC Range Overflow	2AU
28	Ch3: ADC Range Overflow	3AU
29	Ch1: ADC Range Underflow	1AO
30	Ch2: ADC Range Underflow	2AO
31	Ch3: ADC Range Underflow	3AO
32	dummy text for RTC	Off
33	<b>General Alarm</b>	<b>G</b>
35	<b>1 Cal Alarm</b>	<b>1CA</b>
36	<b>2 Cal Alarm</b>	<b>2CA</b>
37	<b>3 Cal Alarm</b>	<b>3CA</b>
34	<b>In Remote</b>	<b>R</b>

**TABLE C**

<b>Index</b>	<b><u>STATUS GROUP</u></b>	<b>User DO Screen Display</b>
38	1 AutoRange	1AR
39	1 Range 1	1R1
40	1 Range 2	1R2
41	1 Range 3	1R3
42	1 Range 4	1R4
43	1 In Calibrate	1C
44	1 In Zero	1Z
45	1 In Span	1S
46	1 In Sample	1Sa
47	2 Auto Range	2AR
48	2 Range 1	2R1
49	2 Range 2	2R2
50	2 Range 3	2R3
51	2 Range 4	2R4
52	2 In Calibrate	2C
53	2 In Zero	2Z
54	2 In Span	2S
55	2 In Sample	2Sa
56	3 Auto Range	3AR
57	3 Range 1	3R1
58	3 Range 2	3R2
59	3 Range 3	3R3
60	3 Range 4	3R4
61	3 In Calibrate	3C
62	3 In Zero	3Z
63	3 In Span	3S
64	3 In Sample	3Sa

Typical Relay

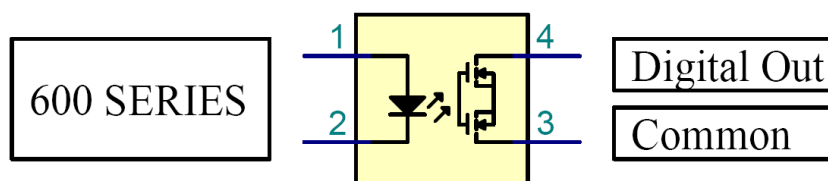

These contacts (3, 4) will drive continuously up to 500 MA using a customer voltage supply that does not to exceed 60 VDC.

- **Operation**

Use **(Main, F5, F9)** to select the first eight outputs

Use the  $\uparrow$  to select the desired output

Press ENTER and use  $\uparrow$  to select desired item

Press ENTER to save selection

NOTE: The 600 NDIR has 14 user selectable isolated digital outputs from the list of 64 in **TABLE B & C**

```

User DO I          K2: STBY  |
-----|-----
1  Off
2  Off
3  Off             *****
4  Off             *Set Unused *
5  Off             *Channels Off*
6  Off             *****
7  Off
F2 Hold / Clear   Hold
-----|-----
F1 8 to 15 DO's
MAIN/BACK to SAVE
  
```

Press **F1** to observe the remaining seven outputs  
Program as desired per the above

```

User DO II        K2: SMAN  |
-----|-----
8  Off
9  Off
10 Off
11 Off            *****
12 Off            *Set Unused *
13 Off            *Channels Off*
14 Off            *****
15 Off
-----|-----
F1 1 to 7 DO's
MAIN/BACK to SAVE
-----|-----
Check Ch1: Temp.
  
```

## 4.0 CHANGES TO EXISTING FUNCTIONS

### 4.1 Saved or Outside Limits

During Manual Calibration the following screens will be displayed to indicate the instruments response to the value of the zero or span gas using the amount that the operator defined in the deviation table.

Manual Zero K1:SMAN	Manual Span K2:SARE
Zero gas. Use F3 To Toggle Diagnostics Cal Via *Using Current Temp & Press* ***Saved Current*** 0.00	Span gas. Use F3 To Toggle Diagnostics Cal Via *Using Current Temp & Press* Outside Deviation Limits 0.02
Channel: 0 Range: 0	Channel: 0 Conc.: 5.00000 Range: 0
F1 Save value F2 Man. Cal. Menu	F1 Save value F2 Man. Cal. Menu
Wed May 14 16:42:09 2008	CAI Tel. (800) 959 0959

The Above is shown using Zero and Span Cal

From Measurement use: **F5 “zero” or F6 “span”**  
From Main Menu use: **F4, F2, F1 “zero” or F2 “span”**

#### 4.2 Calibration Deviations.

MAIN, F5, F2, F2 Deviations, F3 Measuring Deviations.

Deviations[%]		
	absolute	relative
Range 1:	10.00	10.00
Range 2:	10.00	10.00
Range 3:	10.00	10.00
Range 4:	10.00	10.00

Enter deviations for channel : 1

CAI Tel. (800) 959 0959

Measuring deviation[%]	
Range 1:	1.00
Range 2:	1.00
Range 3:	1.00
Range 4:	1.00

Enter deviations for channel : 1

Sun Jan 01 00:11:48 2003

Note: These screens are used by the operator to define the maximum acceptable limits of the Zero and Span gas for both Manual and Automatic Calibrating.

#### 4.3 Flow Zero or Span

Some analyzers have the above and the ability to flow Zero and Span Gas.

Manual calib		K1: SNGA
F1	Cal zero	0.02
F2	Cal span	ZERO
F3	Toggle zero	
F4	Toggle span	
F5	Measurements	
F6 Range Up ** F7 Range Down		
[CO2]	CO	O2
R1-16.00	AR1-100.0	R1-25.00
Wed May 14 16:45:58 2008		

Manual calib		K1: SARA
F1	Cal zero	0.01
F2	Cal span	SPAN
F3	Toggle zero	
F4	Toggle span	
F5	Measurements	
F6 Range Up ** F7 Range Down		
[CO2]	CO	O2
R1-16.00	AR1-100.0	R1-25.00
Wed May 14 16:47:28 2008		

The above is shown using Zero/SPAN Gas

From Cal Screen use: **F2 or Main or Back**  
 From Main Menu use: **F4, F2**

4.4 Reset Calibration Values

When the re-set calibrations value function is used all recorded deviations will be set to zero

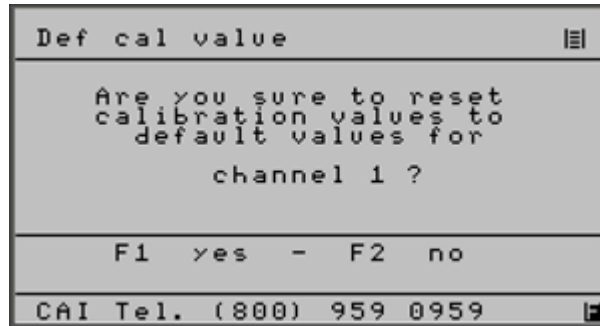

MAIN, F4, F5

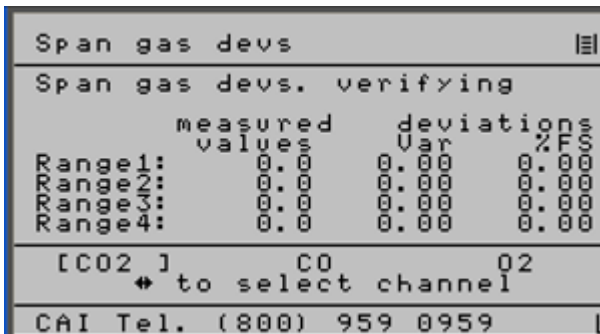

Main, F4 F3, F4

(Used to observe Auto Cal Results)

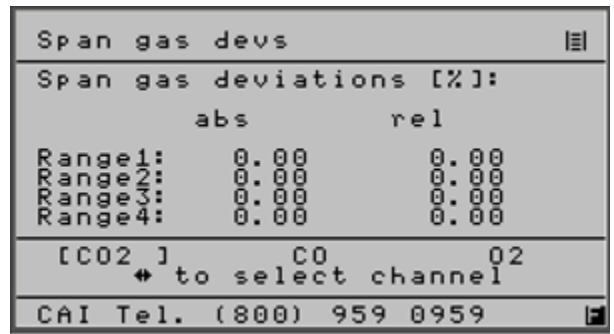

Main, F4, F3, F2

(Used to observe Manual Cal results)

The above are the new deviations after the operator elects to re-set the calibration values

## TABLE D

### 600 NDIR SERIES I/O CHART

#### 28 PIN MAIN CONNECTOR ASSIGNMENTS

AO = Analog Output, OC= Open Collector, SV = Solenoid Valve TTL = Transistor Logic

OPTO I/O	Signal Type	601 Analog	602 Analog	603 Analog	Levels
ALG 1		pin #	pin #	pin #	
COM	A Output	1 GND (Isolated analog)	1 GND (Isolated analog)	1 GND (Isolated analog)	<u>Isolated AI</u> 1v,5v,10v,mA
0	A Output	2 User Defined AO-1	2 User Defined AO-1	2 User Defined AO-1	
1	A Output	3 User Defined AO-2	3 User Defined AO-2	3 User Defined AO-2	
2	A Output	4 User Defined AO-3	4 User Defined AO-3	4 User Defined AO-3	
3	A Output	5 User Defined AO-4	5 User Defined AO-4	5 User Defined AO-4	
<b>DIG 1</b>		<b>Digital</b>	<b>Digital</b>	<b>Digital</b>	
COM	D Output	6 GND (Digital)	6 GND (Digital)	6 GND (Digital)	TTL-low true
0	D Output	7 Sense Auto Range	7 Sense Auto Range	7 Sense Auto Range	
1	D Output	8 Sense Range 1	8 Sense Range 1	8 Sense Range 1	
2	D Output	9 Sense Range 2	9 Sense Range 2	9 Sense Range 2	
3	D Output	10 Sense Range 3	10 Sense Range 3	10 Sense Range 3	
4	D Output	11 Sense Range 4	11 Sense Range 4	11 Sense Range 4	TTL-low true
5	D Input	12 Set Auto Range	12 Set Auto Range	12 Set Auto Range	
6	D Input	13 Control Range 1	13 Control Range 1	13 Control Range 1	
7	D Input	14 Control Range 2	14 Control Range 2	14 Control Range 2	
8	D Input	15 Control Range 3	15 Control Range 3	15 Control Range 3	
9	D Input	16 Control Range 4	16 Control Range 4	16 Control Range 4	
10	D Input	17 Auto Cal	17 Auto Cal	17 Auto Cal	
11	D Input	18 Calibrate	18 Calibrate	18 Calibrate	
12	D Input	19 Zero	19 Zero	19 Zero	
13	D Input	20 Span	20 Span	20 Span	
14	D Input	21 Sample	21 Sample	21 Sample	
15	SPARE				
<b>DIG 2</b>					
0	D Output	22 Zero Gas Flow	22 Zero Gas Flow	22 Zero Gas Flow	OC (24vdc if internal SV) OC (24vdc if internal SV) OC (24vdc if internal SV)
1	D Output	23 Span Gas Flow	23 Span Gas Flow	23 Span Gas Flow	
2	D Output	24 Sample Gas Flow	24 Sample Gas Flow	24 Sample Gas Flow	
3	D Output	25 Local/Remote	25 Local/Remote	25 Local/Remote	TTL-low true TTL-low true
4	D Output	26 Read Cal Mode	26 Read Cal Mode	26 Read Cal Mode	
5	D Output	27 Reserved	27 Reserved	27 Reserved	
6	D Output	28 Reserved	28 Reserved	28 Reserved	



**TABLE D**  
**600 NDIR SERIES I/O CHART**

**28 PIN AUXILLARY CONNECTOR ASSIGNMENTS**

OPTO I/O	Signal Type	601/602/603 Analog		LEVELS
ALG 1	Spare	pin #		
COM 4	A Input	1	GND (analog)	
5	A Input	2	External Analog 1	0-10V
6	A Input	3	External Analog 2	0-10V
7	A Output	4	<b>GND (Isolated analog)</b>	
	D Output	5	<b>Relay RTN 1</b>	<b>9,10,11,12 use RTN 1</b>
<b>DIG 3</b>	<b>Alarms</b>	<b>Digital</b>		<b>Alarms go OPEN when present</b> <b>Status go CLOSED when active</b>
COM 6	D Output	6	<b>Relay RTN 2</b>	<b>13,14,15,16 use RTN 2</b>
0	D Output	7	<b>Relay RTN 3</b>	<b>17,17,19,20 use RTN 3</b>
1	D Output	8	<b>Relay RTN 4</b>	<b>21,27,28 use RTN 4</b>
2	D Output	9	<b>User Defined NO Relay 1</b>	
3	D Output	10	<b>User Defined NO Relay 2</b>	
4	D Output	11	<b>User Defined NO Relay 3</b>	
5	D Output	12	<b>User Defined NO Relay 4</b>	
6	D Output	13	<b>User Defined NO Relay 5</b>	
7	D Output	14	<b>User Defined NO Relay 6</b>	
8	D Output	15	<b>User Defined NO Relay 7</b>	
9	D Output	16	<b>User Defined NO Relay 8</b>	
10	D Output	17	<b>User Defined NO Relay 9</b>	
11	D Output	18	<b>User Defined NO Relay 10</b>	
12	D Output	19	<b>User Defined NO Relay 11</b>	
13	D Output	20	<b>User Defined NO Relay 12</b>	
14	D Output	21	<b>User Defined NO Relay 13</b>	
15	D Output	22	<b>Reserved Do Not Connect</b>	
<b>DIG 2</b>				
7	D Input	23	Spare	
8	D Input	24	Spare	
9	D Input	25	Spare	
10	D Input	26	<b>Set Remote</b>	
11	D Output	27	<b>User Defined NO Relay 14</b>	
12	D Output	28	<b>User Defined NO Relay 15</b>	

---

**TABLE OF CONTENTS**
**ADDENDUM****STARTING AFTER JUNE, 2007**

<u>Section</u>	<u>Title</u>	<u>Page</u>
<b>1.0.</b>	<b>Introduction</b> -----	
<b>2.0.</b>	<b>Operation of Measurement Keys</b> -----	
	2.1 Over Range-----	
	2.2 Diagnostics -----	
	2.3 Zero-----	
	2.4 Span-----	
	2.5 Range Limits-----	
	2.6 Span Values -----	
	2.7 Outputs -----	
<b>3.0</b>	<b>New Functions</b> -----	
	3.1 Auto Start Up -----	
	3.2 Alarms On/Off -----	
	3.3 Offset & Gain -----	
	3.4 Calibrate The Analog Outputs -----	
	3.5 Save Data Archiving Time-----	
	TABLE A-----	
	3.6 User Digital Outputs -----	
	TABLE B-----	
	TABLE C-----	
<b>4.0.</b>	<b>Changes To Existing Functions</b> -----	
	4.1 Saved or Outside Limits -----	
	4.2 Calibration Deviations-----	
	4.3 Flow Zero or Span Gas-----	
	4.4 Reset Calibration Values -----	
	TABLE D.....	

## 13.5 Starting With Serial Number U06081

### 1.0 INTRODUCTION

The Model 600 NDIR Series of instruments shipped after June, 2007 have several new Hardware and Software features.

The Hardware includes the use of a new memory system, isolation of the analog output signals and 15 relays that are used to buffer the many new digital output signals that are now available. **SEE TABLE D**

The available digital signals consist of a SERVICE group, which can be used to externally monitor a number of conditions for preventative maintenance and diagnostics.

A second STATUS group, is provided to define the operation of the instrument such as Spanning, Zeroing, Calibrating and the current Range (1, 2, 3, 4, AUTO)

Many of the various signals are duplicated because an NDIR instrument can consist of up to three different channels.

The Software includes modifications to existing functions, changes to the Measurement screen, additional Short-Cut Keys and several New Functions that are listed as follows:

- **MEASUREMENT**

<b>Over Range</b>	<b>888888</b>
<b>Diagnostics</b>	<b>F3</b>
<b>Zero</b>	<b>F5</b>
<b>Span</b>	<b>F6</b>
<b>Range Limits</b>	<b>F8</b>
<b>Span Values</b>	<b>F9</b>
<b>Outputs</b>	<b>F10</b>

Note: The operator can use these Short-Cut Keys or continue to use existing procedures.

- **NEW FUNCTIONS**

<b>Auto Startup</b>	<b>F5, F7, F7</b>
<b>ALARMS</b>	<b>F5, F7, (Use F6 to toggle ON/OFF)</b>
<b>Offsets&amp; Gains</b>	<b>F4, F3, F5</b>
<b>D/A Calibration</b>	<b>F5, F7, F8</b>
<b>Save Data Archiving Time</b>	<b>F5, F7, F1, F5 (ENTER to change record time)</b>
<b>User Digital Outputs</b>	<b>F5, F9</b>

- **Modifications**

<b>Saved/Not good</b>	<b>F4, F2, F1 or F2 (To flow Zero or Span Gas)</b>
<b>Re-Set Calibration Values</b>	<b>F4, F5</b>

## 2.0 OPERATION OF MEASUREMENT KEYS

Note: USE the F1 & F2 Keys to view the complete list of menu items, from the MEASUREMENT screen

### 2.1 Over Range 888888

In the MEASUREMENT mode only, any value that exceeds the "range" by more than 10% will be displayed as 888888.

### 2.2 Diagnostics Use F3 to toggle between MEASUREMENT and DIAGNOSTIC

**2.3 Zero:** From the MEASUREMENT screen, select the required channel and range then press **F5**.

Note: For instruments with Zero Solenoid(s) select Calibration by Valves. (**Main, F5, F2, F4**)

Manual Zero	Manual Zero K3: SMGA
Zero gas. Use F3 To Toggle Diagnostics Cal Via	Zero gas. Use F3 To Toggle Diagnostics Cal Via *Using Current Temp & Press*
- 0 . 2 8	0 . 0 2
Channel: 0 Range: 0	Channel: 0 Range: 0
F1 Save value F2 Man. Cal. Menu	F1 Save value F2 Man. Cal. Menu
CAI Tel. (800) 959 0959	CAI Tel. (800) 959 0959

### 2 Versions

Zero Gas will be enabled and the observed results can be used to evaluate instrument performance

Press **F3** to toggle to the Diagnostic screen for additional information

Press **F1** to save the value and complete a ZERO calibration for this channel and range.

Press **MAIN, F1** to return to the MEASUREMENT screen to select other channels and ranges and repeat the process or press **F2** to return to the Manual Calibration screen

**2.4 Span:** From the MEASUREMENT screen, select the required Channel and Range then press **F6**.

Note: For instruments with Span Solenoid(s) select Calibration by Valves (**Main, F5, F2, and F4**).

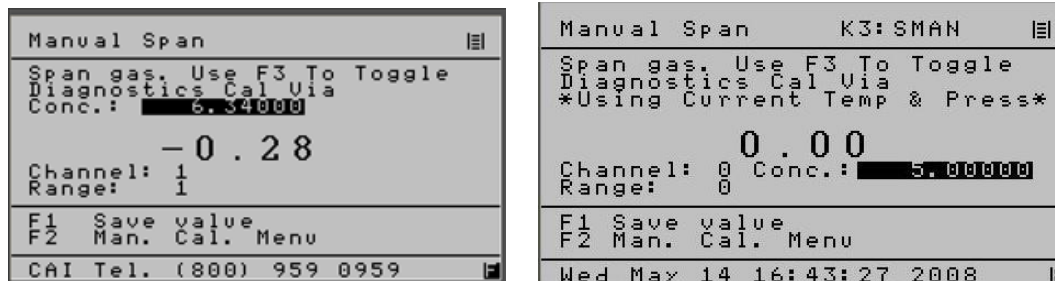

2 Versions

Span Gas for Channel1 and Range 1 will be enabled and the observed results can be used to evaluate instrument performance.

Press **F3** to toggle to the Diagnostic screen for additional information

Press **F1** to save the new value and complete the SPAN calibration for this Channel and Range.

Note: The span gas value used for this channel and range is highlighted and can be changed if necessary. Use the Enter key and the numeric keys as required.

Press **MAIN, F1** to return to the MEASUREMENT screen to select other Channels and Ranges and repeat the process or **F2** to return to the Manual Calibration screen.

## 2.5 Range Limits: (F8) From the MEASUREMENT screen;

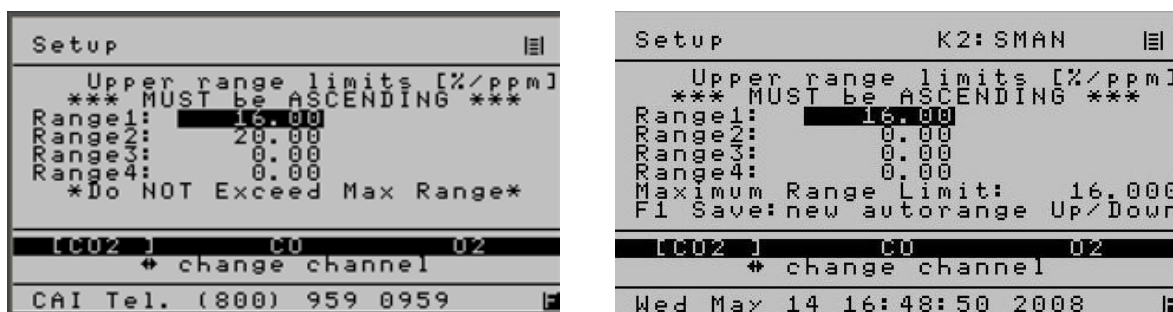

2 Versions.

The Channels and Ranges are factory defined and application specific. Consult California Analytical if any changes are required.

Use the ← → keys to observe the other Channels.

## 2.6 Span Values: F9 From the MEASUREMENT screen

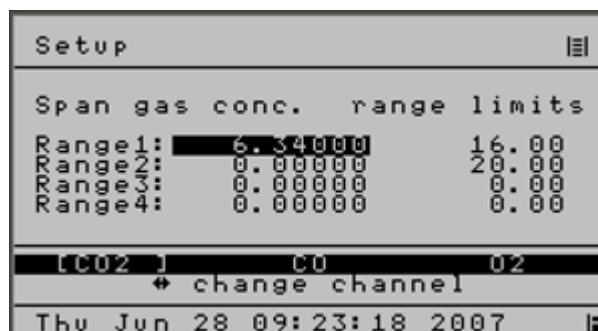

Use the ← → keys to select the desired Channel and the ↑ to select the Range  
 Note: The span gas value used for this channel and range is highlighted and can be changed if necessary.

Use the **Enter** key and the **NUMERIC** keys as required.

## 2.7 Outputs: F10 From the MEASUREMENT screen

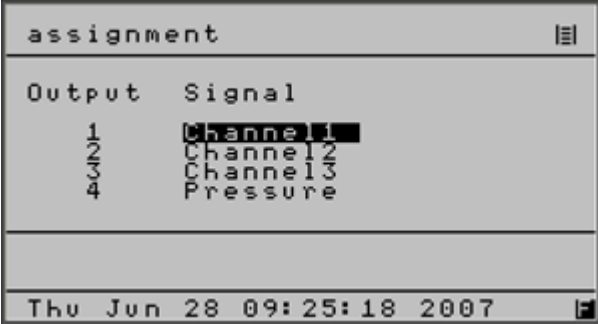

Output	Signal
1	Channel 1
2	Channel 2
3	Channel 3
4	Pressure

Thu Jun 28 09:25:18 2007

Use this screen to define the signals and their location that will be monitored by a remote reordering device.

Use the  $\updownarrow$  to select the desired Output. Press Enter to select  
Use the  $\updownarrow$  to select the desired Signal. Press Enter to select

Use this screen to define the signals and their location that will be monitored by a remote reordering device.

**SEE TABLE D**

### 3.0 NEW FUNCTIONS

#### 3.1 Auto Start Up: (Main, F5, F7, F7)

Auto Startup				
.Auto Startup	:	On		
.Wait for [min]	:	1		
.Access Level	:	1		
.Remote/Manual	:	Manual		
		Ch1	Ch2	Ch3
.Calibrations	:	1	1	1
.Startrange	:	1	1	1
MAIN SAVE				
BACK SAVE				
Mon Jan 01 01:40:07 2001				

All key analyzer parameters are stored in a secure memory location and retained when power is removed

In the event of an unexpected power failure it may be desirable to change some parameters until an operator can resume control.

This screen may be used to establish several desirable special instrument start-up parameters that define how the analyzer recovers from loss of AC power

When enabled this screen will define the following:

**Wait:** The time delay in minutes before proceeding. If **zero** is selected the instrument will not start until all temperature warnings are cleared

**Calibrations:** The number of attempts to complete a successful calibration as required in the operator defined Deviation Tables.  
If calibration is not successful the instrument will continue reporting results using the last completed calibration.  
The analyzer can be configured use the previous calibration by selecting zero Calibrations.

**Starting Range:** When all defined actions are completed the analyzer will return to the Measurement Screen and to the range specified.

**Access Level:** The user level at Start Up

**Remote/Manual:** Put the analyzer in either "Remote" or "Manual" at Start Up



### 3.2 Alarms On/Off: (Main, F5, F7)

All key analyzer parameters are stored in a secure memory location and retained when power is removed. In the event of an unexpected power failure it may be desirable to change some parameters until an operator can resume control.

This screen may be used to establish several desirable special instrument start-up parameters that define how the analyzer recovers from loss of AC power.

When enabled this screen will define the following...

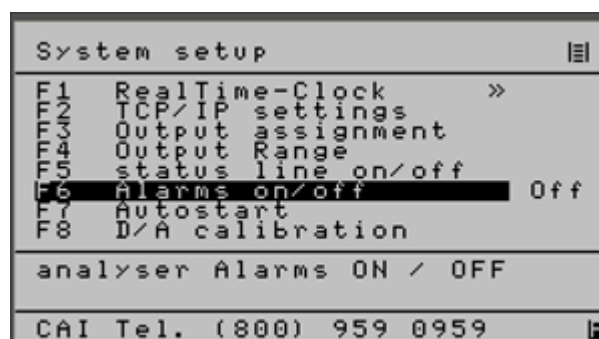

Use **F6** to toggle ON/OFF

The instrument has an extensive library of error messages that will aid in the identification of various anomalous events and are displayed at the bottom of the screen. These messages will assist in Diagnostics and indicating the need for preventative maintenance

This screen provides an **option** to disable these messages during initial start-up or as may be desired for a particular application.

### 3.3 Offset & Gain (Main, F4, F3, F5)

Offset and Gain		
Zero/ Span	applied	correction
	Offset	Gain
Range1:	0.00	1.00
Range2:	0.00	1.00
Range3:	0.00	1.00
Range4:	0.00	1.00
[CO2 ]	CO	O2
	← to select channel	
CAI Tel. (800) 959 0959		

This screen can be used to provide an additional means to display calibration deviations.

Use ← → keys to change channel.

The OFFSET is the value stored during zero calibration.

The GAIN is the value stored during span gas calibration using the operator defined calibration gas.

An increasing or decreasing change to the OFFSET or GAIN when used in conjunction with “Deviations” will provide insight to both short and long term changes to system performance

### 3.4 Calibrate The Analog Outputs: Main, F5, F7, F8 D/A Calibration Main, F5, F7, F3 Output Assignment

- **Overview**

The 600 NDIR Series of instruments are designed to provide analog outputs that can be configured as 0-1 VDC, 0-5 VDC, 0-10 VDC, 4-20 mA, or 0-20 mA.

With this version the outputs can also be configured to include an additional 1.0 volt and 5.0 volt output and a **calibration** capability.

The outputs can be calibrated to exactly match the results obtained on a PLC, Recorder, Data Logger or other remote recording device that may be connected to the analyzer.

The operator will first select the **OUTPUT ASSIGNMENT (Main, F5, F7, F3)** screen and choose the output that is to be calibrated. By selecting “calibrate” as the output all outputs of interest may be selected. When calibration is completed, the operator will return the outputs to their original assignment

The **D-A CALIBRATION** screen will then be used to complete the calibration procedure.

Output	Offset	Gain
1	1.8000	0.7000
2	1.8000	0.7000
3	1.8000	0.7000
4	1.8000	0.7000

\*\*Set Output-F3-Calibrate\*\*

MAIN / BACK SAVE  
FS F1:0% F5:100%

This screen provides a section that is used to record the zero signal corrections (zero offset) and a second area to record the 100% signal corrections (Gain) for each of the four output signals that may be defined to develop a voltage or current signal..

Since this is a Digital to Analog conversion, the calibration will require the completion of a simple “trial and error” procedure. The operator will observe the results of a “zero” or “span” (Gain) signal generated by the analyzer to the remote recording device and select a correction factor. The operator will save this value and then observe the results on attached the remote recording device.

The process of selection and saving for “zero” and “span” will be repeated until a satisfactory calibration is achieved. For 0-1VDC, 0-5VDC, 0-10VDC and a 0-20 mA outputs the Offset and Gain values are independent and do not interact. With the 4-20 ma output, the Offset “zero” and Gain “span” values interact and may require a few more trials.

The following is a table of typical values:

OUTPUT	OFFSET	GAIN
0-20 ma	0.000	0.927
4-20 ma	1.820	0.740
0-1 V	1.300	0.820
0-5 V	1.100	0.820
0-10 V	1.050	0.820

- **Procedure**

3.4.1 From the Main Menu press **F5, F7, F3**, to obtain following screen:

Output	Signal	mA
1	Channel1	
2	Channel2	
3	Channel3	
4	Flow1	

**Main, F5, F7, F3**

3.4.2 Use the  $\uparrow$  to highlight the outputs that require calibration.

3.4.3 Press enter to provide access to all the menu of signals that are available. (Real Time). Channel 1, Channel 2, Calibration, Sample pressure, etc.)

3.4.4 Select Calibration and press **ENTER** to complete the selection

Output	Signal
1	Calibrate
2	Channel2
3	Channel3
4	Flow1

CAI Tel. (800) 959 0959

Note: Any or all of the four outputs can be selected for calibration  
This screen will not be used again until calibration has been completed.

3.4.5 Press **BACK** to return to the SYSTEM SETUP screen (**F5, F7** from the main menu)

3.4.6 Press **F8** to obtain the following screen:

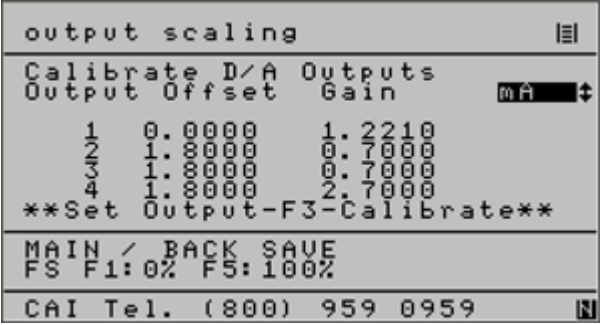

```
output scaling
-----
Calibrate D/A Outputs
Output Offset Gain
1 0.0000 1.2210
2 1.8000 0.7000
3 1.8000 0.7000
4 1.8000 2.7000
**Set Output-F3-Calibrate**
MAIN / BACK SAVE
FS F1: 0% F5: 100%
CAI Tel. (800) 959 0959
```

**MAIN, F5, F7, F8**

3.4.7 Use the  $\uparrow$  to select the desired output press **ENTER**

3.4.8 Press **F1** to select a ZERO signal and observe the results on the remote device

3.4.9 Change the offset value press **BACK** to save the new value.

3.4.10 Press **F8** to return to the D-A Calibration screen and note the results on the remote device.

3.4.11 Repeat steps 3.4.8 thru 3.4.10 until a satisfactory ZERO calibration is achieved.

3.4.12 Complete steps 3.4.8 thru 3.4.10 for each of the remaining outputs that require calibration.

3.4.13 Press **F5** to produce a full scale (100%) signal

3.4.14 Use the arrow keys to position the cursor at the require GAIN value

3.4.15 Observe the results on the remote device and make a correction to the GAIN value for the output of interest. Press **BACK** to save this new value

3.4.16 Press **F8** to return to the D-A calibration screen

3.4.17 Observe the results on the remote device and repeat steps change the GAIN value by repeating steps 3.4.14 thru 3.4.16 as needed for each output.

3.4.18 Return to the OUTPUT Assignment screen **F5, F7, F3** from the main menu and change the output signals from CALIBRATE to their original values as defined in step 3.4.1.

### 3.5 Save Data Archiving Time (F5, F7, F1, F5)

Archive Time is the Time in seconds between each set of data points. If “zero” no data is stored in the SEC data files. The SEC data files are in .CSV format for direct import into Excel. CAI can provide the tools necessary to download these files.

Setup RTC		
F1	Set time	
F2	Set autocalibration time	
F3	Select calibration range	
F4	Autocalibration on/off	
F5	Save Data Archiving Time	
	Archive Time(secs)	10
F10	Show time	
Archive Interval		
0 = Off F5:SAVE		
CAI Tel. (800) 959 0959		

Use ENTER to change recording time

**SEE TABLE A**

---

**TABLE A****600 SERIES NDIR DATA ARCHIVE FILES**

Time,  
Date,  
Month,  
Year,  
Error Index,  
TimeStamp,  
Pressure,  
Temperature,

Name,  
Concentration,  
Detector Volts,  
Range,  
Auto / Manual,  
Span Value,  
Offset,  
Gain,  
Sample Pressure,  
Sample Flow,  
Sample EPC Volts,  
Detector Temperature,  
Meas Mode,  
Local / Remote,

If 2 Channel this data is added

Name,  
Concentration,  
Detector Volts,  
Range,  
Auto / Manual,  
Span Value,  
Offset,  
Gain,  
Sample Pressure,  
Sample Flow,  
Sample EPC Volts,  
Detector Temperature,  
Meas Mode,  
Local / Remote,

**TABLE A (cont)**

**600 SERIES NDIR DATA ARCHIVE FILES**

If 3 channel this data is added

Name,  
Concentration,  
Detector Volts,  
Range,  
Auto / Manual,  
Span Value,  
Offset,  
Gain,  
Sample Pressure,  
Sample Flow,  
Sample EPC Volts,  
Detector Temperature,  
Meas Mode,  
Local / Remote,



### 3.6 User Digital Outputs

- **Overview**

The 600 NDIR Series of instruments have 15 solid state, optically coupled, isolated relays that can be programmed by the operator to indicate the status of numerous signals.

The available digital signals consist of a SERVICE Group that can be used to externally monitor a number of conditions to aid in preventative maintenance and diagnostics. **SEE TABLE B & D**

A second STATUS group is provided and is used to define the operation of the instrument such as Spanning, Zeroing, Calibrating, and the current Range (1, 2, 3, 4 AUTO) etc. **SEE TABLE C & D**

The individual output signals can be operator selected and set to a **HOLD** or **CLEAR** mode.

In the **HOLD** mode an activated signal is retained until the operator returns to the **Digital Output Screen** and selects the appropriate output signal and performs a manual CLEAR. After performing a Clear Operation, the operator must press **F2** again to put the outputs back onto **HOLD** mode.

```

User DO I          K2: STBY  |
-----|-----
1  Off
2  Off
3  Off
4  Off             *****
5  Off             *Set Unused *
6  Off             *Channels Off*
7  Off             *****
F2 Hold / Clear   Hold
-----|-----
F1 8 to 15 DO's
MAIN/BACK to SAVE
    
```

In the **Clear** Mode the signal will automatically change when the microprocessor detects that the noted condition no longer exists.

```

User DO II         K2: SMAN  |
-----|-----
8  Off
9  Off
10 Off
11 Off            *****
12 Off            *Set Unused *
13 Off            *Channels Off*
14 Off            *****
15 Off
-----|-----
F1 1 to 7 DO's
MAIN/BACK to SAVE
Check Ch1: Temp.
    
```

The operator can select from the following the desired **SERVICE** or **STATUS** groups that are to be digitally monitored.

**TABLE B**

<b>Index</b>	<b>Service Group</b>	<b>User DO Screen Display</b>
0		
1	Flow 1 Failure	F1
2	Flow 2 Failure	F2
3	Flow 3 Failure	F3
4	Extern Analog 1 Failure	E1
5	Extern Analog 2 Failure	E2
6	Pressure Failure	P
7	Temperature Failure	T
8	Channel 1 is not calibrated	1NC
9	Channel 2 is not calibrated	2NC
10	Channel 3 is not calibrated	3NC
11	Ch1: Low conc. Warning	1LoC
12	Ch2: Low conc. Warning	2LoC
13	Ch3: Low conc. Warning	3LoC
14	Ch1: High conc. Warning	1HiC
15	Ch2: High conc. Warning	2HiC
16	Ch3: High conc. Warning	3HiC
17	Ch1: Temperature!	1DT
18	Ch2: Temperature!	2DT
19	Ch3: Temperature!	3DT
20	Ch1: EPC failure	1EV
21	Ch2: EPC failure	2EV
22	Ch3: EPC failure	3EV
23	Ch1: Range overflow	1OR
24	Ch2: Range overflow	2OR
25	Ch3: Range overflow	3OR
26	Ch1: ADC Range Overflow	1AU
27	Ch2: ADC Range Overflow	2AU
28	Ch3: ADC Range Overflow	3AU
29	Ch1: ADC Range Underflow	1AO
30	Ch2: ADC Range Underflow	2AO
31	Ch3: ADC Range Underflow	3AO
32	dummy text for RTC	Off
33	<b>General Alarm</b>	<b>G</b>
35	<b>1 Cal Alarm</b>	<b>1CA</b>
36	<b>2 Cal Alarm</b>	<b>2CA</b>
37	<b>3 Cal Alarm</b>	<b>3CA</b>
34	<b>In Remote</b>	<b>R</b>

**TABLE C**

<b>Index</b>	<b><u>STATUS GROUP</u></b>	<b>User DO Screen Display</b>
38	1 AutoRange	1AR
39	1 Range 1	1R1
40	1 Range 2	1R2
41	1 Range 3	1R3
42	1 Range 4	1R4
43	1 In Calibrate	1C
44	1 In Zero	1Z
45	1 In Span	1S
46	1 In Sample	1Sa
47	2 Auto Range	2AR
48	2 Range 1	2R1
49	2 Range 2	2R2
50	2 Range 3	2R3
51	2 Range 4	2R4
52	2 In Calibrate	2C
53	2 In Zero	2Z
54	2 In Span	2S
55	2 In Sample	2Sa
56	3 Auto Range	3AR
57	3 Range 1	3R1
58	3 Range 2	3R2
59	3 Range 3	3R3
60	3 Range 4	3R4
61	3 In Calibrate	3C
62	3 In Zero	3Z
63	3 In Span	3S
64	3 In Sample	3Sa

Typical Relay

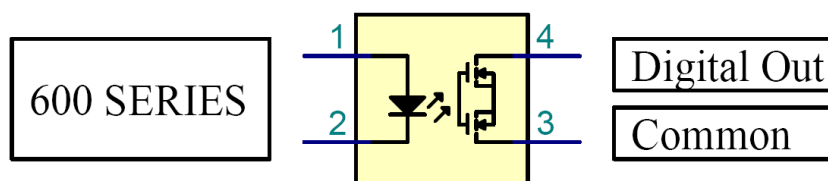

These contacts (3, 4) will drive continuously up to 500 MA using a customer voltage supply that does not to exceed 60 VDC.

- **Operation**

Use **(Main, F5, F9)** to select the first eight outputs

Use the  $\uparrow$  to select the desired output

Press ENTER and use  $\uparrow$  to select desired item

Press ENTER to save selection

NOTE: The 600 NDIR has 14 user selectable isolated digital outputs from the list of 64 in **TABLE B & C**

```

User DO I          K2: STBY  |  |
-----|-----|-----|
1      Off
2      Off
3      Off          *****
4      Off          *Set Unused *
5      Off          *Channels Off*
6      Off          *****
7      Off
F2 Hold / Clear   Hold
-----|-----|-----|
F1 8 to 15 DO's
MAIN/BACK to SAVE
  
```

Press **F1** to observe the remaining seven outputs  
Program as desired per the above

```

User DO II        K2: SMAN  |  |
-----|-----|-----|
8      Off
9      Off
10     Off
11     Off          *****
12     Off          *Set Unused *
13     Off          *Channels Off*
14     Off          *****
15     Off
-----|-----|-----|
F1 1 to 7 DO's
MAIN/BACK to SAVE
-----|-----|-----|
Check Ch1: Temp.
  
```

## 4.0 CHANGES TO EXISTING FUNCTIONS

### 4.1 Saved or Outside Limits

During Manual Calibration the following screens will be displayed to indicate the instruments response to the value of the zero or span gas using the amount that the operator defined in the deviation table.

Manual Zero	K1:SMAN	Manual Span	K2:SARE
Zero gas. Use F3 To Toggle Diagnostics Cal Via *Using Current Temp & Press* ***Saved Current*** 0.00		Span gas. Use F3 To Toggle Diagnostics Cal Via *Using Current Temp & Press* Outside Deviation Limits 0.02	
Channel: 0 Range: 0		Channel: 0 Conc.: 5.00000 Range: 0	
F1 Save value F2 Man. Cal. Menu		F1 Save value F2 Man. Cal. Menu	
Wed May 14 16:42:09 2008		CAI Tel. (800) 959 0959	

The Above is shown using Zero and Span Cal

From Measurement use: **F5 “zero” or F6 “span”**  
From Main Menu use: **F4, F2, F1 “zero” or F2 “span”**

### 4.2 Calibration Deviations.

MAIN, F5, F2, F2 Deviations, F3 Measuring Deviations.

Deviations[%]		
	absolute	relative
Range 1:	10.00	10.00
Range 2:	10.00	10.00
Range 3:	10.00	10.00
Range 4:	10.00	10.00

Enter deviations for channel : 1

CAI Tel. (800) 959 0959

Measuring deviation[%]	
Range 1:	1.00
Range 2:	1.00
Range 3:	1.00
Range 4:	1.00

Enter deviations for channel : 1

Sun Jan 01 00:11:48 2003

Note: These screens are used by the operator to define the maximum acceptable limits of the Zero and Span gas for both Manual and Automatic Calibrating.

### 4.3 Flow Zero or Span

Some analyzers have the above and the ability to flow Zero and Span Gas.

Manual calib		K1: SNGA
F1	Cal zero	0.02
F2	Cal span	ZERO
F3	Toggle zero	
F4	Toggle span	
F5	Measurements	
F6 Range Up ** F7 Range Down		
[CO2]	CO	O2
R1-16.00	AR1-100.0	R1-25.00
Wed May 14 16:45:58 2008		

Manual calib		K1: SARA
F1	Cal zero	0.01
F2	Cal span	SPAN
F3	Toggle zero	
F4	Toggle span	
F5	Measurements	
F6 Range Up ** F7 Range Down		
[CO2]	CO	O2
R1-16.00	AR1-100.0	R1-25.00
Wed May 14 16:47:28 2008		

The above is shown using Zero/SPAN Gas

From Cal Screen use: **F2 or Main or Back**  
 From Main Menu use: **F4, F2**

4.4 Reset Calibration Values

When the re-set calibrations value function is used all recorded deviations will be set to zero

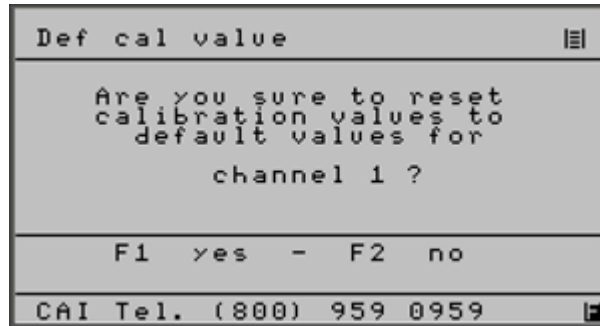

MAIN, F4, F5

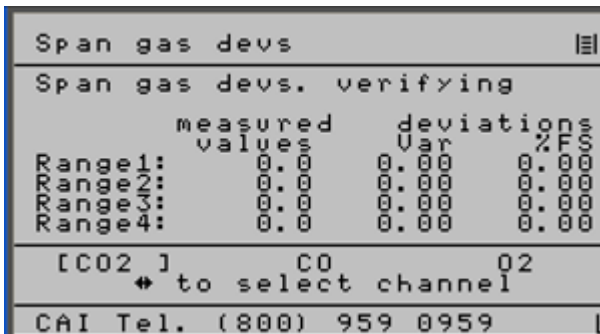

Main, F4 F3, F4

(Used to observe Auto Cal Results)

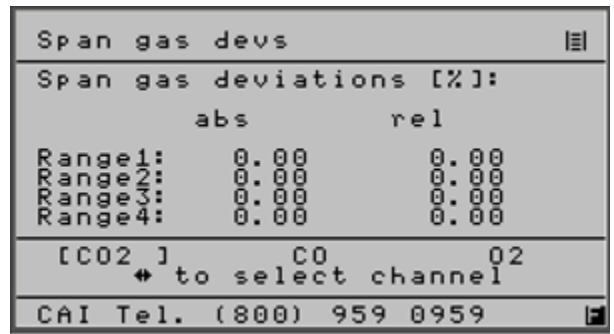

Main, F4, F3, F2

(Used to observe Manual Cal results)

The above are the new deviations after the operator elects to re-set the calibration values

## TABLE D

### 600 NDIR SERIES I/O CHART

#### 28 PIN MAIN CONNECTOR ASSIGNMENTS

AO = Analog Output, OC= Open Collector, SV = Solenoid Valve TTL = Transistor Logic

OPTO I/O	Signal Type	601 Analog	602 Analog	603 Analog	Levels
ALG 1		pin #	pin #	pin #	
COM	A Output	1 GND (Isolated analog)	1 GND (Isolated analog)	1 GND (Isolated analog)	<u>Isolated AI</u> 1v,5v,10v,mA
0	A Output	2 User Defined AO-1	2 User Defined AO-1	2 User Defined AO-1	
1	A Output	3 User Defined AO-2	3 User Defined AO-2	3 User Defined AO-2	
2	A Output	4 User Defined AO-3	4 User Defined AO-3	4 User Defined AO-3	
3	A Output	5 User Defined AO-4	5 User Defined AO-4	5 User Defined AO-4	
<b>DIG 1</b>		<b>Digital</b>	<b>Digital</b>	<b>Digital</b>	
COM	D Output	6 GND (Digital)	6 GND (Digital)	6 GND (Digital)	TTL-low true
0	D Output	7 Sense Auto Range	7 Sense Auto Range	7 Sense Auto Range	
1	D Output	8 Sense Range 1	8 Sense Range 1	8 Sense Range 1	
2	D Output	9 Sense Range 2	9 Sense Range 2	9 Sense Range 2	
3	D Output	10 Sense Range 3	10 Sense Range 3	10 Sense Range 3	TTL-low true
4	D Output	11 Sense Range 4	11 Sense Range 4	11 Sense Range 4	TTL-low true
5	D Input	12 Set Auto Range	12 Set Auto Range	12 Set Auto Range	
6	D Input	13 Control Range 1	13 Control Range 1	13 Control Range 1	
7	D Input	14 Control Range 2	14 Control Range 2	14 Control Range 2	
8	D Input	15 Control Range 3	15 Control Range 3	15 Control Range 3	
9	D Input	16 Control Range 4	16 Control Range 4	16 Control Range 4	
10	D Input	17 Auto Cal	17 Auto Cal	17 Auto Cal	
11	D Input	18 Calibrate	18 Calibrate	18 Calibrate	
12	D Input	19 Zero	19 Zero	19 Zero	
13	D Input	20 Span	20 Span	20 Span	
14	D Input	21 Sample	21 Sample	21 Sample	
15	SPARE				
<b>DIG 2</b>					
0	D Output	22 Zero Gas Flow	22 Zero Gas Flow	22 Zero Gas Flow	OC (24vdc if internal SV) OC (24vdc if internal SV) OC (24vdc if internal SV)
1	D Output	23 Span Gas Flow	23 Span Gas Flow	23 Span Gas Flow	
2	D Output	24 Sample Gas Flow	24 Sample Gas Flow	24 Sample Gas Flow	
3	D Output	25 Local/Remote	25 Local/Remote	25 Local/Remote	TTL-low true TTL-low true
4	D Output	26 Read Cal Mode	26 Read Cal Mode	26 Read Cal Mode	
5	D Output	27 Reserved	27 Reserved	27 Reserved	
6	D Output	28 Reserved	28 Reserved	28 Reserved	



**TABLE D**  
**600 NDIR SERIES I/O CHART**

**28 PIN AUXILLARY CONNECTOR ASSIGNMENTS**

OPTO I/O	Signal Type	601/602/603 Analog		LEVELS
ALG 1	Spare	pin #		
COM 4	A Input	1	GND (analog)	
5	A Input	2	External Analog 1	0-10V
6	A Input	3	External Analog 2	0-10V
7	A Output	4	<b>GND (Isolated analog)</b>	
	D Output	5	<b>Relay RTN 1</b>	<b>9,10,11,12 use RTN 1</b>
<b>DIG 3</b>	<b>Alarms</b>	<b>Digital</b>		<b>Alarms go OPEN when present</b> <b>Status go CLOSED when active</b>
COM 6	D Output	6	<b>Relay RTN 2</b>	<b>13,14,15,16 use RTN 2</b>
0	D Output	7	<b>Relay RTN 3</b>	<b>17,17,19,20 use RTN 3</b>
1	D Output	8	<b>Relay RTN 4</b>	<b>21,27,28 use RTN 4</b>
2	D Output	9	<b>User Defined NO Relay 1</b>	
3	D Output	10	<b>User Defined NO Relay 2</b>	
4	D Output	11	<b>User Defined NO Relay 3</b>	
5	D Output	12	<b>User Defined NO Relay 4</b>	
6	D Output	13	<b>User Defined NO Relay 5</b>	
7	D Output	14	<b>User Defined NO Relay 6</b>	
8	D Output	15	<b>User Defined NO Relay 7</b>	
9	D Output	16	<b>User Defined NO Relay 8</b>	
10	D Output	17	<b>User Defined NO Relay 9</b>	
11	D Output	18	<b>User Defined NO Relay 10</b>	
12	D Output	19	<b>User Defined NO Relay 11</b>	
13	D Output	20	<b>User Defined NO Relay 12</b>	
14	D Output	21	<b>User Defined NO Relay 13</b>	
15	D Output	22	<b>Reserved Do Not Connect</b>	
<b>DIG 2</b>				
7	D Input	23	Spare	
8	D Input	24	Spare	
9	D Input	25	Spare	
10	D Input	26	<b>Set Remote</b>	
11	D Output	27	<b>User Defined NO Relay 14</b>	
12	D Output	28	<b>User Defined NO Relay 15</b>	