

600

SERIES

HELD



USER'S MANUAL

Note: For Analyzers Sold After June 2007 Please See Addendum Starting After Page 71 of This Manual



1312 West Grove Avenue
Orange, CA 92865-4134
Phone: 714-974-5560 Fax: 714-921-2531
www.gasanalyzers.com



Safety Alert
Caution or Warning



Temperature Hazard
Caution or Warning



Electrical Shock Hazard
Caution or Warning

Safety Information in this Manual

Note, caution and warning symbols appear on the instrument and throughout this manual to draw your attention to important operational and safety information.

A “**NOTE**” marks a short message to alert you to an important detail.

A “**CAUTION**” safety alert appears with information that is important for protecting your equipment and performance.

A “**WARNING**” safety alert appears with information that is important for protecting you, others and equipment from damage. Pay very close attention to all warnings that apply to your application.



The  symbol (an exclamation point in a triangle) precedes a general CAUTION or WARNING statement.



The  symbol (wavy vertical lines with an under score in a triangle) precedes an elevated temperature hazard CAUTION or WARNING statement.



The  symbol (a lightning bolt in a triangle) precedes an electric shock hazard CAUTION or WARNING statement.

Some or all of the above symbols may appear in this manual or on the equipment. This manual should be consulted whenever one of these symbols is encountered on the equipment.

ALWAYS REMOVE POWER BEFORE CONNECTING OR DISCONNECTING SIGNAL CABLES OR WHEN SERVICING THE EQUIPMENT.

The 600 series HCLD instruments meet or exceed the following directives and standards.

Application of Council Directive(s):

Electrical Safety:

Low Voltage Directive 73/23/EEC

Electromagnetic Compatibility:

EMC Directive 89/336/EEC

Standard(s) to which Conformity is Declared:

Electrical Safety:

*Standard for Electrical Equipment for Measurement, Control, and Laboratory Use
[EN 61010-1:2001 (2nd Edition)]*

Electromagnetic Compatibility:

EN 61326:1997 Electrical equipment for measurement, control and laboratory use - EMC requirements (Amendment A1: 1998 to EN 61326:1997; Amendment A2:2001 to EN 61326:1997)



Do not apply power to the analyzer or attempt to energize the ozone supply or converter until **ALL** leak checks have been performed and until the analyzer environment has been determined to be non-hazardous.

This analyzer is designed for use in a **NON-HAZARDOUS** environment.

This analyzer is designed for use with a **HAZARDOUS** sample.



Tampering or use of substitute components may cause a safety hazard. Use only factory authorized replacement parts.



Do not operate without the cover secured. Servicing requires access to live electrical components which can cause death or serious injury. Refer servicing to qualified service personnel. For safety and proper performance, this instrument must be connected to a properly grounded three-wire receptacle.



This analyzer produces high levels of ozone (.4% maximum) that can be dangerous to the health of the operator and surrounding personnel. Be sure to only use this instrument with proper ventilation And exhaust lines.

TABLE OF CONTENTS

<u>Section</u>	<u>Title</u>	<u>Page</u>
1.	INTRODUCTION-----	1
1.1.	Overview-----	1
1.2.	Unpacking Instructions-----	1
1.3.	Reporting Damage-----	1
1.4.	Contact Information-----	1
1.5.	Warranty Certificate-----	2
2.	FEATURES AND SPECIFICATIONS-----	3
3.1.	Descriptions-----	3
2.2.	Features-----	3
2.3.	Specifications-----	4
3.	INSTALLATION-----	5
3.1.	General-----	5
3.2.	Site and Mounting-----	5
3.3.	Electrical-----	5
3.4.	I/O Analog Connections-----	5
3.5.	Required Gases-----	5
3.6.	Gas Handling Equipment-----	5
3.7.	Gas Connections-----	5
3.8.	Sampling Requirements-----	7
3.8.1.	Filtration-----	7
3.8.2.	Condensation-----	7
3.8.3.	Presence of Corrosive Gases-----	7
3.8.4.	Gas Temperature-----	7
3.8.5.	Flow Rate-----	7
3.8.6.	Sample Gas Outlet-----	8
4.	BASIC OPERATION-----	9
4.1.	Display-----	9
4.2.	Menu Tree-----	10
4.3.	Keyboard-----	11
4.4.	Operation with Cursor Keys-----	11
4.5.	Operation with Function Keys-----	11
4.6.	Read and Change Parameters-----	11
5.	OPERATING STRUCTURE-----	12
5.1.	Main Menu-----	12-13

6.	MENU STRUCTURE -----	14
6.1.	User Functions (Level 1)-----	14
6.2.	Advanced User Functions (Level 2)-----	14
6.3.	Maintenance User Functions (Level 3)-----	14
6.4.	System User Functions (Level 4)-----	14
7.	MAIN MENU -----	15
7.1.	F1 Measurements -----	15
7.1.1.	F1 NO or NOx Measurement-----	16
7.1.2.	F2 NO + NO2 Measurement -----	15-16
7.1.3.	F3 Diagnostics-----	16
7.1.4.	Arrow Keys to Cycle Ranges and Auto Range-----	17
7.2.	F2 Purge Analyzer -----	18
7.3.	F3 Diagnostics -----	18
7.4.	F4 Calibrations -----	19
7.4.1.	F1 Automatic Calibration -----	19-20
7.4.2.	F2 Manual Calibration-----	20-21
7.4.3.	F3 Display Deviations -----	21-22
7.4.4.	F4 Check Calibration Values -----	22
7.4.5.	F5 Reset Calibration Values-----	22
7.4.6.	F6 Range Select -----	22
7.5.	F5 Setup-----	23
7.5.1.	F1 Span Gas Concentrations -----	24
7.5.2.	F2 Calibration Settings-----	24
7.5.2.1.	F1 Times -----	24
7.5.2.2.	F2 Measuring Deviations -----	25
7.5.2.3.	F3 Deviations-----	25
7.5.2.4.	F4 Calibration via Valves -----	25
7.5.2.5.	F5 Calibration via Probe -----	25
7.5.3.	F3 Range Limits -----	25
7.5.3.1.	F1 Change Upper Range Limits -----	25
7.5.3.2.	F2 Change Auto Range Limits -----	26
7.5.4.	F4 Change Alarms-----	26
7.5.5.	F5 Password -----	27
7.5.5.1.	F1 Enter Password-----	27
7.5.5.2.	F2 Change Password -----	27
7.5.5.3.	F3 Reset Passwords-----	28
7.5.6.	F6 Linearization -----	28
7.5.7.	F7 System Settings-----	29
7.5.7.1.	F1 Clock Setup-----	29-30
7.5.7.2.	F2 TCP/IP Address -----	31

7.5.7.3.	F3 Output Signal Assignments-----	31
7.5.5.4.	F4 Output Ranges-----	31
7.5.7.5.	F5 Protocol On/Off-----	32
7.5.7.6.	F6 Set Language-----	32
7.5.7.7.	F7 Automatic Setup-----	32
7.5.8.	F8 Measure Settings-----	33
7.5.8.1.	F1 Set Purge Time Before Measure-----	33
7.5.8.2.	F2 Set Converter Efficiency-----	33
7.5.8.3.	F3 Set Time Constant-----	34
7.5.8.4.	F4 Set Purge Time Before Calibration-----	34
7.5.10.	F10 Display Software Version-----	34-35
7.6.	F7 Remote/Manual Operation-----	35
7.7.	F8 Standby-----	35
8.	ANALYZER COMPONENTS-----	36
8.1.	Rear Panel Connections-----	37
8.1.1.	Main Analog Connections-----	37
8.1.2.	Auxillary Analog Connections-----	37
8.1.3.	Digital (RS-232) Connections-----	37
8.1.4.	Digital (TCP/IP) Connections-----	38
8.2.	Internal Components-----	39
8.3.	Main Electronics Board (Potentiometers)-----	40
8.4.	Main Electronics Board (Connections)-----	41
8.5.	Reaction Chamber-----	42
8.6.	Relay Board (Connections)-----	43
9.	OPERATION-----	44
9.1.	Preparation-----	44
9.2.	Operation-----	44-45
9.3.	Shut Down Procedure-----	46
10.	FUNCTIONAL DESCRIPTION-----	47
10.1.	Operating Principle-----	47
10.2.	Reaction Chamber Assembly-----	47
10.3.	Flow System-----	47
10.4.	Main Electronics Board-----	48
10.5.	Relay Board-----	48
11.	REACTION CHAMBER-----	49
11.1.	Reaction Chamber Disassembly-----	49
11.2.	Reaction Chamber Assembly-----	49
12.	TROUBLESHOOTING-----	50
12.1.	Ozone Air/O2 Supply-----	50
12.2.	Sample Supply-----	50
12.3.	NO/NOx Converter-----	50

13. APPENDIX	51
13.1. AK Protocol	52-63
13.2. Output Connections	64
13.3. Flow Diagrams	65-68
13.3. Electrical Block Diagram	69

1. Introduction

1.1. Overview

Congratulations and thank you! You have just purchased one of the most reliable gas analyzers in the world. Before using the analyzer, please familiarize yourself with its operation by reading this manual. If you have any questions, please do not hesitate to call California Analytical Instruments for assistance. We want you to be a member of our thousands of satisfied customers.

1.2. Unpacking Instructions

Open the shipping container and carefully remove the analyzer from the packing materials. Inspect the instrument for any sign of damage. Remove the Top Cover retaining screws. Visually check for loose parts or connectors that are not properly seated. Verify all circuit boards and circuit board connections are secure. If all internal components look normal, re-install the cover.

1.3. Reporting Damage

Should there be any apparent damage to either the inside or outside of the instrument due to shipping or handling, immediately notify the shipper. The shipping container or packing materials should be retained for inspection by the shipper.

1.4. Contact Information

California Analytical Instruments, Inc.
1312 West Grove Avenue
Orange, CA 92865
714 974-5560
Fax 714 921-2531
Website: www.gasanalyzers.com

1.5. Warranty Certificate

Subject to the exceptions and upon the conditions stated below, California Analytical Instruments (CAI) warrants that the products sold under this sales order shall be free from defects in workmanship and materials for one year after delivery of the product to the original Buyer by CAI and if any such product should prove to be defective within such one year period, CAI agrees, at its option, either (i) to correct by repair or, at CAI's election, by replacement with equivalent product any such defective product, provided that investigation and factory inspection discloses that such defect developed under normal and proper uses, or (ii) to refund the purchase price. The exceptions and conditions mentioned above are as follows:

- a) components or accessories manufactured by CAI which by their nature are not intended to and will not function for one year are warranted only to give reasonable service for a reasonable time; which constitutes reasonable time and reasonable services shall be determined solely by CAI. A complete list of such components and accessories is maintained at the factory;
- b) CAI makes no warranty with respect to components or accessories not manufactured by it; in the event of defect in any such component or accessory CAI will give reasonable assistance to Buyer in obtaining from the respective manufacturer whatever adjustment is authorized by the manufacturer's warranty;
- c) any product claimed to be defective must be returned to the factory transportation charges prepaid and CAI will return the repaired or replaced product freight collect;
- d) if the product claimed to be defective requires on-site repair, such warranty labor will be provided at no charge; however, transportation and living expenses will be charged to Buyer;
- e) if the product is a consumable or the like, it is warranted only to conform to the quantity and content and for the period (but not in excess of one year) stated on the label at the time of delivery or 90 days;
- f) CAI may from time to time provide a special printed warranty with respect to a certain product, and where applicable, such warranty shall be deemed incorporated herein by reference;
- g) CAI shall be released from all obligations under all warranties, either expressed or implied, if any product covered hereby is repaired or modified by persons other than its own authorized service personnel unless such repair by others is made with the written consent of CAI.

IT IS EXPRESSLY AGREED THAT THE ABOVE WARRANTY SHALL BE IN LIEU OF ALL WARRANTIES OF FITNESS AND OF THE WARRANTY OF MERCHANTABILITY AND THAT CAI SHALL HAVE NO LIABILITY FOR SPECIAL OR CONSEQUENTIAL DAMAGES OF ANY KIND OR FROM ANY CAUSE WHATSOEVER ARISING OUT OF THE MANUFACTURE USE, SALE, HANDLING, REPAIR, MAINTENANCE OR REPLACEMENT OF ANY OF THE PRODUCTS SOLD UNDER THIS SALES ORDER. SOME STATES DO NOT ALLOW THE EXCLUSION OR LIMITATION OF INCIDENTAL OR CONSEQUENTIAL DAMAGES, SO THAT THE ABOVE LIMITATIONS OR EXCLUSIONS MAY NOT APPLY. THIS WARRANTY GIVES YOU SPECIFIC LEGAL RIGHTS, AND YOU MAY ALSO HAVE OTHER RIGHTS, WHICH VARY FROM STATE TO STATE.

Representations and warranties made by any person, including dealers and representatives of CAI, which are inconsistent, or in conflict with the terms of this warranty, shall not be binding upon CAI unless reduced to writing and approved by an expressly authorized officer of CAI.

2. Features

2.1. Description

The CAI Model 600 HCLD Analyzer is a highly sensitive heated chemiluminescent (CLD) gas analyzer for measuring gas concentrations in industrial and vehicle emission applications. The analyzer includes a unique internal oven, which maintains ALL plumbing components in contact with the sample gas, before the detector, at an elevated temperature between 65 and 100 degrees Centigrade. (Temperature is Customer Specified)

2.2. Features-General

The Model 600 HCLD analyzer has a 3 by 5 inch liquid crystal display and a 20 key data/operation input keyboard. The 16 bit microprocessor control board consists of the MSR-Card with 16 digital inputs, 16 digital outputs, 16 analog inputs and 4 analog outputs. The analyzer can be manually operated from the keypad or remotely via TCP/IP or Rs-232C communications. After turning on the analyzer, it needs at least 30 seconds for initialization. During this time, the screen is illuminated but clear. The analyzer is available with an optional internal heated sample pump.

- + **IMPORTANT TIP:** When the analyzer is powered up, it defaults to access level 1 (User). To operate ALL parameters, check the access level. See Section 5.5.5.

The contents of this manual include:

- **Electrical Specifications**
- **Installation Requirements, Mechanical & Electrical**
- **Operation & Calibration Instructions**
- **Reaction Chamber Description with Procedures for Disassembly of its Component Parts**
- **Function Explanation of the Electronic Circuitry**
- **Block Electrical Diagram**

600 HCLD Analyzer SPECIFICATIONS

DETECTOR	Chemiluminescence (CLD) Photodiode (thermally stabilized with Peltier cooler)	
NO/NO_x RANGES	0-1 to 3,000 ppm NO or NO _x (Four user programmable ranges) <i>(Higher Ranges Available upon Request)</i>	
RESPONSE TIME	T90 < 2 Seconds to 60 Seconds Adjustable	
RESOLUTION	10 ppb NO/NO _x (Displays 5 significant digits)	
REPEATABILITY	Better than 0.5% of Full Scale	
LINEARITY	Better than 0.5% of Full Scale	
NOISE	Less than 1% of Full Scale	
ZERO & SPAN DRIFT	Less than 1% of Full Scale per 24 Hours	
ZERO & SPAN ADJ.	Via front panel, TCP/IP or RS-232	
NH₃, HCN & SO₂ EFFECT	Not detectable with 100 ppm	
CO₂ EFFECT	Less than 0.5% with 10% CO ₂	
FLOW CONTROL	Electronic Proportional Pressure Controller	
SAMPLE FLOW RATE	.5 to 3.0 LPM (See footnote below)	
CONVERTER	Vitreous Carbon Material @ 205°C > 98% efficiency	
OZONATOR	Ultraviolet Lamp	
AIR OR O₂ REQUIREMENTS	Less than 0.01 ppm NO _x at 350 cc/Min. @ 25 psig (Dew Point < -35°C)	
NO/NO_x Control	Manual/Remote/Auto Cycle (Remote NO _x mode by dry contact closure)	
OUTPUTS	TCP/IP, RS232, Four Scalable Analog 0-10 V / 4-20 mA Maximum	
DISCRETE ALARMS (Local & Remote Adjustable)	General Fault/ TTL Logic (Ground True) 0-5 VDC Maximum Calibration Failure/ TTL Logic (Ground True) 0-5 VDC Maximum High Concentration (2 each)/ TTL Logic (Ground True) 0-5 VDC Maximum	
DIGITAL DIAGNOSTICS	Control Voltages Temperatures	Pressures Flow Parameters
KEYPAD DISPLAYS	Factory Settings TCP/IP Address Passwords (4)	Scalable Analog Output Voltages Full Scale Range Select Auto Cal Times
SPECIAL FEATURES	Calculated NO ₂ derived from NO _x converter efficiency Auto Ranging Auto Calibration (adjustable through internal clock) Less than 3 cc Gold Plated Reaction Chamber	
DISPLAY	3" x 5" Back lit LCD	
SAMPLE TEMPERATURE	Up to 75°C Noncondensing – Standard <i>(Higher temperature available upon request)</i>	
AMBIENT TEMPERATURE	5 to 40°C	
AMBIENT HUMIDITY	Less than 90% RH Noncondensing	
WARM-UP TIME	1 Hour (Typical)	
FITTINGS	1/4 Inch Tube	
POWER	115V 60 Hz (Option: 230V 50 Hz) , Less than 3 amps	
DIMENSIONS	5¼ H × 19 W × 23 D (Inches)	
WEIGHT	55 Pounds	

Note: .5 to 1.5 l/min flow rate options available upon request only

3. Installation

3.1. General

The instrument is designed for industrial applications. These installation instructions are for a typical site. Any questions regarding specific installation situations should be directed to Technical Service of California Analytical Instruments, Inc.

3.2. Site and Mounting

NOTE: The following precautions must be carefully observed:

1. Select a site free from direct sunlight, radiation from a high temperature surface, or abrupt temperature variations.
2. This analyzer is not suitable for installation outdoors.
3. Select a site where the air is clean. Avoid exposing the instrument to corrosive or combustible gases.
4. The instrument must not be subject to severe vibration. If severe vibration is present, use isolation mounts.
5. The instrument is designed for rack-mounting. Optional rack mount slides are available.
6. Do not install near equipment emitting electromagnetic interference (EMI).

NOTE: A rear supporting brace or equivalent is required if the optional rack mount slides were not purchased.



The power on/off switch is accessible from the rear of the instrument only. DO NOT mount such that the power on/off switch is inaccessible.

3.3. Electrical

All wiring is connected at the rear of the instrument. Connect outputs, etc. as shown in Table 3-1 on the following page. The AC power is connected to the power/fuse/switch as shown below.

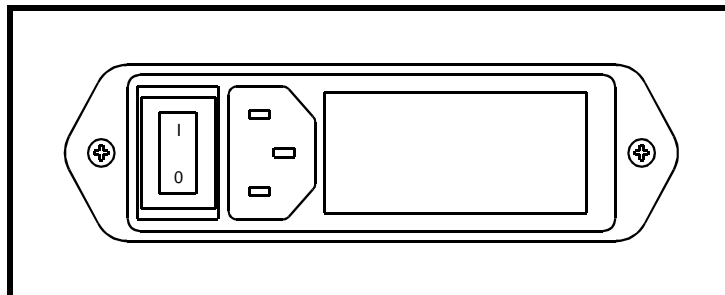

AC Power Switch, Connector, and Fuse.

NOTE: A defective ground may affect the operation of the instrument. The output voltages are connected per Table 8.1-1. Shielded wiring is recommended for output signals.



Replace fuses with recommended fuse size indicated on rear panel of instrument. Replacement with any other size fuse may cause damage to the instrument and possible injury to operating personnel.

3.4. Analog Output Connections (Appendix)

See Appendix for connector pinouts located on the analyzer rear panel. Remote range identification and range selection are obtained by the rear panel connections. When a range is selected, the corresponding control line is pulled low to zero VDC. Ranges not selected will remain at approximately 5 VDC. When remote range control is selected through the front panel keypad, a contact closure is provided at the rear panel connector. Remote range selection is made by connection of the control line for the desired range to the analyzers zero VDC line provided in the connector. Five VDC is also provided. Remote NOx On is selected by connection to the common line. This contact closure turns on the NOx function by flowing the sample first through the NO/NOx converter.

3.5. Gases

1. Air or O₂ (Ozone Air, < 1 ppm C) in pressurized cylinder.
2. Nitrogen or (zero air) in pressurized cylinder.
3. Standard span gas(es) near full scale concentration with a nitrogen balance, in a pressurized, certified cylinder.

3.6. Gas Handling Equipment

1. Pressure regulators for zero gas (Air or N₂), ozone supply (air or O₂) and span gas cylinders.
2. Corrosive resistant gas tubing.



High levels of Ammonia (greater than 10 PPM NH₃) may reduce the NO₂ to NO Converter's conversion efficiency to a level that is unacceptable. It is therefore recommended that the customer purchase a commercially available NH₃ scrubber and install it in the path of the sample gas prior to its introduction into the analyzer.

3.7. Gas Connections

The tubing from the sampling system to the gas analyzer should be made from corrosive-resistant material such as Teflon, stainless steel. Even when the gases being sampled are corrosive themselves, rubber or soft vinyl tubing should not be used since readings may be inaccurate due to gas absorption into the piping material. To obtain fast response, the tube should be as short as possible. Optimum tube internal diameter is 0.16 inch (4 mm). Couplings to the instrument are ¼ Inch tube.

NOTE

**Be sure tubing and joints are clean.
Dust entering the instrument may cause it to malfunction.**

3.8. Sampling Requirements

3.8.1. Filtration

Dust must be eliminated completely. Use filters as necessary. The final filter must be capable of removing particles larger than 4 microns.

3.8.2. Condensation

Dew point of the sample gases must be lower than the temperature of the oven to prevent accidental condensation within the instrument. When sample dew point is greater than the oven's preset temperature, pass the sample through a dehumidifier to reduce the dew point to prevent condensation. If the sample contains an acid mist, use an acid mist filter, cooler or similar device to remove all traces of the mist.

3.8.3. Presence of Corrosive Gases

Useful service life of the instrument will be shortened if high concentrations of corrosive gases such as Cl₂, SO₂, F₂, HCl, etc., are present in the sampled gas.

3.8.4. Gas Temperature

When measuring high temperature gases, take care that the maximum rating of the instrument 122 °F (100 °C) is not exceeded.

3.8.5 Pressure and Flow Rates

The air or oxygen supply entering the instrument is controlled by an electronically controlled proportional flow (EPC) controller. The regulator is factory adjusted for optimum analyzer performance. The ozone supply (Air or O₂) air cylinder pressure should be set at approximately 25 PSIG. The sample entering the instrument is controlled by a factory set precision electronically controlled proportional flow (EPC) controller. The EPC is factory set for optimum analyzer performance as indicated by the sample pressure. If the analyzer does not contain the optional heated sample pump, the sample gas entering the instrument should be at a pressure between 10 and 25 PSIG with a flow capacity at a minimum of 3 liters/min. If the analyzer contains the optional sample pump, do not apply a pressurized sample. The optional pump is capable of drawing a sample through a ¼ inch heated sample line of approximately 75 feet. The calibration/span gas cylinder pressures should be set at 25 PSIG for delivery into the optional zero and span inlets located on the rear panel.

3.8.6. Sample Gas Bypass Outlet (Vent)

A sample gas bypass outlet connector is located on the rear panel (¼ Inch Tube). Pressure at this outlet should be kept at atmospheric level. **ANY** backpressure will cause an error in reading. The vent outlet is located on the rear panel and may contain high levels of ozone which should be vented away from the instrument.

4. Basic Operation

The operation of the digital microprocessor conforms to the guidelines of the AK committee, originally developed in the German automotive industry. Via the serial port of the MSR-Card, the analyzer can be remote-controlled by a master computer. The serial communication fully corresponds to the specifications of the AK protocol. TCP/IP communication is also available.

4.1. Display

The analyzer's LCD display can show 16 lines with 30 characters each. The display also has background lighting that can be switched on and off via the Display key on the keyboard. The following example shows the measurement screen which is formatted into 4 information areas.

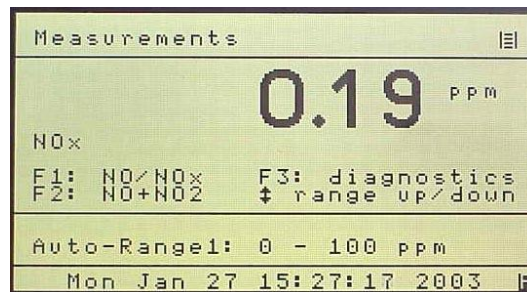

Measurement Screen

THE TOP INFORMATION AREA CONTAINS:

The AK Protocol Information. This capability is for advanced uses and may be toggled on and off in the setup screen, F5. Next to the symbol for the active operating mode, the device status is indicated. The status field is also displayed on all other screens.

- SARE Autorange enabled
- SMGA Measuring gas is flowing
- SMAN Device is in manual operation status

The level of Password Entry is shown on the right with 4 horizontal lines.

THE LARGE INFORMATION AREA CONTAINS:

The Concentration of the gas sample and mode of operation.

THE THIRD INFORMATION AREA CONTAINS:

The help information for the parameter selected, ranges, etc.

THE LOWER INFORMATION AREA CONTAINS:

The the time & date and any error condition.

The symbol in the bottom right corner indicates the keyboard mode. In the example shown, the keyboard is in the function key mode. For input fields, the mode is usually switched to numerical input. Then, an N appears in the lower right of the screen. This symbol is displayed on all screens.

4.2. Menu Tree

Main Menu (from "Main" Key) (p12)

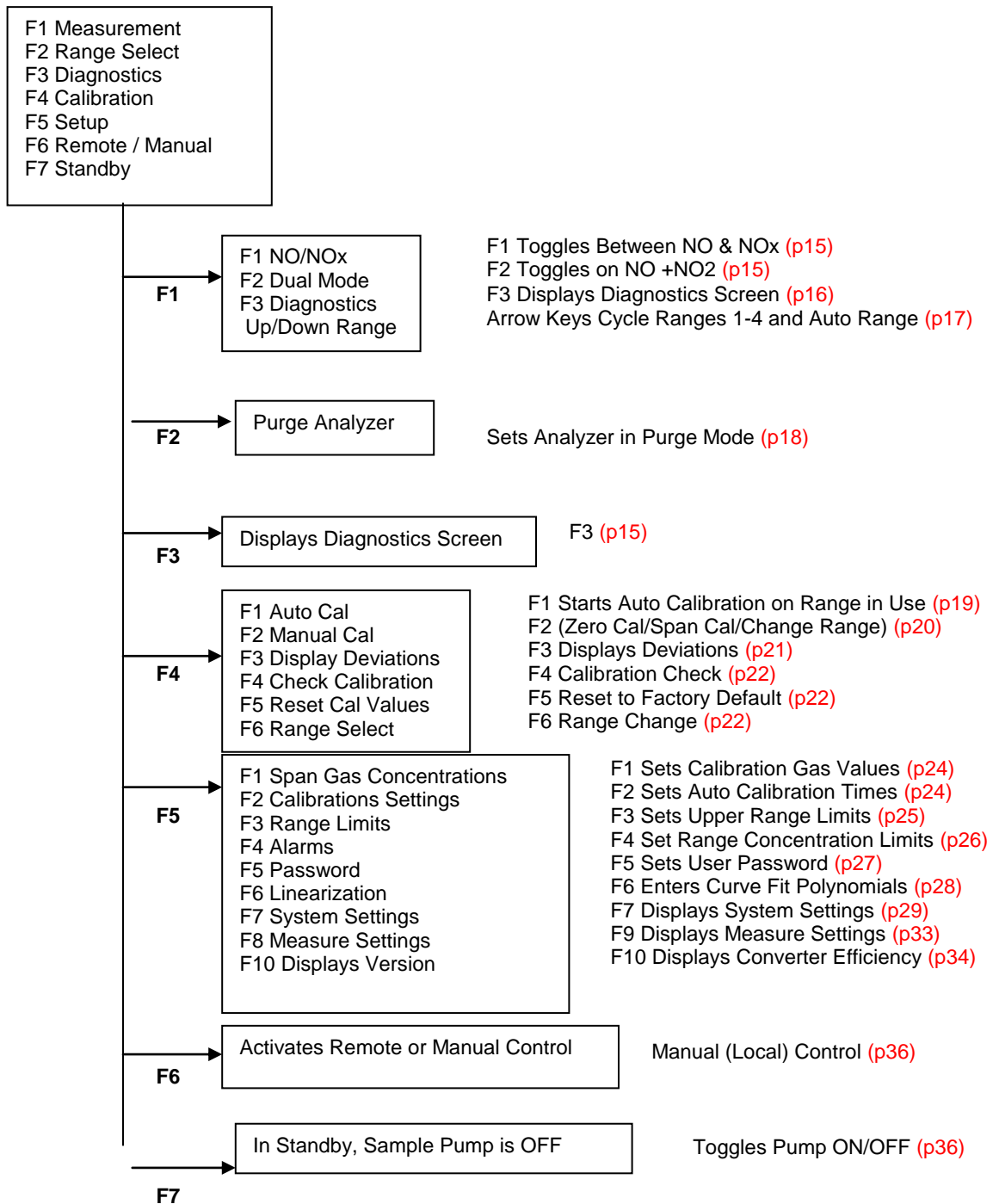

4.2. Keyboard

The keyboard looks as follows:

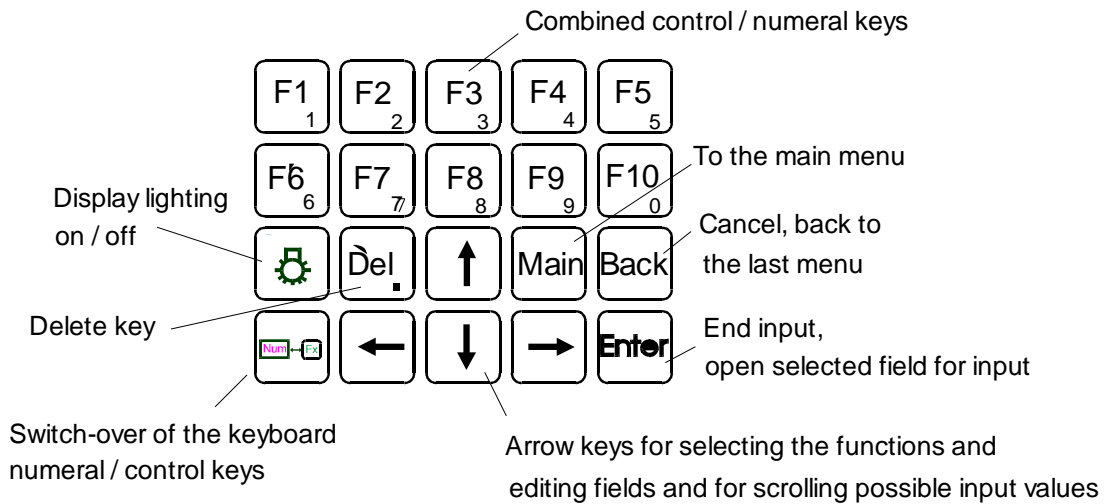

Figure 2 : Keyboard

4.3. Operation with the Cursor Keys and the Enter Key

When operating the unit with the cursor keys, you select the various functions with the up/down cursor keys and start them with the Enter key. This method is particularly suitable for less proficient users since the system displays a short on-line help for nearly every function selected. The actual cursor position is shown as a black horizontal bar.

+ **TIP:** If you are not yet familiar with the screens and their fields, just press any cursor key after a screen appears. This moves the cursor from field to field and displays the corresponding online help.

4.4. Operation with the Function Keys

When using the function keys (F1 through F10), you call functions directly by pressing their corresponding function keys. This method is suitable for the advanced user since it is faster than the operation with the cursor keys. There is, however, no on-line help for the various functions.

4.5. Read/Change Parameters

To read and/or change parameters, you must switch to the parameter input mode by pressing the Enter key after calling the corresponding parameter screen. The input cursor (horizontal bar under the first character) then appears in the active edit field (black background). The cursor can be positioned with the right and left cursor keys, and the value displayed (number or letter) can be changed with the up and down cursor keys or entered directly. Every input has to be concluded by pressing the Enter key again, which causes the cursor to disappear.

5. Operating Structure

The analyzer's operation can be divided into up to 4 operating levels. The current level is always displayed as a stack of 1 to 4 horizontal bars in the top right corner of the screen. In the access level menu, you can choose between the following operating levels:

F1	User	(operating level 1)
F2	Advanced user	(operating level 2)
F3	Maintenance	(operating level 3)
F4	System user	(operating level 4)

A password can be assigned to each operating level. Only the system user, who normally has the highest operating priority, can assign the password. At the factory, the default passwords for the CAI analyzers are set as follows:

User:	111
Advanced user:	222
Maintenance:	333
System:	444

The default setting can be changed only by the system user. This manual is written to include all information for the advanced system user.

- + **TIP:** Because of the user settings, some of the parameters shown in this manual may not appear on your analyzer. Check the access level.

5.1. The Main Menu

Upon power up, the CAI logo is first displayed and then the main menu appears as below:

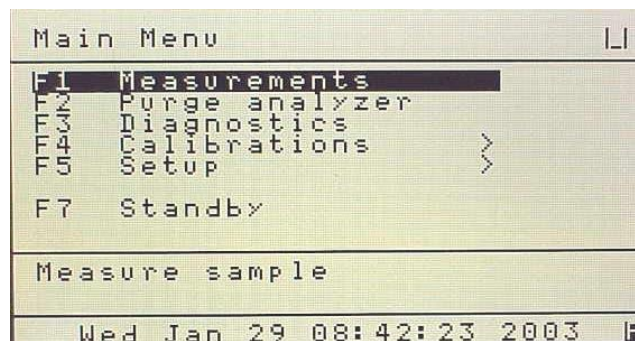

Main Menu on Power Up Screen

NOTE: F6 is not available because, on initial start up, the analyzer reverts to ONLY Level 1 access. See Section 7.5.5 for Password information.

All functions can be selected with the cursor keys and activated by pressing the Enter key, or directly with the function keys F1 through F7. A ">" to the right of a function means that one or more sub-menus are available. If this sign is missing, the function starts immediately after the activation.

NOTE: Access level is 4.

NOTE:
Access
Level
Indication

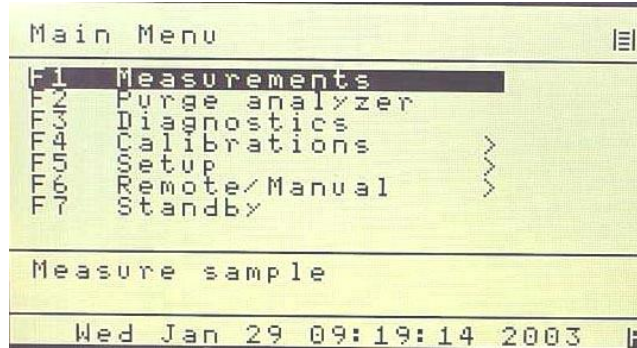

Main User Menu (Level 4)

6. Menu Structure

There are 4 operating levels based on the level of your password. This section shows the access rights of the single levels.

6.1. User Functions (Level 1)

Main Menu

F1 : Measurements
F2 : Purge Analyzer
F3 : Diagnostics
F4 : Calibrations
F5 : Setup
F7 : Standby

F5 :Setup

F5 : Password
F10:Version

F5 :Password

F1 :Enter password

6.2. Advanced User Functions (Level 2)

Main Menu

F1 : Measurements
F2 : Purge Analyzer
F3 : Diagnostics
F4 : Calibrations
F5 : Setup
F7 : Standby

F5 : Setup

F3 : Range Limits
F5 : Password
F10:Version

F5 :Password

F1 :Enter password

6.3. Maintenance Functions (Level 3)

Main Menu

F1 : Measurements
F2 : Purge Analyzer
F3 : Diagnostics
F4 : Calibrations
F5 : Setup
F7 : Standby

F5 : Setup

F1 : Span Gas Conc.
F3 : Range limits
F5 : Password
F7 : System Settings
F8 : Measure Settings
F10:Version

F5 :Password

F1 :Enter password
F2 :Reset password

F7:System Settings

F1 : Real Time Clock
F5 : Status Line on/off
F7 : Auto Startup

6.4. System User Functions (Level 4)

All Function described in this manual may be accessed from Level 4.

7. Main Menu Function Descriptions

7.1. F1 Measurements

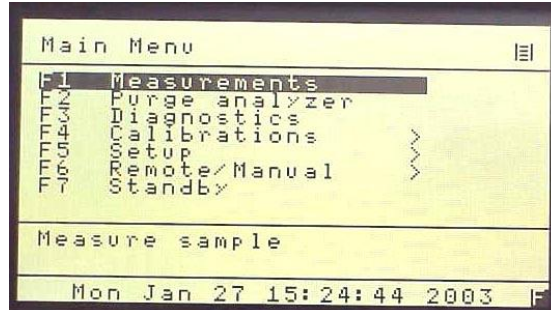

7.1.1. F1 NO or NOx Measurement

The measurements screen is activated by pressing F1 on the Main Menu screen. The NO/NOx content is displayed in ppm. Pressing F1 switches between measuring the sample gas for NOx or NO only. When the converter is off, only NO is measured. When the converter is on, NOx is measured.

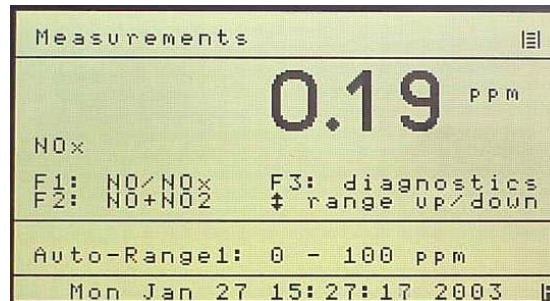

Measurement sScreen

7.1.2. F2 NO + NOx Measurement

The F2 function activates the “hold and sample” feature which allows the analyzer to automatically switch between NO and NOx measurement. The time duration for the sample read is set up in the Setup Menu. The analyzer will read and display the NO (converter is bypassed) value. At the predetermined time, it will switch to the NOx mode (through converter) and read and display the NOx value, while the last 15 second NO average is displayed. The top value will be “real time” values and will change between NO and NOx. The difference between the two average values is shown as NO2. All three values are sent to the analog and digital outputs.

Measurements		
NOx	0 . 1 7	PPM
NO	0 . 1 7	PPM
NO2	0 . 0 0	PPM
F1: NO/NOx		
Auto-Range1: 0 - 100 ppm		
Mon Jan 27 15:27:47 2003		

NO/NOx/NO2 Screen

7.1.3. F3 Diagnostics

F3 activates the diagnostic screen where pressures, flow rates, temperatures and EPC control voltages are displayed in real time. The units are psig, degrees C, ml/min. and voltage. Use the arrow key to switch between diagnostic screens.

Diagnostics I		
Temperatures: [°C]	Cell	: 66.27
	Diode	: -5.21
	Conv.	: 205.00
page 1/2		
	next screen	>
Mon Jan 27 15:31:47 2003		

First Diagnostics Screen

Diagnostics II		
EPC Coil: [V]	Sample:	5.76
	Ozone:	9.51
Pressures: [PSIG]	Sample:	3.85
	Air:	-0.05
Gas Flow: mL/Min	Sample:	60.24
	Air:	0.00
page 2/2		
<	previous screen	
Mon Jan 27 15:32:03 2003		

Second Diagnostics Screen

7.1.4. Range Select

With the arrow keys, the ranges 1 to 4 can be selected and locked in which will disable the auto range capability. Continue pressing the arrow keys will recycle the analyzer back to auto range. The range and/or auto range is displayed on the measurement screen. If the limits are exceeded while not in the auto range mode, a warning "Over Range" appears on the screen.

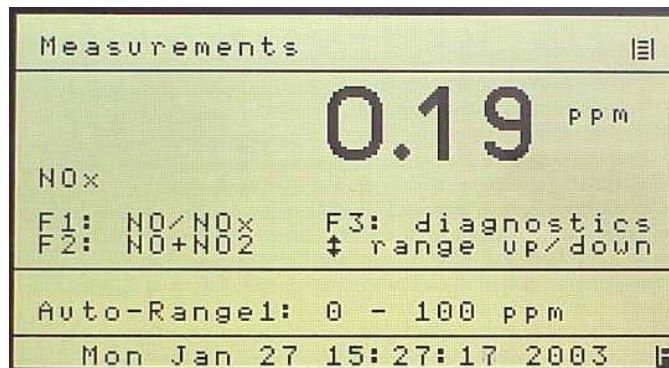

Set to Auto-Range

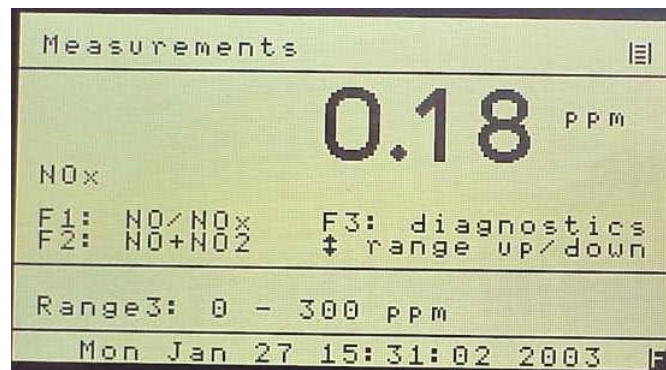

Analyzer Set to Range 3

7.2. F2 Purge Analyzer

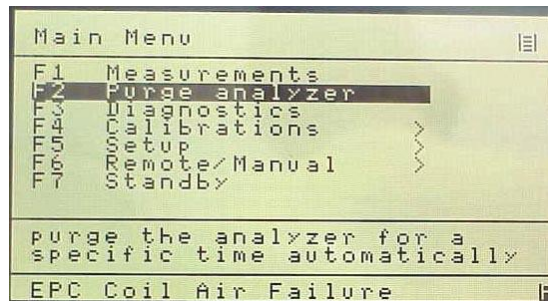

Main Menu (User Level 4)

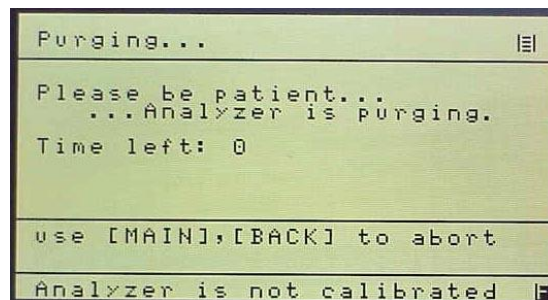

Purge Screen

F2 from the Main Menu activates the Purge (analyzer) function if equipped.

7.3. F3 Diagnostics

F3 from the Main Menu activates the Diagnostics function. As described in Section 7.1.3, F3 brings up the two diagnostics screens. The Diagnostics screens may be brought up from **EITHER** the Main Menu or the Measurements screen.

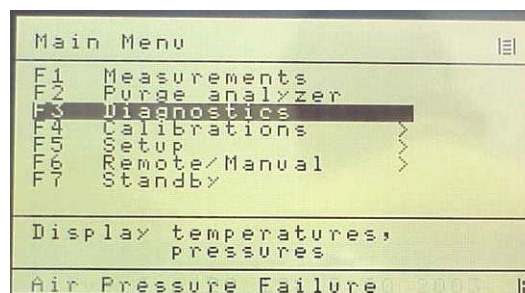

Main User Menu (Level 4)

7.4. F4 Calibrations

F4 from the Main Menu activates the Calibrations screen. Calibrations may be automatic or manual. Deviations can also be displayed. Calibration values can be reset to default values and the range to be calibrated can be changed.

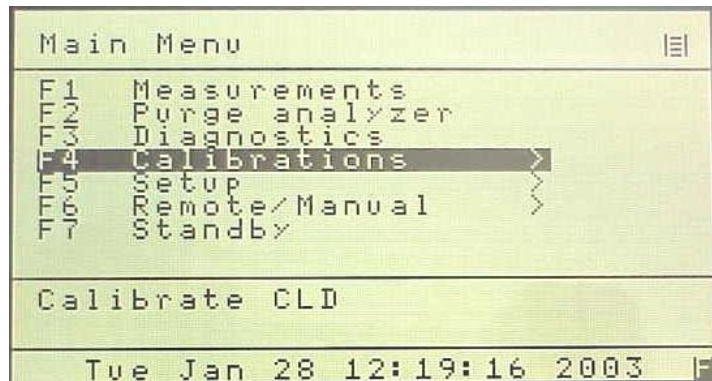

Main Menu (User Level 4)

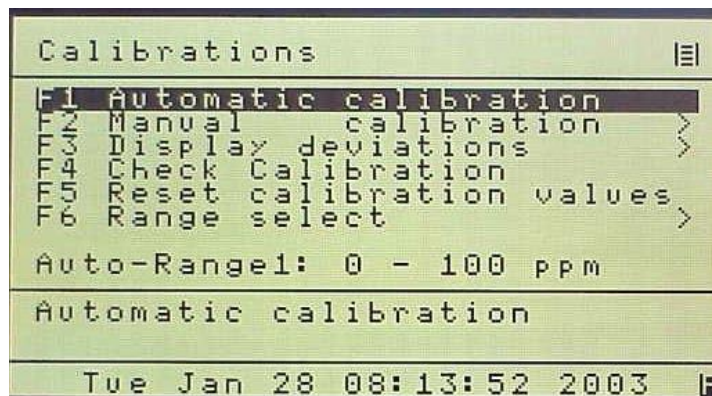

Calibration Screen

7.4.1. F1 Automatic Calibration

From the Calibrations screen, F1 starts automatic calibration. If auto range is selected, the actual range in use will be calibrated. Auto calibration works as follows: First zero gas is purged a certain time, called purge-time. Then the measurement begins. The measured value must be a minimum-time, called measuring-time and within an upper and a lower limit to be saved as new offset value. The maximum length of measuring time is 9 seconds. If the measured value was constant during calibration time, it is checked to determine if this value deviates from the preceding value. If the deviations are too large, a warning "Deviation error!" appears and the user can choose if the new value is saved or not. At last, the zero gas is flown a further time, verifying time, so it can be checked if the signal is still constant. All of these times can be changed. After zero gas calibration, the same happens with span gas. During auto calibration "Calibration in progress" is displayed. It also shows,

which gas is flowing and which time runs. When auto calibration has finished it is displayed. If the span value of the selected range is 0 (see section 5.6.1), then it will not be calibrated. If one range is calibrated and the span value for the lower ranges is zero, calibration parameters will be copied to this range. To calibrate all ranges with the same span gas, you must enter the gas concentration in the Span Gas Calibration screen for ALL RANGES. You must also calibrate each range. Offsets and scalors are NOT copied to other ranges.

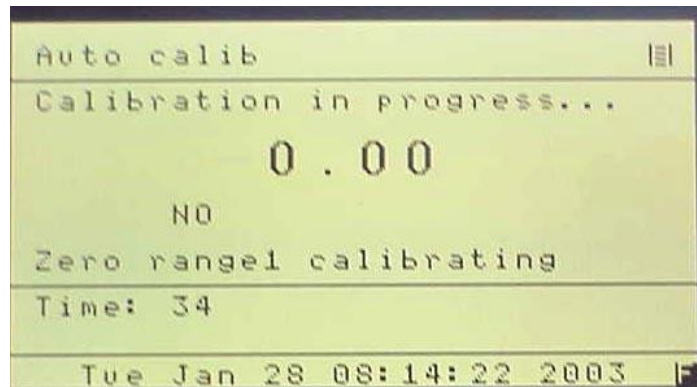

Auto Calibration Screen

7.4.2. F2 Manual Calibration

From the Calibration screen, F2 starts manual calibration. If auto range is selected, calibration is not possible, and the appropriate range can be selected. In the manual calibrations menu, three options are possible:

- F1 Flow zero gas
- F2 Flow span gas
- F3 Range select

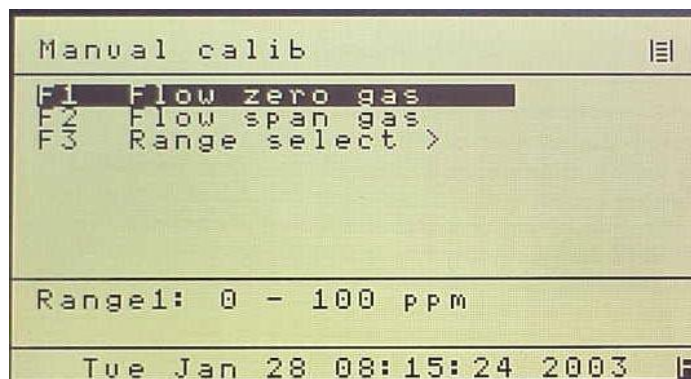

Manual Calibration Screen

When zero or span gas is flown, the measured value can be saved by pressing F1. If the screen is left by pressing the buttons "Main" or "Back", the measured value is not saved. Solenoids are closed by pressing F2. From the manual calibration menu, the range to calibrate can be chosen by pressing F3.

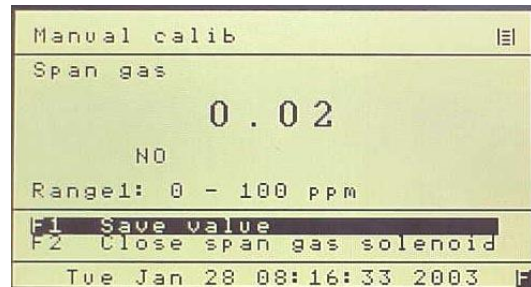
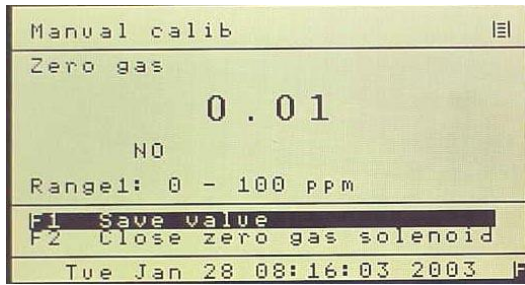

Manual Zero and Span Calibration Screens

5.4.3. F3 Display Deviations

After every calibration, the deviations are calculated for zero and for span gas.

- F1 shows zero gas deviations
- F2 shows span gas deviations
- F3 Deviations of zero gas during verifying
- F4 Deviations of span gas during verifying

F1 and F2 deviations are displayed in percent.

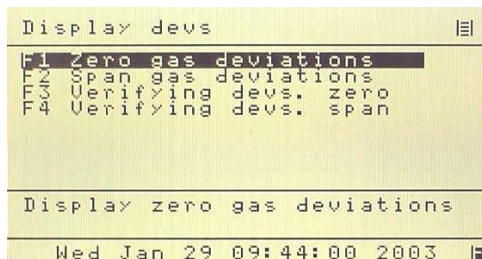

Deviation Screen

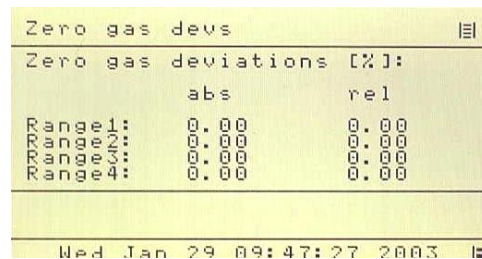

Zero Gas Deviations

During calibration there is a verification for zero and span gas. With option F3 and F4 you can view the deviations during the verification time. Absolute deviation is the absolute average difference from the saved value in ppm. Relative deviation is the absolute average difference in percent, related to the range limit.

7.4.3.1 Absolute Zero Gas Deviation

Absolute zero gas deviation is zero gas content calculated by the factory polynom related to the range limit of the calibrated range.

7.4.3.2. Relative Zero Gas Deviation

Relative zero gas deviation is the actual deviation minus the deviation of the previous calibration related to the range limit of the calibrated range.

7.4.3.3. Absolute Span Gas Deviation

Absolute span gas deviation is span gas bottle value minus span gas value calculated by the factory-polynom related to the range limit of the calibrated range.

7.4.3.4. Relative Span Gas Deviation

Relative span gas deviation is the actual deviation minus the deviation of the previous calibration related to the range limit of the calibrated range.

7.4.4. F4 Check Calibration

There is a default calibration. Pressing F4, activates an automatic zero and span check for verification.

7.4.4. F5 Reset Calibration Values

There is a default calibration. Pressing F5, a new screen appears and asks if the user is sure to reset calibration values to the default calibration values. F1 confirms and the calibration values are reset to default calibration values. F2 leaves this menu without resetting to default values. This function will overwrite all calibrations with factory values. Also the linearization polynom will be overwritten with the factory values.

7.4.5. F6 Range Select

This allows a range change to be activated from the calibration menu.

7.5. F5 Setup

From the Main Menu, F5 brings up the setup menu. Span gas concentrations, calibration settings, range limits, alarms, password, linearization, system and measure settings can be changed. The Setup menu begins as shown below. A description of each parameter is shown in the information box. NOTE: Use the down arrow key to obtain the additional setup parameters.

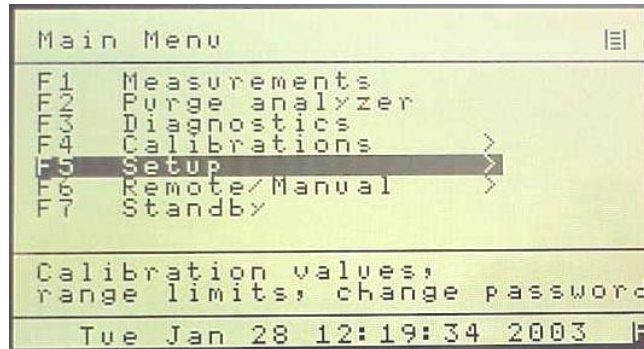

Main Menu (User Level 4)

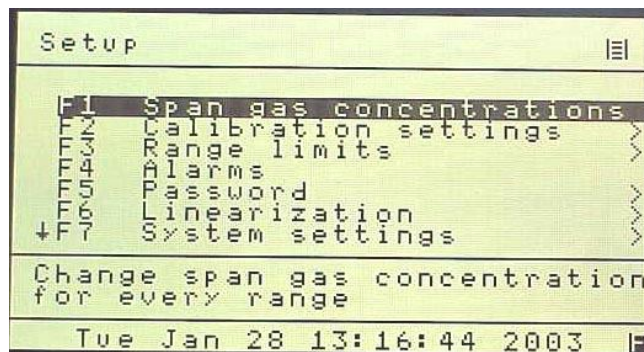

Setup Menu 1

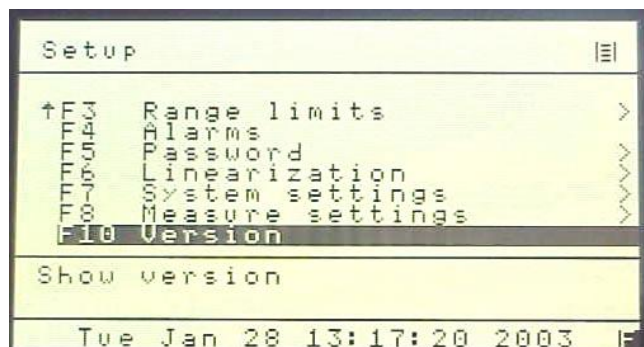

Setup Menu 2

7.5.1. F1 Span Gas Concentration

For calibration, it is necessary to input the concentration of the span gas in ppm. For every range, the span gas concentration can be changed. After pressing F1 in the setup menu, a screen appears in which changes can be made. Select with the cursor buttons the range to change. The selected field turns black. To change parameters, switch to parameter input mode by pressing the Enter key. The input cursor (horizontal bar under the first character) then appears in the active edit field (black background). The cursor can be positioned with the right and left cursor keys, and the value displayed (number or letter) can be changed with the up and down cursor keys or entered directly. Every input has to be concluded by pressing the Enter key again. Then the input cursor disappears and a new range can be selected. The changes are saved by leaving the screen by pressing "Main" or "Back". At the right side of the screen, the range limits of the 4 ranges are displayed. They cannot be changed in this screen.

Span gas conc.	range limits
Range1: 25.200	30
Range2: 95.200	100
Range3: 265.100	300
Range4: 2925.700	3000

Change Span Gas Settings

7.5.2. F2 Calibration Settings

In the calibration settings menu, times, deviations and methods can be changed.

F1	Times
F2	Measuring deviations
F3	Deviations
F4	Calib. via valves
F5	Calib. via probe

Change purge-, measuring-,
verifying-, calibration time

Wed Jan 29 11:08:11 2003

Change Auto Calibration Settings

7.5.2.1 F1 Times

There are four times (in seconds) for auto calibration that can be changed. Purge, measuring, calibration and verifying time. Changes are made and saved as above.

7.5.2.2 F2 Measuring Deviations

During auto calibration, the measured value is only saved if it is within a certain time within an upper and a lower limit. These two limits format a working window. In the setup menu the deviation is in percent.

7.5.2.3 F3 Deviations

Here you can change absolute and relative deviation in percent. After auto calibration, it is checked to assure the deviations are within this limit. If the deviations are not in this limit, a warning "Deviation error!" appears.

7.5.2.4 F4 Calibrations via Valves

Calibrations can be made by using the solenoids for zero and span gas or by using the pump. Calibration via valves means that the zero gas is flown by the zero gas solenoid and the span gas is flown by the span gas solenoid.

7.5.2.5 F5 Calibration via Probe

Calibration via probe means that the zero and the sample gas is flown by the pump, the solenoids for zero and span gas are not used.

7.5.3. F3 Range Limits

There are 4 different ranges. The user can define the upper range limits in ppm.

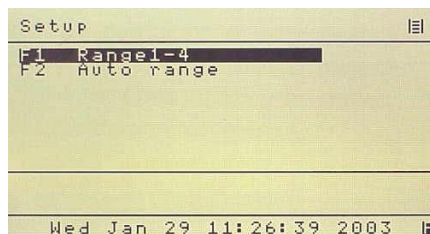

Change Range Limits

7.5.3.1 F1 Range 1-4 (Change Upper Range Limits)

In this menu the upper range limits can be changed. The new settings are saved by pressing MAIN or BACK. The auto range limits are automatically adapted. This means that if the upper range limit of range 1 for example has reached 90% of the upper range limit in the auto range mode, it is switched automatically to the second range.

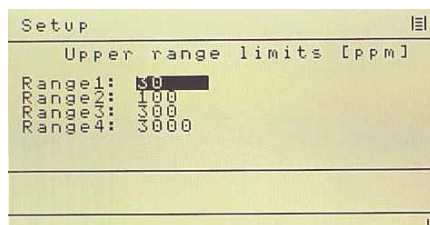

Change Upper Range Limits

7.5.3.2 F2 Change Auto Range Limits

Although the auto range limits are adapted automatically, it is possible to define them manually. Up means the value when the next higher range is selected in auto range mode, down the value when the next lower range is selected.

Setup		down	up [ppm]
Range1:			27
Range2:	27		90
Range3:	90		270
Range4:	270		

Change Auto Range Limits

7.5.4. F4 Alarms

Error reports are always displayed in the lowest line of the screen. There are two pressures, three temperatures, one concentration and two voltages with alarm limits that can be defined. The user can define the range limits and, if exceeded, will display an error-message.

Alarms I			
-Temp:	Cell :	Min	Max
[°C]	Diode :	65.00	67.00
	Conv. :	-5.50	-4.50
		204.00	207.00
F1 - next page		page 1/2	
Tue Jan 28 14:10:36 2003			

Set Temperature Alarms

Alarms II			
-Conc. alarms:		Min	Max
		500	750
-Press:	Sample	3.82	4.88
[PSIG]	Air	14.00	16.00
-EPC:	Sample	1.00	5.00
[V]	Air	1.00	7.00
F1 - previous page		page 2/2	
Air Pressure Failure			

Set Concentration, Pressure and Voltage Alarms

7.5.5. F5 Password

After turning on the analyzer, you are in access level 1. To change the access level or to change the passwords, press F5 (Setup) in the main menu and Press F5 (Password) again. The following screen appears:

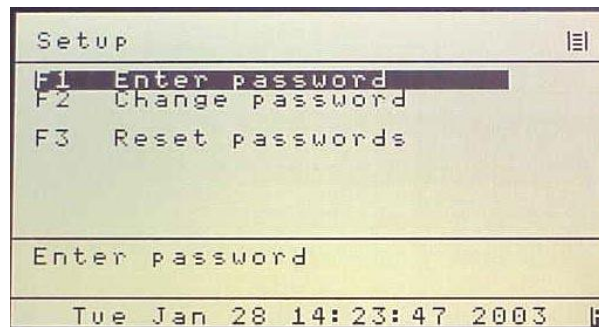

Enter / Change Password

7.5.5.1 F1 Enter Password

To change access level, press F1. The following screen appears:



Access Level Screen

F1 to F4 selects an access level. Move the cursor to the access level to be modified. You must enter the correct password for the access level desired. The passwords for the various operation levels consist of three numbers that must to be entered on the numeric keypad. If the code word is incorrect, you are asked to re-enter the codeword.

+ **IMPORTANT TIP:** When a new analyzer is powered up, it defaults to access level 1 (User). To operate ALL parameters and gain complete access, select F4. Press the Enter key twice and enter 444.

7.5.5.2 F2 Change Password

The passwords can only be changed, if you are in access level 4. After F2, enter your new 3 digit passwords.

+ **IMPORTANT TIP:** You MUST remember and record this new password. If this is lost, you will need to consult the factory for the default password !!

7.5.5.3 F3 Reset Passwords

The passwords can only be changed, if you are in access level 4. Reset passwords will revert back to the factory defaults.

7.5.6. F6 Linearization

Pressing F6 on the Setup screen brings up the Linearization screen. The analyzer can be linearized by a polynomial with 5 coefficients. By pressing F1, these 5 coefficients can be changed for each range. By pressing F2, the raw value can be displayed. This is the value before linearization and offset span correction. There are two values on the screen: The value at the top is the linearized, offset-span-corrected value, and the other value is the raw-value.

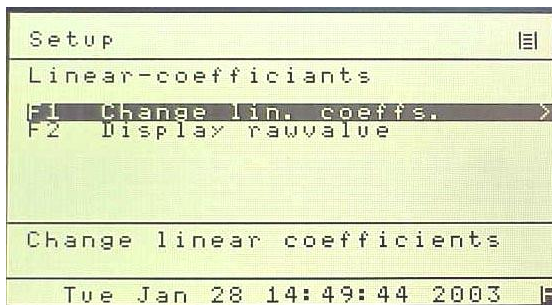

Linearization Screen Linearization

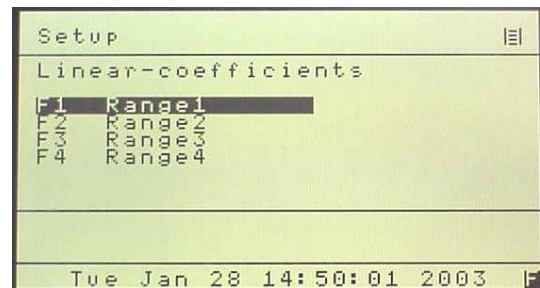

Coefficients Range Select

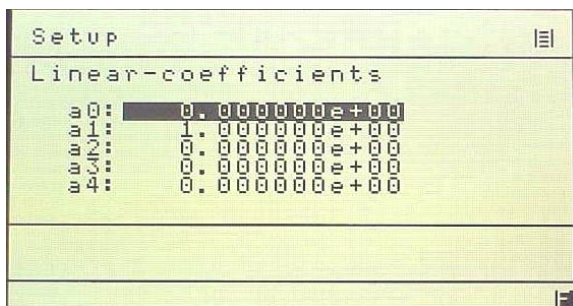

Change Linearization Coefficients
of Selected Range

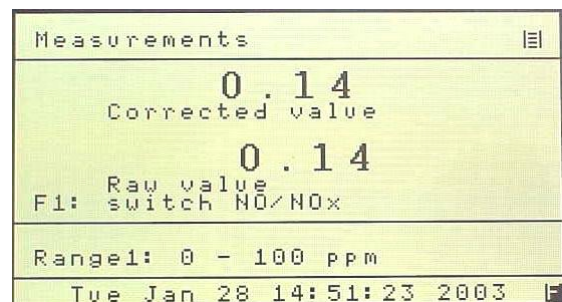

Example of Linearized and
Raw Data with F2

7.5.7. F7 System Settings

This screen allows all the system settings to be displayed and modified.

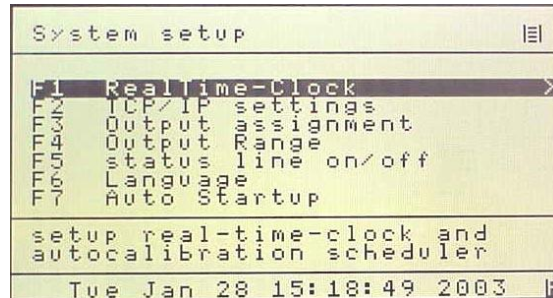

System Setup Screen

7.5.7.1 F1 Real Time Clock

This brings up the clock time set screen, auto cal and auto cal enable screens.

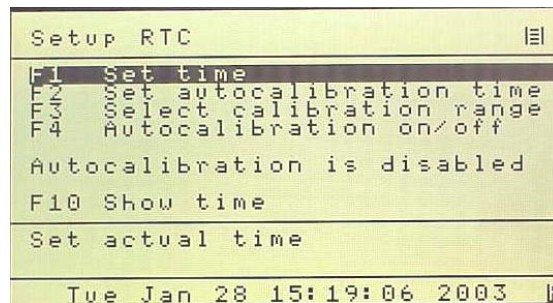

Clock and Timing Setup Screen

F1 brings up the clock set screen

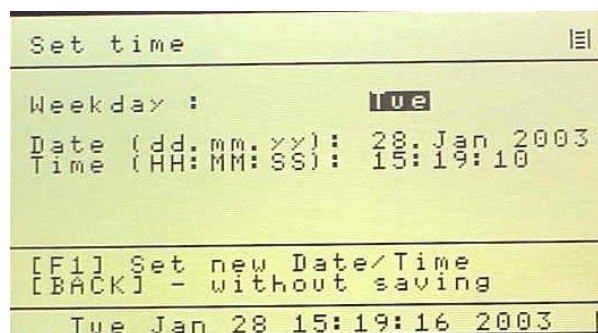

Set Clock Screen

The current time may be set by using the cursor to highlight the entry and using the numeric keys to change the values.

F2 brings up the auto cal time set. As above, the date and times can be set by using the cursor to highlight the entry and using the numeric keys to change the values. F3 Sets autocalibration ranges.

```

schedule                                     |
-----
Starttime : 15: 0: 0 on Tue
Date      : 28. Jan 2003
Every    :      1  hour(s).
F1 - change to weekly
F2 - change to daily
F3 - change to hourly
-----
press MAIN or BACK to exit
F1, F2, F3 to save changes
-----
Tue Jan 28 15:19:33 2003 |

```

Set Auto Cal Timing

```

Range selection                               |
-----
Enter Range [0..4]: 2
Converter Mode      :
-----
If 0 all ranges will be
used for autocalibration
-----
Tue Jan 28 15:20:00 2003 |

```

Set Auto Cal Ranges

```

Setup RTC                                     |
-----
F1 Set time
F2 Set autocalibration time
F3 select calibration range
F4 Autocalibration on/off
-----
Autocalibration is disabled
F10 Show time
-----
enable/disable
autocalibration
-----
Air Pressure Failure |

```

F4 Toggles Auto Cal ON of OFF.

7.5.7.2 F2 Displays TCP/IP Address

```

TCP/IP setup
IP-address: 192.000.000.229
Netmask   : 255.255.255.000
Port      : 7700
WinIfPort : 2000

HWaddress : 00.E0.4B.01.9D.D4

enter IP-Address
take effect after reboot

Tue Jan 28 15:48:23 2003

```

TCP/IP Address

7.5.7.3 F3 Displays Output Signal Assignments*(Used to Adjust Analog Output Channels)*

```

assignment
Output  Signal      Error
       on AOut
1      Realtime    Off
4Out0  off
4Out1  off
4Out2  off

Air Pressure Failure

```

Output Assignments

7.5.7.4 F4 Displays Output Ranges*(Used to Adjust Scale of Analog Output Channels)*

```

output ranges
Output  Limit  Mode
       lower upper
1      0      0      U
4Out0  0      0      mA
4Out1  0      0      mA

enter 0 in both fields to
use the default range.

Air Pressure Failure

```

Output Ranges

7.5.7.5 F5 Turns Status Line On or Off

The status line displays the AK Protocol action on the top line of the display.

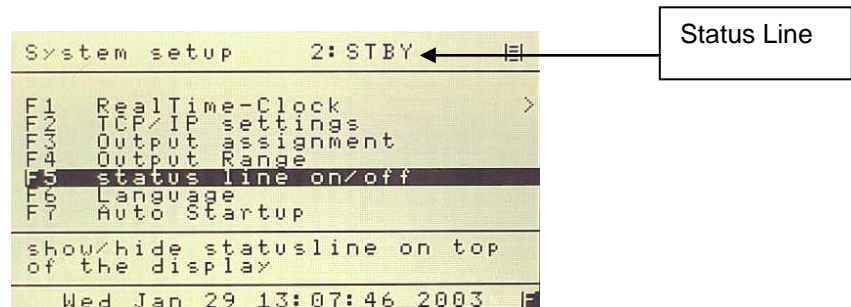
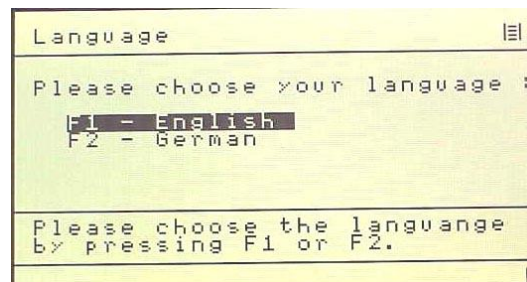
**7.5.7.6 F6 Language**

Select Language

7.5.7.7 F7 Automatic Setup

This screen brings up the automatic startup parameters. If activated, the analyzer will automatically start up the autocalibration cycle upon power on. The function is toggled on and off with the Enter key. The cycle timing, number of cals, range and NO/Nox mode may be set. After calibration, the analyzer enters the sample mode and outputs a digital signal. This is very useful in unattended applications.

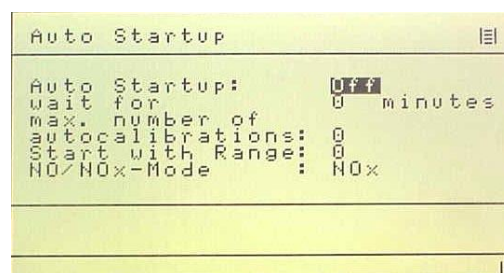

Automatic Startup Parameters

7.5.8. F8 Measure Settings

This screen allows several of the system settings to be displayed and modified.

```

Measure setup
-----
F1 Set NO2-mode times
F2 Converter efficiency
F3 Lowpass filter Tc
F4 Purge time

setup_purge- and measure-
time for dual mode

Wed Jan 29 13:26:12 2003
  
```

Menu Settings Screen

7.5.8.1 F1 Set NO2 Mode Times

```

set times
-----
purge time : 5
measure time : 5

wait time before
measuring

Wed Jan 29 13:26:31 2003
  
```

Set NO2 Purge and Measure Time

7.5.8.2 F2 Converter Efficiency

F2 on the Menu Settings screen allows the NO to NO2 converter efficiency to be set to the actual measured converter efficiency. A value of 100% equals 1.00. F2 will prompt the operator through the NOx efficiency test using a NOx generator.

```

Setup
-----
Converter efficiency
current : 1.00
F1 - run auto calculation

enter/show converter
efficiency parameter

EPC Coil Air Failure
  
```

Set Converter Efficiency

7.5.8.3 F3 Low Pass Filter Time Constant

F3 on the Menu Settings screen allows the software time constant to be set between 1 and 60 seconds. This is very useful in eliminating noise when measuring low level concentrations.

```

Lowpass filter
-----
enter time constant of sample
lowpass filter :
Time constant (0..60): 1
used for calculating
the sliding average.
-----
Wed Jan 29 13:26:57 2003
  
```

Set Time Constant

7.5.8.4 F4 Purge Time

F4 on the Menu Settings screen the sets the purge time before continuing with a zero or span calibration.

```

Purge Time
-----
Purge time : 20
(this time is different to
the one entered in
calibration time setup)
-----
Wed Jan 29 13:27:07 2003
  
```

Set Purge Time

7.5.10. F10 Displays the Current Analyzer and Software Versions

This displays the analyzer's information, including the factory recommended air and sample pressure settings.

```

Version
-----
Model : 600 CLD
S/N : 21N06004
Air pres.: 15 PSI
Sample pres.: 3.85 PSI
Software version >
-----
Tue Jan 28 13:17:38 2003
  
```

Analyzer Information Version

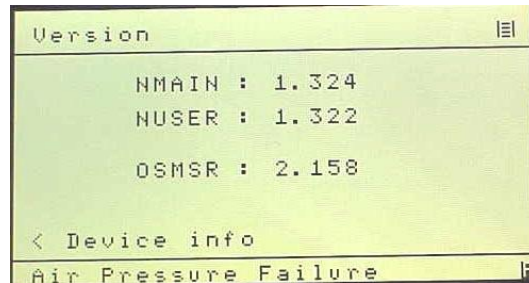

Software Version

7.6. F7 Remote / Manual Control

The analyzer can be remote-controlled by either a master computer or via contact closures. The TCP/IP and serial communication fully corresponds to the specifications of the AK protocol. To change remote/manual control, press F6 in the main menu. This toggles between remote and manual control.

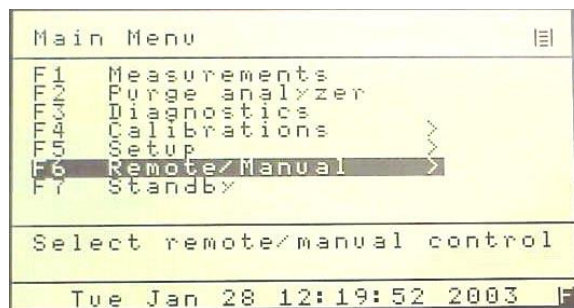

Main Menu (User Level 4)

7.7. F8 Standby

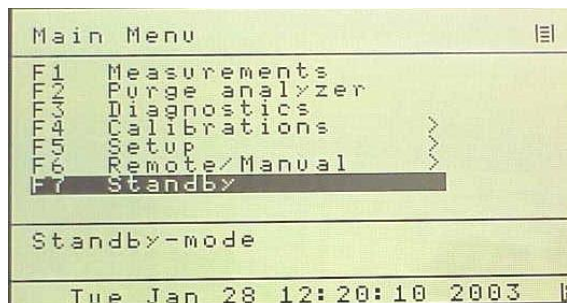

Main Menu (User Level 4)

In Standby mode, pump is turned off and the solenoids are closed. The CAI logo is displayed.

8. Analyzer Components

8.1. Rear Panel

The following details the rear panel connections:

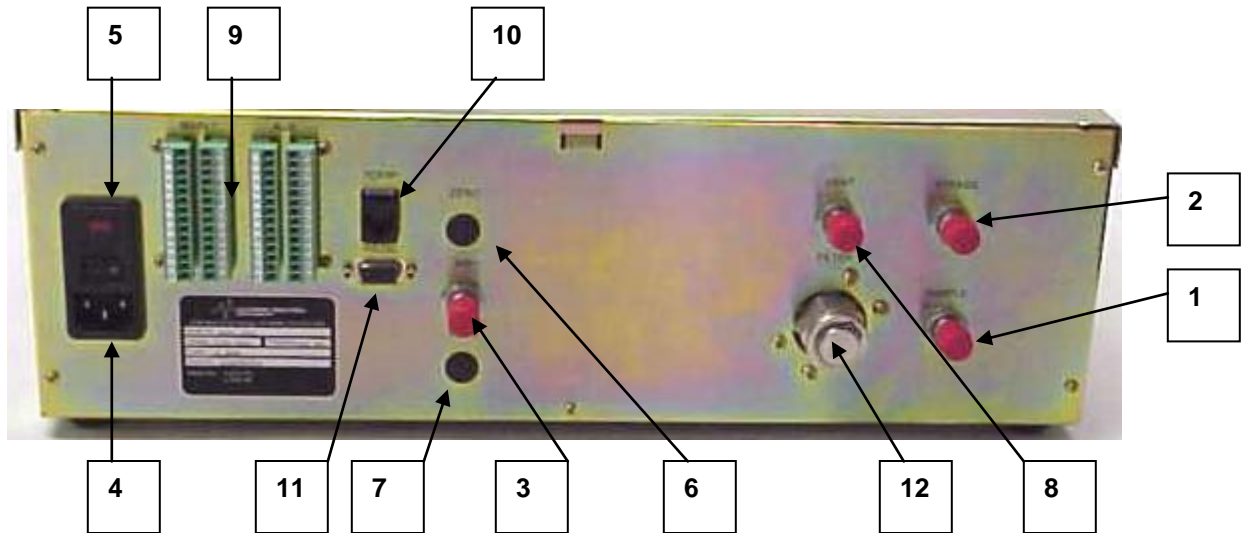

Figure 32: Rear Panel

1. **Sample Gas Inlet:** Feeds sample gas to the analyzer. ¼ Inch Tube.
2. **Sample Gas Bypass Outlet (Vent):** Exhaust for sample. ¼ Inch Tube.
3. **Ozone Air Inlet:** For feeding hydrocarbon free air or oxygen to the ozone generator.
4. **Power Entry Module:** Power connection, power switch, fuse compartment (2 Amp).
5. **Rear Panel Power ON/OFF Switch:** Turns ON/OFF line power to instrument.
6. **Zero Gas Inlet:** For feeding hydrocarbon free zero air to the analyzer.
7. **Span Gas Inlet:** For feeding calibration gas to the analyzer.
8. **Vent:** Exhaust from reaction chamber, ¼ inch tube fitting.
9. **Output Connectors:** Analog Outputs and Remote Functions.
10. **TCP/IP Connection:** Connect Network Connector.
11. **Serial Connector:** Connect Serial Connector
12. **Filter:** Analyzer Filter Housing

8.1.1. Main Connector (Standard 28 Pin Connector)

<u>Pin</u>	<u>Signal</u>	<u>Function</u>	<u>Pin</u>	<u>Signal</u>	<u>Function</u>
1	Analog Output	Ground (Analog)	15	Digital Input	Control Range 3
2	Analog Output	Realtime	16	Digital Input	Control Range 4
3	Analog Output	NO	17	Digital Input	Auto Cal
4	Analog Output	NOx	18	Digital Input	Calibrate
5	Analog Output	NO2	19	Digital Input	Zero
6	Digital Output	Ground (Digital)	20	Digital Input	Span
7	Digital Output	Sense AutoRange	21	Digital Input	Pump
8	Digital Output	Sense Range 1	22	Digital Input	Zero Gas Flow
9	Digital Output	Sense Range 2	23	Digital Output	Span Gas Flow
10	Digital Output	Sense Range 3	24	Digital Output	Sample Gas Flow
11	Digital Output	Sense Range 4	25	Digital Output	Local/Remote
12	Digital Input	Set Auto Range	26	Digital Output	Read Cal Mode
13	Digital Input	Control Range 1	27	Digital Output	Reserved
14	Digital Input	Control Range 2	28	Digital Output	Reserved

8.1.2. Auxiliary Connector (Standard 28 Pin Connector)

<u>Pin</u>	<u>Signal</u>	<u>Function</u>	<u>Pin</u>	<u>Signal</u>	<u>Function</u>
1	Analog Input	Ground	15	Digital Output	Ground (Alarm)
2	Analog Input	External Analog 1	16	Digital Output	Calibrate Alarm 1
3	Analog Input	External Analog 2	17	Digital Output	Reserved
4	Analog Input	Spare Analog	18	Digital Output	Reserved
5	Analog Input	Spare Analog	19	Digital Output	Reserved
6	Digital Output	Ground (Alarm)	20	Digital Output	Read Wet Mode
7	Digital Output	General Alarm	21	Digital Output	Read Overflow
8	Digital Output	Ch 1 Conc Alarm	22	Digital Output	Read NO Mode
9	Digital Output	Ch 2 Conc Alarm	23	Digital Input	Set Wet Mode
10	Digital Output	Reserved	24	Digital Input	Set Overflow Mode
11	Digital Output	Reserved	25	Digital Input	Set NO Mode
12	Digital Input	Reserved	26	DI/DO	Spare
13	Digital Input	Reserved	27	DI/DO	Spare
14	Digital Input	Reserved	28	DI/DO	Spare

8.1.3. Digital Outputs – RS-232 (Standard 9 Pin DIN Connector)

<u>Pin</u>	<u>Function</u>
1	DCD Carrier Detect
2	RxD Receive Data
3	TxD Transmit Data
4	DTR Data Terminal Ready
5	Ground
6	DSR Data Set Ready
7	RTS Ready to Send
8	CTS Clear to Send
9	RI Ring Indicator

8.1.4. Digital Outputs – TCP/IP (8 Pin RJ-47 Connector)

<u>Pin</u>	<u>Function</u>
1	TDX+
2	TDX-
3	RXD+
4	Open
5	Open
6	RXD-
7	LNLED
8	LNLED

+ **IMPORTANT TIP:** For direct connect to a PC a crossover cable is required. Connection to a hub requires a straight cable.

8.2. Internal Component Locations

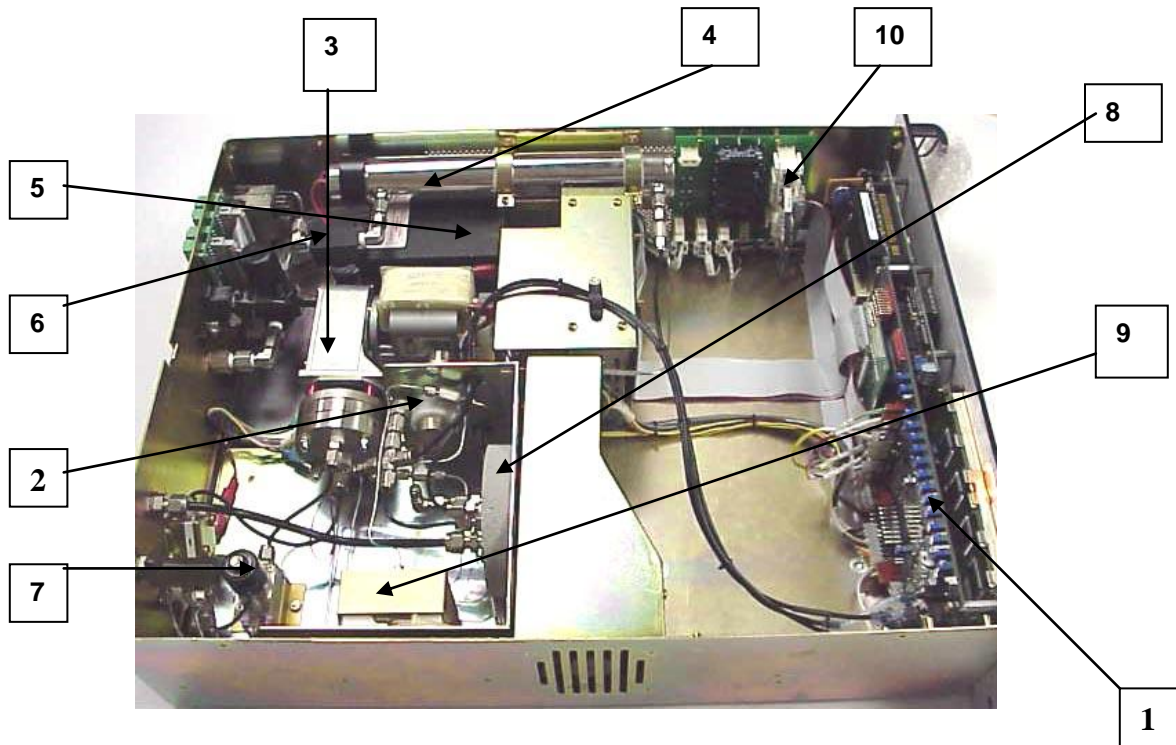

Major Internal Components

1. **Electronics:** Includes instrument electronics. (See Main Electronic Board)
2. **NO/NO_x Solenoid Valve:** Switches flow between the NO and NO_x mode.
3. **Optional Internal Sample Pump:** Provides sample to analyzer.
4. **Ozonator:** Contains UV Lamp.
5. **Ozonator High Voltage Supply:** Produces High Voltage to UV lamp.
6. **Proportional Flow Pressure Regulator:** Regulates flow of ozone.
7. **Proportional Flow Pressure Regulator:** Regulates flow of sample.
9. **Reaction Chamber & Detector Assembly:** See Figure 8.
10. **NO/NO_x Converter:** Converts NO₂ to NO for total NO_x
11. **Relay Control Board:** Provides AC Voltage to Heaters, Pump and UV Transformer.

8.3. Main Electronics Board (Potentiometers)

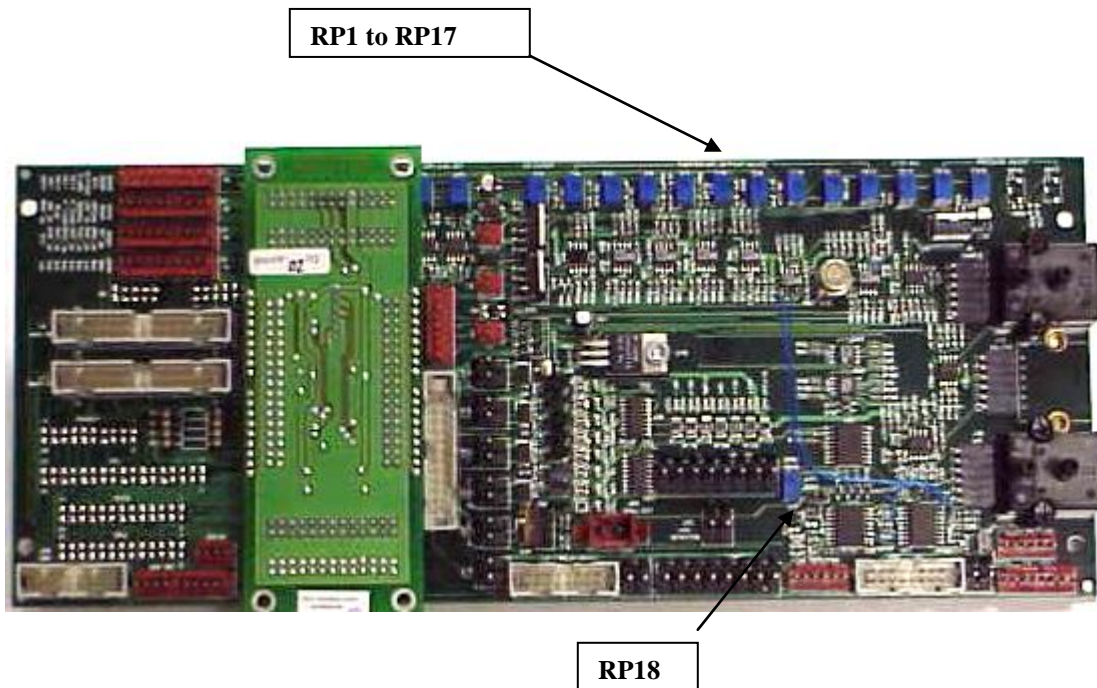

Main Electronic Board Potentiometers

RP1	: EPC 9.5V Sample Set	RP10	: Chiller Zero Temp Set
RP2	: EPC 9.5V Air Set	RP11	: Chiller Span Temp Set
RP3	: O3 Cutoff	RP12	: Chiller Temp Set
RP4	: Cell Temp Set	RP13	: 12VDC Adjust
RP5	: Oven Temp Set	RP14	: Sample Pressure Set
RP6	: Pump Temp Set	RP15	: Air Pressure Set
RP7	: Converter Temp Set	RP16	: Not Used
RP8	: O2 Temp Set	RP17	: Not Used
RP9	: NH3 Temp Set	RP18	: Coarse Zero Adjust

NOTE: Potentiometers are clearly labeled on both sides of the PCB.

8.4. Main Electronics Board (Connectors)

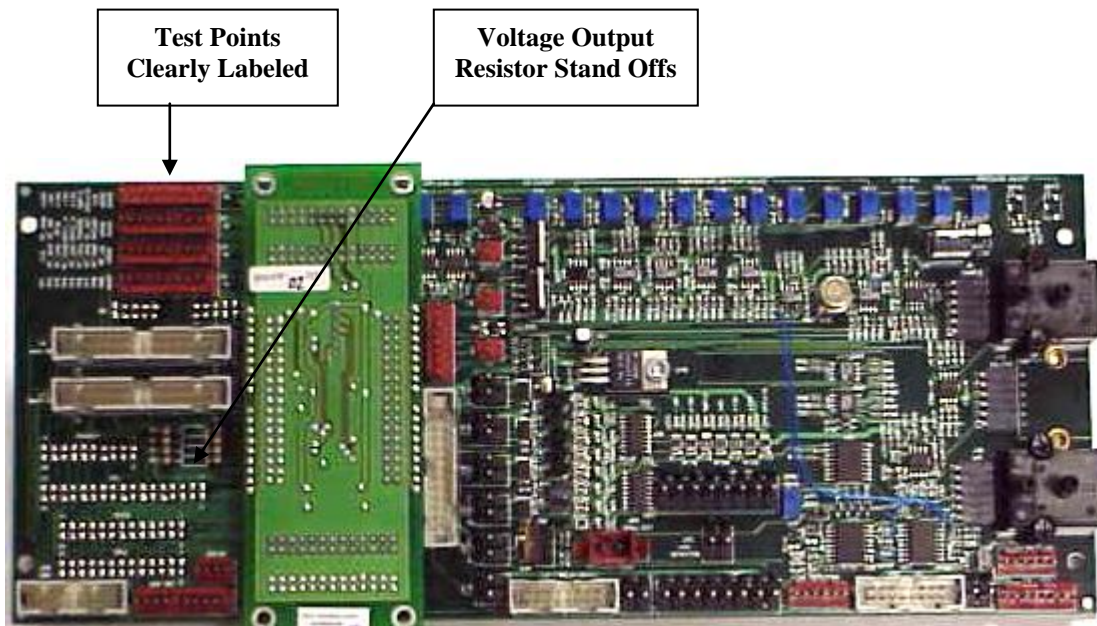

Main Electronic Board Connectors

J1 : Test Points	J2 : Test Points
J3 : Test Points	J4 : EPC Air Valve
J5 : Test Points	J6 : Digital Output 2 (DIDO Board)
J7 : EPC Sample	J8 : Sample Transducer
J9 : Aux Back Panel	J10 : Spare Digital Output
J11 : Diluter	J12 : Main Back Panel
J13 : Digital Input 2	J14 : NO/NOx Valve
J15 : Diluter Transducer	J16 : Span Valve
J17 : Digital Output 1	J18 : Zero
J19 : Aux Power	J20 : Air Transducer
J21 : Sample Overflow Valve	J22 : Daisy Chain Input 1 (DIDO Board)
J23 : Wet/Dry Valve	J24 : Chiller Out
J25 : + 5 Volt Detector	J26 : Spare Analog Input
J27 : Chiller Temp Sense	J28 : Spare Back Panel
J29 : Spare Digital Input	J30 : Daisy Chain Output (DIDO Board)
J31 : Fan Power	J32 : Relay Board
J33 : Chiller Power	J34 : Power
J35 : Detector	J36 : O2 Detector
J37 : Thermocouple	J38 : RTD
JP1 : PGA Zero	

NOTE: Connections are clearly labeled on the PCB

--

8.5. Reaction Chamber

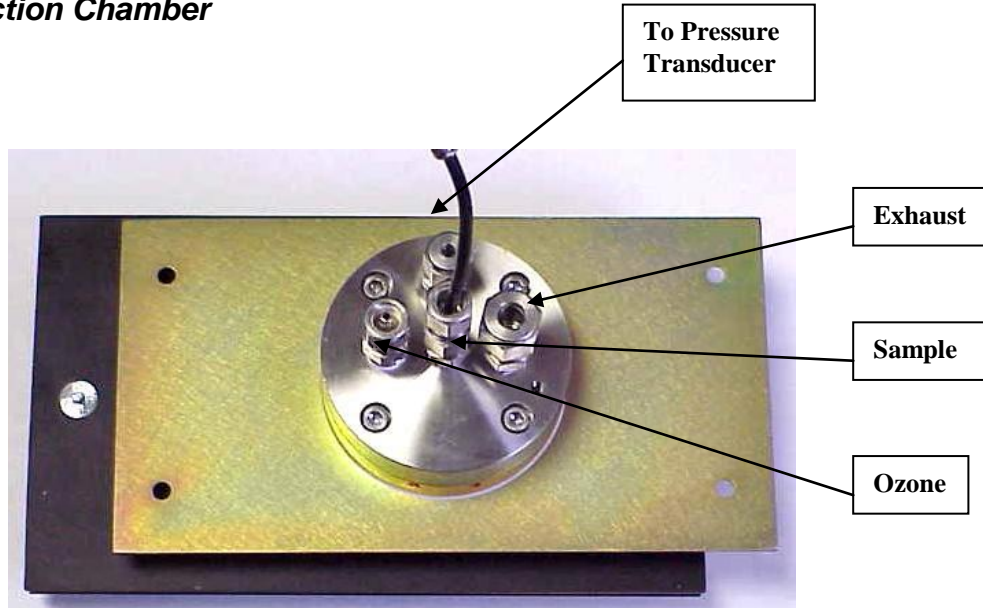

Reaction Chamber Assembly (Oven Side)

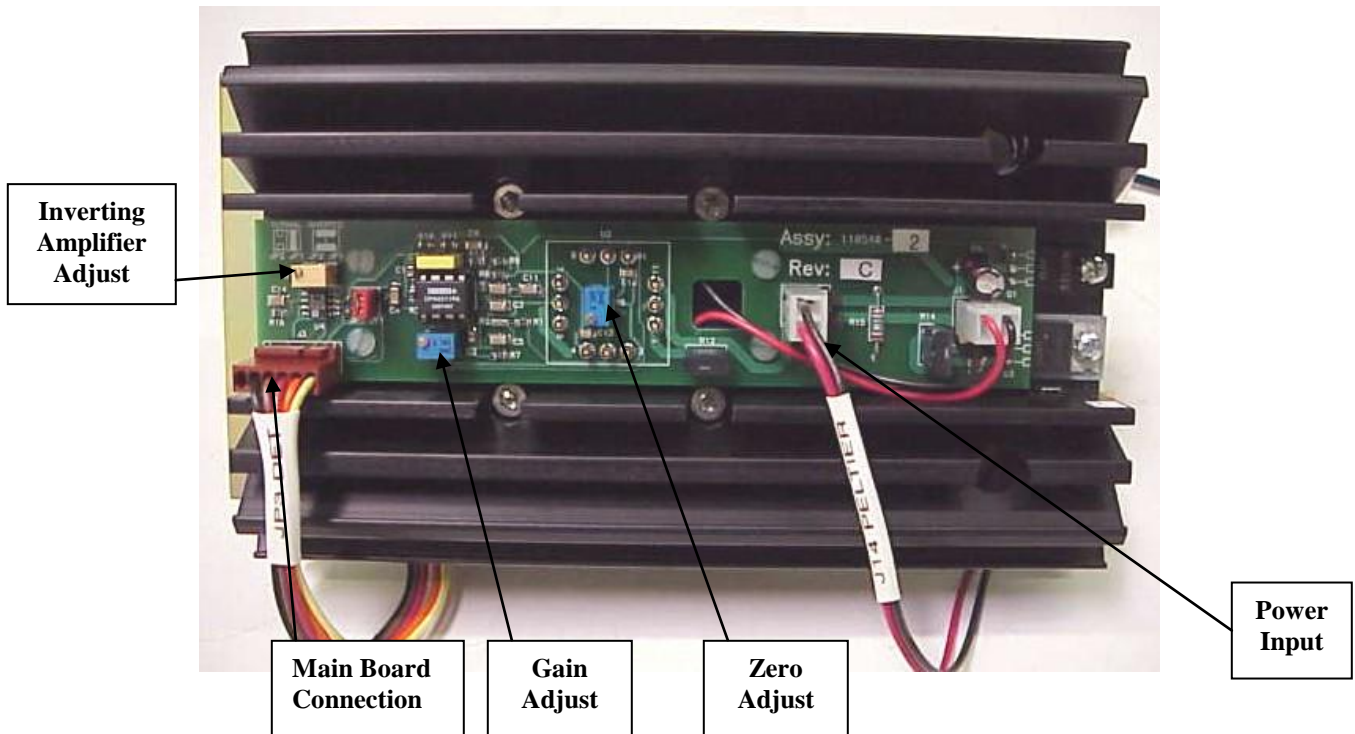

Reaction Chamber Pre-Amplifier

8.6. Relay Board Connections

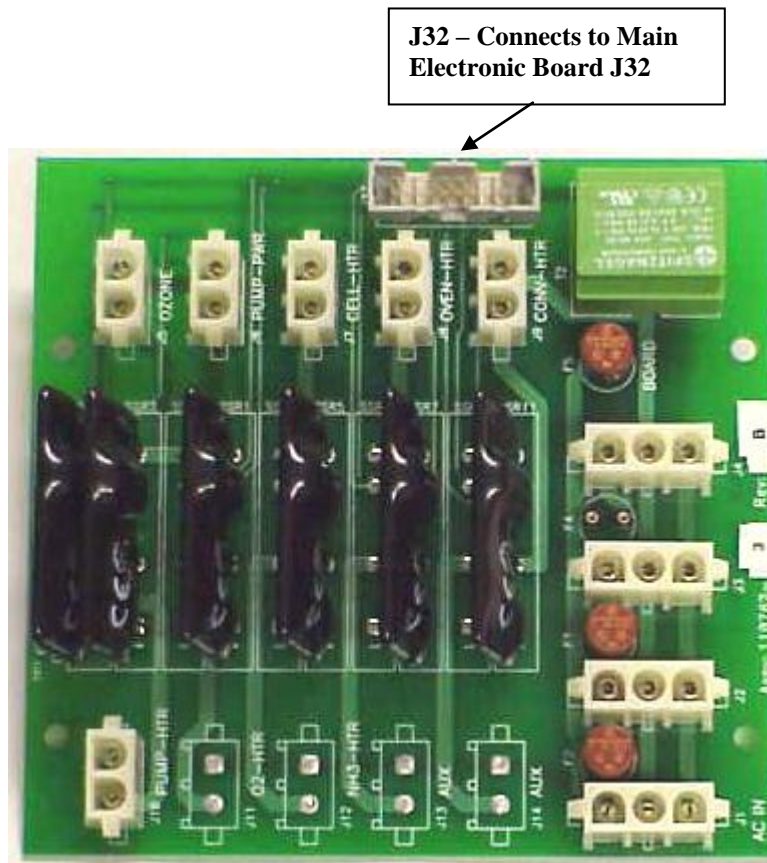

Relay Board Connections

J1 : AC Input	J2 : Power Supply 1
J3 : Power Supply 2	J4 : Power Supply 3
J5 : Ozone Lamp	J6 : Pump Power
J7 : Cell Heater	J8 : Oven Heater
J9 : Converter Heater	J10 : Pump Heater
J11 : Optional O2 Heater	J12 : Optional NH3 Heater
J13 : Aux	J14 : Aux

9. Operation

9.1. Preparation for Operation

Check that the external plumbing and wiring have been connected correctly, as described in this manual.

NOTE: The internal ozone generator requires approximately 1 hour of continuous operation for the analyzer to achieve full zero and span calibration stability. A pressure switch will turn off the ozonator when air or oxygen is not present at the analyzer rear panel.

9.2. Operation

1. **Power On:** Turn ON the power switch on the rear panel. The digital display should illuminate.
2. **Introduce Ozone Supply (Air or O²):** Adjust the cylinder output pressure to 25 PSIG. The internal air pressure is factory set to deliver the air pressure required for optimum analyzer performance as indicated in the factory settings screen.
3. **Air or O² Pressure Settings:** Check the air pressure setting by referring to the diagnostic screen to check air pressure. The pressure should read as indicated in the factory settings screen.
4. **Zero Adjustment:** Flow zero gas through the instrument by selecting the calibration screen and select either manual or auto calibrate.. **NOTE:** The instrument may also be operated by an external computer or by remote contact closures.
5. **Span Adjustment:** Flow span gas through the instrument by selecting the calibration screen and select either manual or auto calibrate.. **NOTE:** The instrument may also be operated by an external computer or by remote contact closures. **NOTE:** The correct calibration gas values must be entered. The instrument is available from the factory with four ranges.
6. **NO/NO_x Function:** The analyzer switches the NO_x converter in and out of the sample stream and is controlled from the measurement screen. In the NO mode, the sample by-passes the converter and the resultant analysis produces the value of NO (Only) in the sample. In the NO_x mode, the sample passes through converter and the resultant analysis produces the value of NO_x (NO + NO₂) in the sample. The NO mode may be switched in and out remotely by a contact closure or computer. Remote control wiring is terminated in the rear panel connector. (See Appendix).

7. **Sample Pressure Check:** With sample gas flowing through the instrument, check the sample pressure setting by referring to the diagnostic screen. The sample pressure should read as indicated in the factory pressure settings screen.
8. **Optional Rear Mounted After NO_x Converter Chiller:** With gas flowing through the instrument at 85 to 100 degrees C, the sample is passed through the heated NO₂ to NO converter, the rear mounted chiller and to the reaction chamber. This allows for a dry measurement.

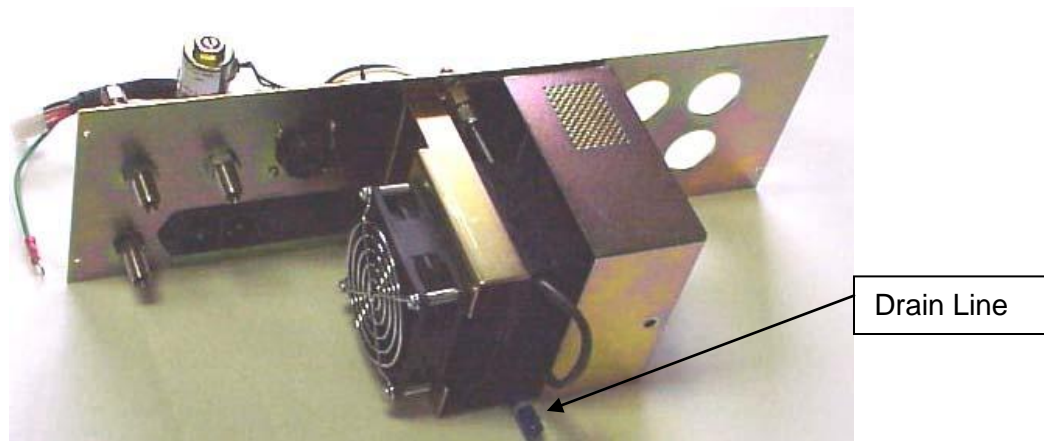

This chiller is self-contained and has a single temperature adjust potentiometer which is accessible through the electronics cover. The chiller has a ¼ inch drain, which MUST be held at a “bleed” pressure, either through an external peristaltic pump or needle valve. Drain flow rate of 10 ml/min should be sent to facility drain. An optional Wet/Dry switch is available.

CAUTION: Never supply a “wet” sample to a cold analyzer as damage may occur.

9. **Sample Pump:** : If the analyzer is supplied with the optional internal heated sample pump, it is always on in the measure mode. It is turned off during calibration and may be manually turned off by putting the analyzer in standby.
10. **Heated Sample Line:** Make certain the heated sample line is up to temperature and flushed before connecting to the analyzer sample inlet.
11. **Instrument Power:** Turn instrument power on and allow the oven temperature to stabilize before turning on the sample pump and/or connecting the heated sample line.

12. **Sampling System:** Prepare and check the sample system. Check the sample pressure as indicated in the factory settings screen.

13. **Air or O² Pressure:** Check the Air/O² pressure for proper setting as indicated in the factory setting screen. Readjust internal pressure as required. Note: Cylinder pressure should be set at 25 PSIG.

14. **Zero & Span Calibration:** Zero and span adjustment should be checked every 24 hours by either manual or automatic calibrations.

15. **Reaction Chamber Assembly:** Dust, water droplets, or mist entering the reaction chamber assembly may cause drift due to contamination. If the calibration procedures fails to bring the instrument to zero, check the chamber for contamination.

9.3. Shut Down Procedure

1. Turn off the zero, span and air/O₂ cylinders.
2. If the analyzer contains the optional internal heated sample pump, disconnect the sample line from the rear inlet port. Do **NOT** turn off the sample pump or analyzer power at this point.
3. Allow the analyzer to draw in room air for approximately 5 minutes. This will flush out any remaining sample which may cause condensation as the analyzer cools.
4. Turn off the pump switch.
5. Turn off the optional internal sample pump by setting the analyzer to standby.
6. Back-flush the heated sample line (and filter) of any sample before disconnecting and powering down.

10. Functional Description

10.1. Operating Principle

The California Analytical Model 600 CLD Analyzer utilize the chemiluminescent method of determination of oxides of nitrogen (NO or NO_x) in a sample gas. In the NO mode, the NO in the sample is quantitatively converted to NO₂ by gas phase oxidation with molecular ozone produced by the UV reaction of cylinder air. Generally, 10 to 15 percent of these NO₂ molecules are elevated to an electronically-excited state. This reaction is immediately followed by reversion to a non-excited state and emission of photons. The photons impinge on a photodiode detector (PHOTODIODE) which generates a low DC current directly proportional to the NO contained in the sample gas. This current is amplified by a precision electrometer and presented to digital panel meter and recorder output. In the NO_x mode, the sample is first routed to the NO_x converter where the NO₂ component is reduced to NO. The complete sample is analyzed by the PHOTODIODE as above. The instrument contains heated sections which keep the sample at approximately 100 degrees C prior to the reaction chamber. All temperatures are measured by N.I.S.T. traceable standards.

10.2. Reaction Chamber

The sample and ozone are delivered to the reaction chamber via the unique regulated flow system described below. The sample and ozone are mixed together at the center of the chamber where the reaction takes place. The sample is vented from the chamber through a 1/8 inch stainless steel tube. The chamber contains a red filter which is sealed with an integral O Ring. The chamber assembly is O Ring mounted to the PHOTODIODE. The complete chamber and PHOTODIODE assembly is housed in an RFI shielded enclosure.

10.3. Flow System

The basic function is to deliver highly regulated flows of sample and air or O₂ to the ozonator and reaction chamber assemblies. An EPC valve delivers air at approximately 15 PSIG to a pre-set capillary and consequently accurately predetermines the ozone flow rate. The air supply cylinder should be set to 25 psig. The sample is presented to the reaction chamber via a precision, factory set electronically controlled proportional pressure valve through a capillary. This pressure is factory set at approximately 3.85 PSIG. A close coupled by-pass capillary minimizes "dead volume" and improves response time. Sample inlet pressure and regulated air pressures are monitored by internal pressure transducers and presented in PSIG via the diagnostics screen. NOTE: The correct pressures are determined by the factory for optimum analyzer performance and measured by N.I.S.T. traceable standards. They are recorded on the Factory Settings Screen.

Section 10
DESCRIPTION

FUNCTION

10.4. Main Electronics Board

The main electronics board contains the instrument power supplies and required instrument electronics. A single transformer provides power to the main circuit board and includes provisions for 110/220 VAC at 50/60 Hz input.

10.5. Relay Board

The relay circuit board contains the logic circuitry required to control and switch the AC power to the required heaters and sample pump.

11. Reaction Chamber

11.1. Disassembly Procedure

- a. Shut off ALL gas flow.
- b. Remove power from the instrument.
- c. Remove the top cover retaining screws.
- d. Remove all 4 tubes from the 4 way cross.
- e. Remove the 4 screws securing the photodiode and reaction chamber from the oven.
- f. Remove the photodiode electrical connector from the main circuit board.
- g. Remove the chiller connection from the photodiode/reaction chamber.
- h. Separate the photodiode and heat sink assembly from the reaction chamber by removing the 4 Allen screws from the front of the heat sink. Save the 2 black rubber "O" rings.
- i. Separate the mounting plate and the glass filter from the reaction chamber. Save the 2 Teflon spacers and "O" ring.
- j. Separate the manifold from the gold reaction chamber. NOTE the position of the holes in the Teflon gasket relative to the assembly screw holes. The large hole is ozone.

11.2. Assembly Procedure

- a. Wash the reaction chamber glass filter and manifold separately in detergent using a test tube brush. Be careful of the sample tube in the manifold. Do not use abrasives.
- b. Dry by blowing clean with dry nitrogen.
- c. Reassemble the chamber assembly in reverse order per the above. Make certain the sample tube is centered when assembling the manifold to the reaction chamber.

Section 12

TROUBLESHOOTING

12. Troubleshooting

12.1. Ozone Air/O2 Supply

The Air/O2 flow is controlled by an EPC valve. It requires 25 psig cylinder supply pressure and is factory set to deliver approximately 10 to 20 psig to the ozone capillary. This pressure may be monitored by the diagnostics meter. The flow rate from the capillary is very low and will require a bubble flow meter to accurately determine proper flow.

12.2. Sample Supply

The sample flow is controlled by an adjustable electronic proportional pressure valve. This valve requires a 10 to 25 PSIG sample supply pressure to deliver the proper pressure to the sample capillary. This pressure may be monitored by the diagnostics meter at any time after inlet sample has been applied. The sample flow rate from the capillary is very low and will require a bubble flow meter to determine proper flow rate. If the pressure is properly set, and a clogged capillary is suspected, replace the sample capillary.

NOTE: If the analyzer contains an optional internal sample pump, the introduction of a pressurized sample gas in excess of 1.5 PSIG will damage the pump.

12.3. NO/NOx Converter

Several published test procedures require periodic NOx efficiency tests to be performed on the converter to determine NO2 to NO conversion efficiency utilizing a NOx generator. The CAI Model NOxGen may be used for this procedure. A short test using NO2 calibration gas is also defined in the U.S Federal Register, Title 40, Part 86.332.79 (e).

13. Drawings

13.1. AK Protocol

13.2. Rear Panel Connections

13.3. Flow Diagrams

13.4. Block Electrical Drawing

13.1 Serial Interface and AK-Commands

The serial interface enables remote control of the Model 600 analyzer by a master computer. It is implemented as an RS232 V24 interface and meets all requirements of the AK protocol. A 9-pin male connector at the back of the unit is used to connect a master computer with the following pin assignment:

Pin 3 = Txd (transmit)
Pin 2 = Rxd (receive)
Pin 5 = Gnd (ground)

Interface Parameters

Baud rate: 9600, 4800, 2400, 1200, 600, 300 baud
Data bits: 7 or 8
Stop bit: 1 or 2
Don't care: 1 byte, adjustable (e.g. 32)
Parity: Even, odd, none
XON/XOFF: Active or not active

General AK Requirements

- 1) If the command message contains no error, the acknowledge message contains the echo of the function code and the error status number (1 to 9).
- 2) If the transfer was faulty or the function code unknown, the answer contains four question marks (example. "???? 0").
- 3) If the displayed value is not valid, a "#" is placed in front of the measured value (example: "AIKG 0 #9999").
- 4) If a control or adjusting command is sent via the serial interface while the measuring device is in "Manual" mode, it sends an answer like "SLIN 0 KO OF".
- 5) If a channel does not exist, the answer for control and adjusting commands is e.g. "ATEM 0 3 NA" in which 3 is the number of the sub-channel.
- 6) If the device is busy with a running function (SLIN, for example), every arriving control command is ignored (except SRES and STBY); and the response message is e.g. "SMAN 0 BS. If in the mode "SINT" an additional "SINT KO" command is received, the integrator is reset to 0 and the integration is restarted.
- 7) If the command message contains data that the measuring device cannot process ("ESYZ K0 ABC", for example), the response message is "ESYZ 0 SE". A syntax error is recognized if the data does not match the expected format or if the parameters do not fit the expected size.
- 8) Numbers are in floating-point format with decimal point. The decimal point can be dropped for integers.
- 9) If you switch from "Manual" to "Remote" at the device, it remains in "Manual" mode until a "SREM K0" is received by the control computer. On the display, this mode is indicated by REME" (Remote enable) on the status line. In manual mode, query commands via the serial interface are possible at any time.

AK Protocol Format

The master computer and the Model 600 analyzer communicates via the RS232 serial link. The Model 600 analyzer acts as a "slave" and only responds to commands.

Serial Interface Parameters:

- 1) Baud from 300 to 9600 bps, can be selected via the display.
- 2) 7 or 8 data bits, 1 or 2 stop bits, and the parity (yes/no).
- 3) The data transmission is full duplex (no echo) with XON/XOFF protocol.
- 4) The "don't-care" byte" (byte 2) is adjustable (factory setting 20H).

Command Format:

<STX> 02H Example: ASTZ K0
 don't care any byte (default 20H)
 function code code 4 byte long (e.g., ASTZ)
 space 20H 20H
 channel N° always "K0" for the analyzer
 space 20H (only if followed by data, otherwise <ETX>)
 data data bytes (depending on the command)
 <ETX> 03H

Answer Format:

<STX> 02H Example: STZ 0 SREM STBY
 don't care adjustable, factory setting 20H
 function code same code as command package (e.g., ASTZ)
 space 20H
 status 0 without error or 1 to 9 when error (see also ASTF command)
 space 20H (only if followed by data, otherwise <ETX>)
 data parameter (depending on the command)
 <ETX> 03H

Scans

AKON: Measured concentration value

Command	Response	Description
_AKON_K0	_AKON_s_z.z_y_x.x_w.w	Measured concentration value is responded z.z:current Measured Value y.y:NO x.x: NO2 w.w:Nox y.y,x.x,w.w are only used in dual measure mode. Otherwise "O.O" will be returned

AEMB: Set measuring range

Command	Response	Description
_AEMB_K0	_AEMB_s_Mn	Current measuring range is responded

AMBE: Measuring range limit

Command	Response	Description
_AMBE_K0	_AMBE_s_M1_w.w_M2_x.x_M3_y.y_M4_z.z	All existing measuring range limits are responded
_AMBE_K0_Mn	_AMBE_s_Mn_z.z	Range limit of Range Mn is responded

AKAK: Calibration gas concentrations

Command	Response	Description
AKAK_K0	_AKAK_s_M1_w.w_M2_x.x_M3_y.y_M4_z.z	All existing calibration gas values are responded
AKAK_K0_Mn	AKAK_s_Mn_z.z	Calibration gas value of Range Mn is responded

AMBU: Upper and lower range switchover values for autorange

Command	Response	Description
_AMBU_K0	_AMBU_s_M1_w.w_W.W_M2_x.x_X.X_M3_y.y_Y.Y_M4_z.z_Z.Z	Lower and upper range switchover value of autorange are responded

ASTZ: Normal device status

Command	Response	Description
_ASTZ_K0	_ASTZ_s_SREM_STBY__SENO_SARE_SDRY	Device status is responded

Possible states:

SREM: remote	STBY: standby	SENO: NO mode	SARE: Autorange on	SDRY: Chiller on
SMAN: manual	SPAU: pause	SMAN: NOx mode	SARA: Autorange off	SWET: Chiller off
	SMGA: measuring gas			
	SNGA: zero gas			
	SEGA: end gas			
	SATK SNGA: zero gas during autocal			
	SATK SEGA: end gas during autocal			
	SLIN: For compatibility only			
	SSPL: purging			
	SKOP: measure			

ASTF: Error status

Command	Response	Description
---------	----------	-------------

_ASTF_K0

_ASTF_s_f1_f2_f3...f15

Current error number is responded

Errors:

1	Sample Pressure Failure
2	Air Pressure Failure
3	Oven Temp Failure
4	Converter Temp Failure
5	Pump Temp Failure
6	Diode Temp Failure
7	Cell Temp Failure
8	Peltier Gas Temp Failure
9	Reaction Chamber Temp Failure
10	EPC Coil Sample Failure
11	EPC Coil Air Failure
12	Range Overflow
13	ADC Range Overflow
14	ADC Range Underflow
15	Range 1 is not calibrated
16	Range 2 is not calibrated
17	Range 3 is not calibrated
18	Range 4 is not calibrated

AKEN: Device identification

Command	Response	Description
_AKEN_K0	_AKEN_s_devicename	Device identification is responded
_AKEN_K1	_AKEN_s_model	Device model
_AKEN_K2	_AKEN_s_serialno	Device serial number
_AKEN_K3	_AKEN_s_airpressure	Suggested input air pressure
_AKEN_K4	_AKEN_s_samplepressure	Suggested input sample pressure

ARMU: Rawvalue

Command	Response	Description
_ARMU_K0	_ARMU_s_z.z	Raw value before linearization and offset-span-correction is responded

ATEM: Temperatures

Command	Response	Description
_ATEM_K0	_ATEM_s_z.z.y.y...	All Temperatures in degrees celsius are responded
_ATEM_K0_x	_ATEM_s_z.z	Temperature of x in degrees celsius is responded

Description of x:

X	CLD
1	Oven Temp
2	Converter Temp
3	Pump Temp
4	Diode Temp

5	Cell Temp
6	Peltier Temp
7	Reaction Chamber Temp

ADRU: Pressures

Command	Response	Description
_ADRU_K0	_ADRU_s_z.z_y.y_...	All pressures are responded
_ADRU_K0_x	_ADRU_s_z.z	Pressure of x is responded

Description of x:

1	Sample Pressure
2	Air Pressure
3	Sample EPC Coil Voltage
4	Air/Ozone EPC Coil Voltage

ADUF: Flows

Command	Response	Description
_ADUF_K0	_ADRU_s_z.z_y.y_...	All flows are responded
_ADUF_K0_x	_ADRU_s_z.z	Flow of x is responded

Description of x:

1	Sample Flow
2	Air Flow

AGRD: Polynom coefficients

Command	Response	Description
_AGRD_K0_Mn	_AGRD_s_Mn_a0_a1_a2_a3_a4	Polynom coefficients of range Mn are responded

AANG: Deviation from zero point after autocalibration

Command	Response	Description
_AANG_K0	_AANG_s_M1_z.z_da_dr_ M2_z.z_da_dr_ M3_z.z_da_dr_ M4_z.z_da_dr_	Deviation from zero point after autocalibration

AAEG: Deviation from end point after autocalibration

Command	Response	Description
_AAEG_K0	_AANG_s_M1_z.z_da_dr_ M2_z.z_da_dr_ M3_z.z_da_dr_ M4_z.z_da_dr_	Deviation from end point after autocalibration

AFDA: Purge and Autocalibration times

Command	Response	Description
_AFDA_K0_SATK	_AFDA_s_z_y_x_w_Z.Z	Autocalibration times: z: Purge time y: Calibration time x: Total Calibration time w: Verify time (z,y,x,w in seconds)
_AFDAKO_SSPL	AFDA_s_z.z	Purge time will be responded

APAR: Request Autocalibration tolerance values

Command	Response	Description
_APAR_K0_SATK	_APAR_s_z.z_y.y_x.x_w.w	Autocalibration tolerance value(%): z.z: Range 1 y.y: Range 2 x.x: Range 3 w.w: Range 4

AKAL: Deviations from calibration

Command	Response	Description
_AKAL_K0_	_AKAL_s_M1_z.z_y.y_x.x_w.w _AKAL_s_M2_z.z_y.y_x.x_w.w _AKAL_s_M3_z.z_y.y_x.x_w.w _AKAL_s_M4_z.z_y.y_x.x_w.w	Deviation (ppm): z.z: Zero gas relative to last calibration y.y: Zero gas factory calibration x.x: Span gas relative to last calibration w.w: Span gas factory calibration

ASYZ: Respond System Time

Command	Response	Description
_ASYZ_K0_	_ASYZ_s_yymmdd_hhmmss	Respond system time yymmdd:year, month,day (each 2 characters wide, no spaces) hhmmss:hour,minutes,seconds)

AT90: Respond Lowpass filter time

Command	Response	Description
_AT90_K0_	_AT90_s_t	Respond lowpass filter time t=filter time in seconds

ADAL:Diagnostic alarm limits

Command	Response	Description
_ADAL_K0	_ADAL_s_a1.min_a1.max_.._f12.max	All alarms are responded
_ADAL_K0_x	_ADAL_s_x.min_x.max	Alarm limits of x

Alarm Limits:

1	Sample Pressure
---	-----------------

2	Air Pressure
3	Oven Temp
4	Converter Temp
5	Pump Temp
6	Diode Temp
7	Cell Temp
8	Peltier Gas Temp
9	EPC Coil Sample Voltage
10	EPC Coil Air/Ozone Voltage
11	Reserved
12	Sample Content

ATCP: Query TCP/IP settings

Command	Response	Description
_ATCP_K0	_ATCP_s_zzz.zzz.zzz.zzz _ATCP_s_yyy.yyy.yyy.yyy _ATCP_s_xxxx	zzz: TCP/IP Address yyy: TCP/IP subnet mask xxxx: TCP/IP port

AENT: Query calibration gas flow setting

Command	Response	Description
_AENT_K0	_AENT_s_x	x=10: Calibration through sample gas inlet (pump) y=11: Calibration through zero/span valves

Control commands**SRES:** Reset

Command	Response	Description
_SRES_K0	_SRES_s	Reset

SPAU: Pause

Command	Response	Description
_SPAU_K0	_SPAU_s	Pause mode

STBY: Standby

Command	Response	Description
_STBY_K0	_STBY_s	Standby mode

SNGA: Open valve for zero gas calibration

Command	Response	Description
_SNGA_K0	_SNGA_s	Open valve for zero gas calibration of actual measuring range
_SNGA_K0_Mn	_SNGA_s	Open valve for zero gas calibration of range Mn

SEGA: Open valve for end gas calibration

Command	Response	Description
_SEGA_K0	_SEGA_s	Open valve for end gas calibration of actual measuring range
_SEGA_K0_Mn	_SEGA_s	Open valve for end gas calibration of range Mn

SSPL: Purge Analyzer with zero gas

Command	Response	Description
_SSPL_K0	_SSPL_s	Open valve for zero gas and purge the analyzer

SLIN: Linearization mode

Command	Response	Description
_SLIN_K0	_SLIN_s	Change status to SLIN (only for compatibility)

SKOP: Converter Check

Command	Response	Description
_SKOP_K0	_SKOP_s	Change status to SKOP and activate sample pump (only for compatibility)

SWET: Chiller off – Wet mode measuring

Command	Response	Description
_SWET_K0	_SWET_s	Switch chiller off

SDRY: Chiller on – Dry mode measuring

Command	Response	Description
_SDRY_K0	_SDRY_s	Switch chiller on

SATK: Start automatic calibration

Command	Response	Description
_SATK_K0	_SATK_	Start automatic calibration of all ranges
_SATK_K0_Mn	_SATK_s	Start automatic calibration using range Mn

SEMB: Set measuring range

Command	Response	Description
_SEMB_K0_Mn	_SEMB_s	Set measuring range Autorange is disabled

SARE: Auto range on

Command	Response	Description
---------	----------	-------------

_SARE_K0	SARE_s	Set auto range on
----------	--------	-------------------

SARA: Auto range off

Command	Response	Description
_SARA_K0	_SARA_s	Set autorange off

SREM: Remote mode for AK-commands

Command	Response	Description
_SREM_K0	_SREM_s	Set device in remote mode

SMAN: Manual control to control device manually

Command	Response	Description
_SMAN_K0	_SMAN_s	Set device in manual mode

SMGA: Start measuring

Command	Response	Description
_SMGA_K0	_SMGA_s	Start measuring Turn on pump for sample gas

SNKA: Saves measured value as new offset.

Command	Response	Description
_SNKA_K0	_SNKA_s	Saves measured value of actual range as new offset if zero valve is opened

SEKA: Saves measured value as new span value

Command	Response	Description
_SEKA_K0	_SEKA_s	Saves measured value of actual range as new span value if span valve is opened

SENO: Converter off

Command	Response	Description
_SENO_K0	_SENO_s	Set converter off Only NO is measured

SNOX: Converter on

Command	Response	Description
_SNOX_K0	_SNOX_s	Set converter on All kinds of NOx are measured

SNO2: Converter on

Command	Response	Description
_SNO2_K0	_SNO2_s	Activates dual measure mode. Analyzer switches periodically between

Command	Response	Description
SFGR: Reset calibration settings to factory default		
Converter on		
_SFGR_K0	_SFGR_s	Reset all calibration settings to their factory settings
SENT: Set calibration gas flow		
Converter on		
_SENT_K0_x	_SENT_s	x=10: Calibration through sample gas inlet (pump) y=11: Calibration through zero/span valves

Settings

EKAK: The four span gas concentration values are set

Command	Response	Description
_EKAK_K0_M1_w.w_M2_x.x_M3_y.y_M4_z.z	_EKAK_s	Set end gas values

EMBE: The four measuring range end values are set

Command	Response	Description
_EMBE_K0_M1_w.w_M2_x.x_M3_y.y_M4_z.z	_EMBE_s	Set range limits

EMBU: The upper and the lower range switchover for autorange are set

Command	Response	Description
_EMBU_K0_M1_w.w_W.W_M2_x.x_X.X_M3_y.y_Y.Y_M4_z.z_Z.Z	_EMBU_s	Set lower and upper range switchover limits

EKEN: Set new device identification

Command	Response	Description
_EKEN_K0_new device-name	_EKEN_s	Set new device identification Maximum length of device name are 40 characters

NOTE: To change device identification, you must first rename the device to "RESET".
Now a name up to 40 letters can be given.

NOTE: The device name must not have any blanks between, f.e. "CAI CLD" is not allowed. You can use underline, i.e. "CAI_CLD".

EGRD: Set polynom coefficients

Command	Response	Description
_EGRD_K0_Mn_a0_a1_a2_a3_a4	_EGRD_s	Set polynom coefficients of range Mn

EFDA: Set autocalibration and purge times

Command	Response	Description
_EFDA_K0_SATK_z_y_x_w	_EFDA_s	Set autocalibration times: z= Purge time y=Calibration time x=Total calibration time w=Verify time (z,y,x,w in seconds)
_EFDA_K0_SSPL_z	_EFDA_s	Set analyzer purge time to z seconds

EPAR: Set autocalibration tolerance values

Command	Response	Description
_EPAR_K0_SATK_z.z_y.y_x.x_w. w	_EPAR_s	Autocalibration Tolerance value (%): z.z= Range 1 y.y= Range 2 x.x= Range 3 w.w= Range 4

ESYZ: Set System Time

Command	Response	Description
_ESYZ_K0_yymmdd_hhmmss	_ESYA_s	Respond system time: yymmdd:year, month,day (each 2 characters wide, no spaces) hhmmss:hour,minutes,seconds)

ET90: Set Lowpass Filter Time

Command	Response	Description
_ET90_K0_t	_ET90_s	Set lowpass filter time: t= filter time in seconds

EDAL:Diagnostic alarm limits

Command	Response	Description
_EDAL_K0_a1.min_a1.mas_..._a12max	_EDAL_s	Set all alarm limits
_EDAL_K0_x_x.min_xmax	_EDAL_s	Set alarm limits of x

Alarm Limits:

1	Sample Pressure
2	Air Pressure
3	Oven Temp
4	Converter Temp
5	Pump Temp
6	Diode Temp
7	Cell Temp
8	Peltier Gas Temp
9	EPC Coil Sample Voltage
10	EPC Coil Air/Ozone Voltage
11	Reserved

12	Sample Content
----	----------------

ETCP: Set TCP/IP Parameters

Command	Response	Description
_ETCP_K0_zzz.zzz.zzz.zzz	_ETCP_s	zzz= TCP/IP address
_ETCP_K0__yyy.yyy.yyy.yyy		yyy= TCP/IP subnet mask
_ETCP_K0_xxxx		xxxx= TCP/IP port
		All changes take effect after next power on cycle

Abbreviations used

Mn	: Measuring range number
M1 .. M4	: Measuring Range 1 .. 4
w.w .. Z.Z.	: Numerical value
x	: Number
t	: Numeric integer value
a0 .. a4	: Polynom coefficients
s	: Status
yyymmdd	: Date of format year, month and day with 2 characters each and no spaces
hhmmss	: Time of format hour, minute and second with 2 characters each and no spaces

13.2 Rear Panel Connectors

28 Pin Main Connector Assignments:

28 Pin Auxiliary Connector Assignments:

Signal Type	Analog	Signal Type	Analog
	pin #	Spare	pin #
A Output	1 GND (analog) Realtime 0-10 VDC	A Input	1 GND (analog)
A Output	2 Maximum	A Input	2 External Analog 1
A Output	3 NO 0-10 VDC Maximum NOx 0-10 VDC	A Input	3 External Analog 2
A Output	4 Maximum NO2 0-10 VDC	A Input	4 Spare analog
A Output	5 Maximum	A Input	5 Spare analog
	Digital	Alarms	Digital
D Output	6 GND (Digital)	D Output	6 GND (Alarm)
D Output	7 Sense AutoRange	D Output	7 General Alarm
D Output	8 Sense Range 1	D Output	8 Ch. 1 Conc. 1 Alarm
D Output	9 Sense Range 2	D Output	9 Ch. 1 Conc. 2 Alarm
D Output	10 Sense Range 3	D Output	10 Reserved
D Output	11 Sense Range 4	D Output	11 Reserved
D Input	12 Set AutoRange	D Output	12 Reserved
D Input	13 Control Range 1	D Output	13 Reserved
D Input	14 Control Range 2	D Output	14 Reserved
D Input	15 Control Range 3	D Output	15 GND (Alarm)
D Input	16 Control Range 4	D Output	16 Calibration Alarm 1
D Input	17 Auto Cal	D Output	17 Reserved
D Input	18 Calibrate	D Output	18 Reserved
D Input	19 Zero	D Output	19 Reserved
D Input	20 Span	D Output	20 Read Wet Mode
D Input	21 Pump	D Output	21 Read OverFlow
D Output	23 Span Gas Flow	D Input	23 Set Wet Mode
D Output	24 Sample Gas Flow	D Input	24 Set OverFlow
D Output	25 Local/Remote	D Input	25 Set NO Mode
D Output	26 Read Cal Mode	DI/DO	26 Spare
D Output	27 Reserved	DI/DO	27 Spare
D Output	28 Reserved	DI/DO	28 Spare



Note: All digital outputs and inputs are 0-5 VDC ONLY. All analog inputs are 0-10 VDC ONLY. Connecting analog outputs to existing current loop systems or voltage loop systems **WILL DAMAGE** the instrument.

MODEL 600 HCLD Flow Diagrams

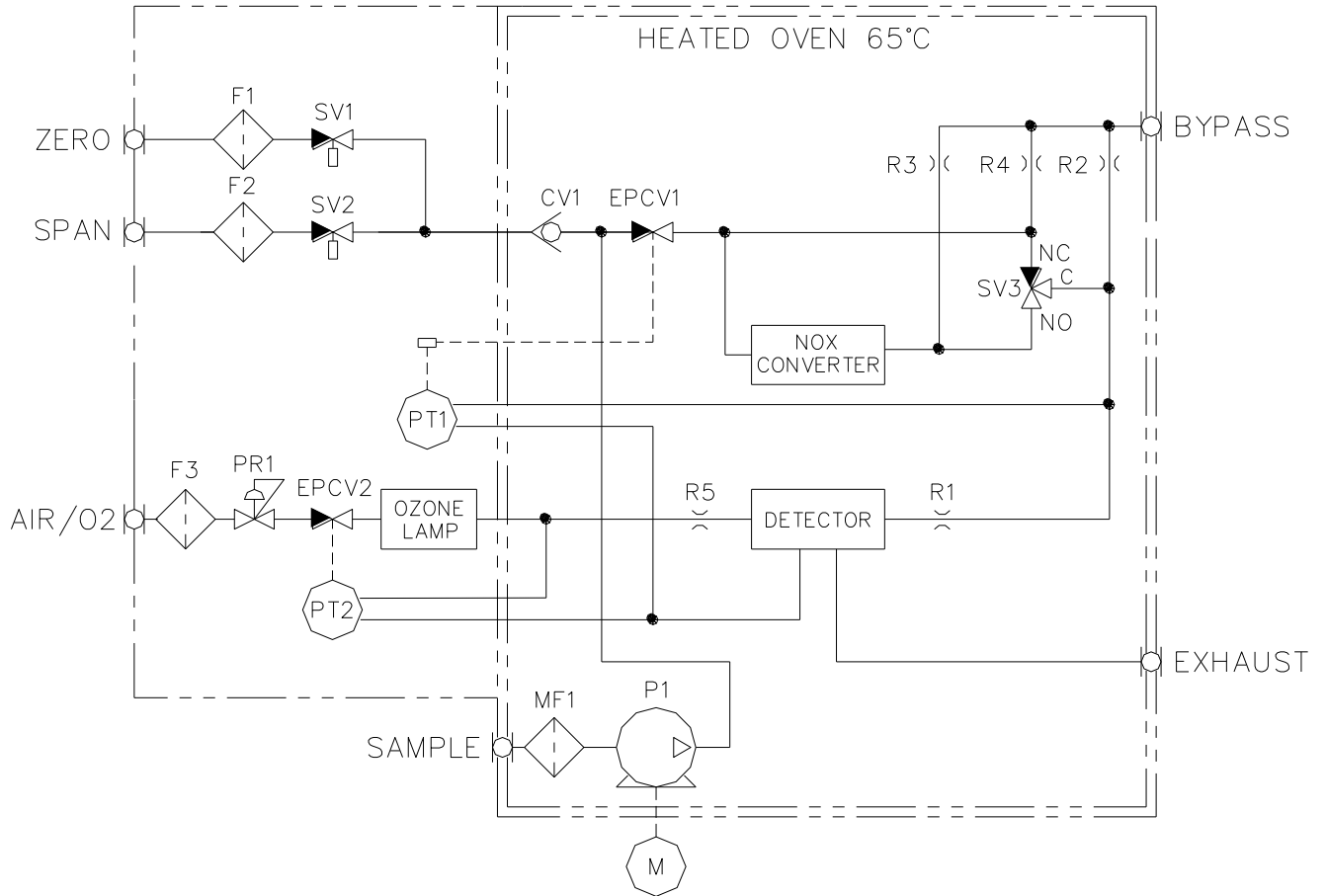

NOTE: Standard Analyzer With Internal Heated Sample Pump

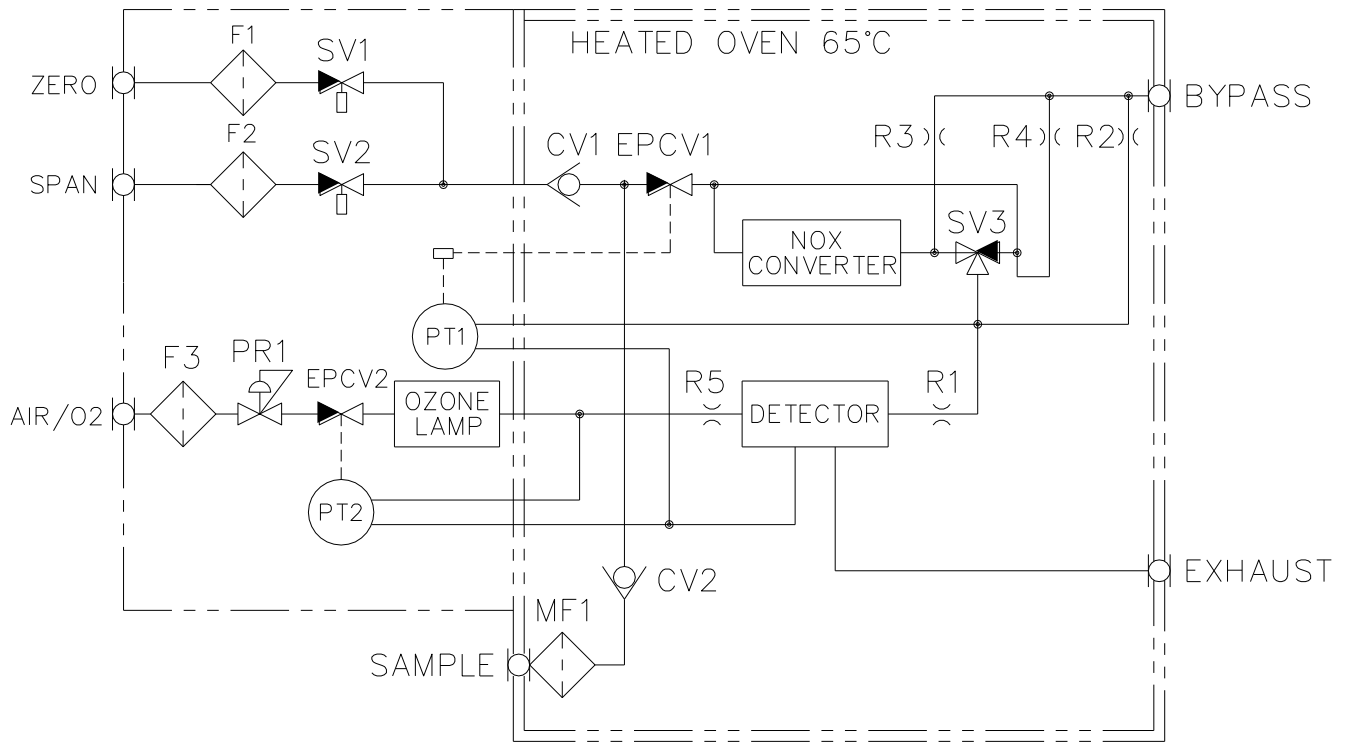

NOTE: Standard Analyzer Without Internal Heated Sample Pump

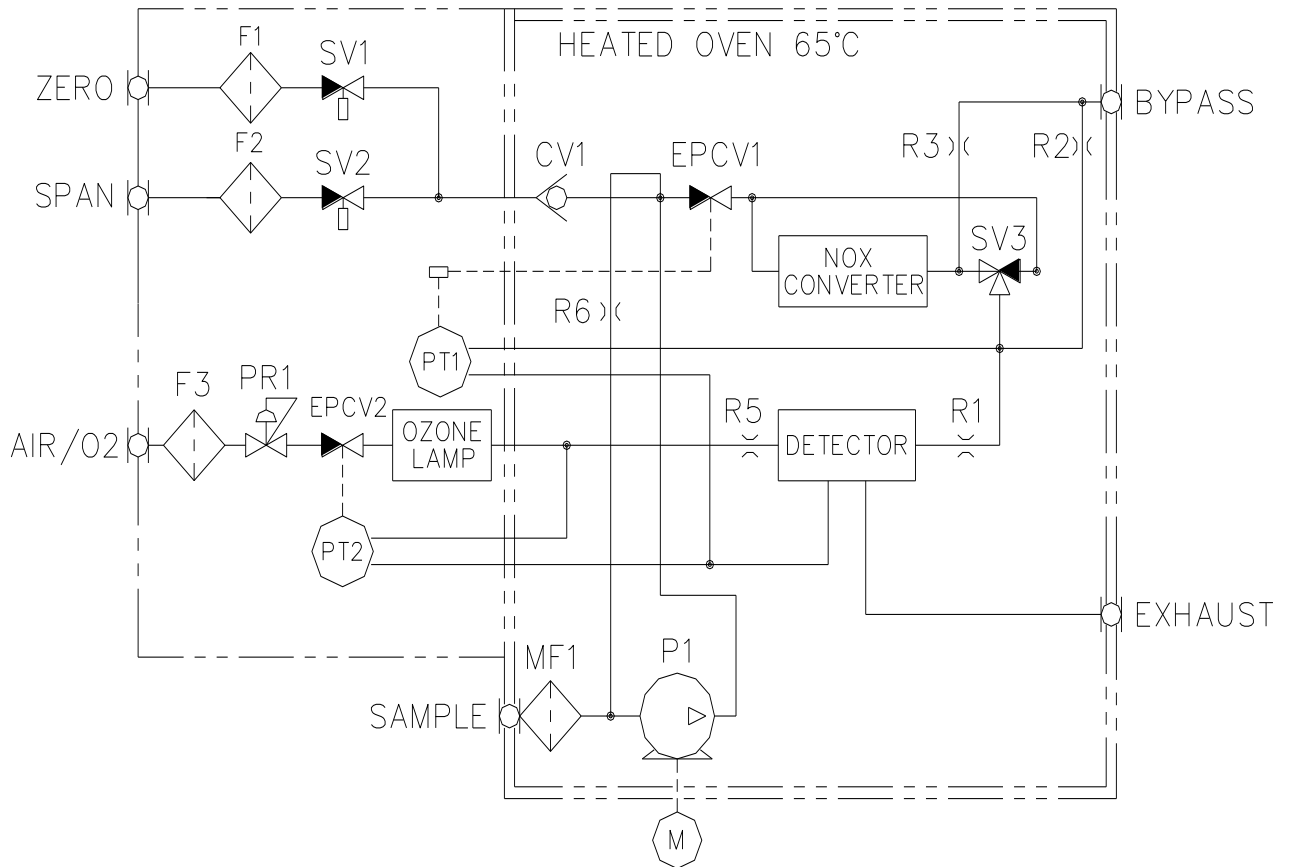

NOTE: Standard Analyzer With LOW FLOW OPTION

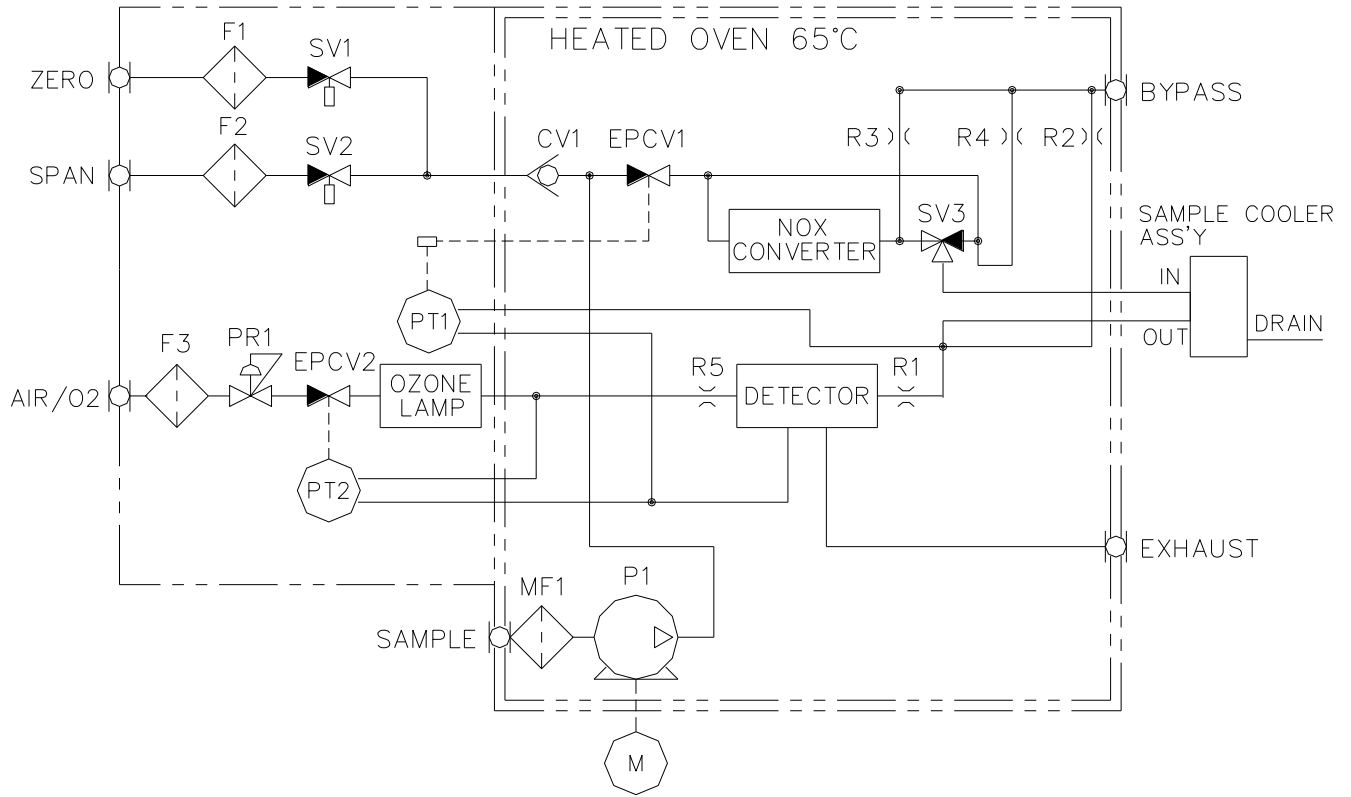

NOTE: Standard Analyzer With Internal Heated Sample Pump and Rear Mounted Chiller

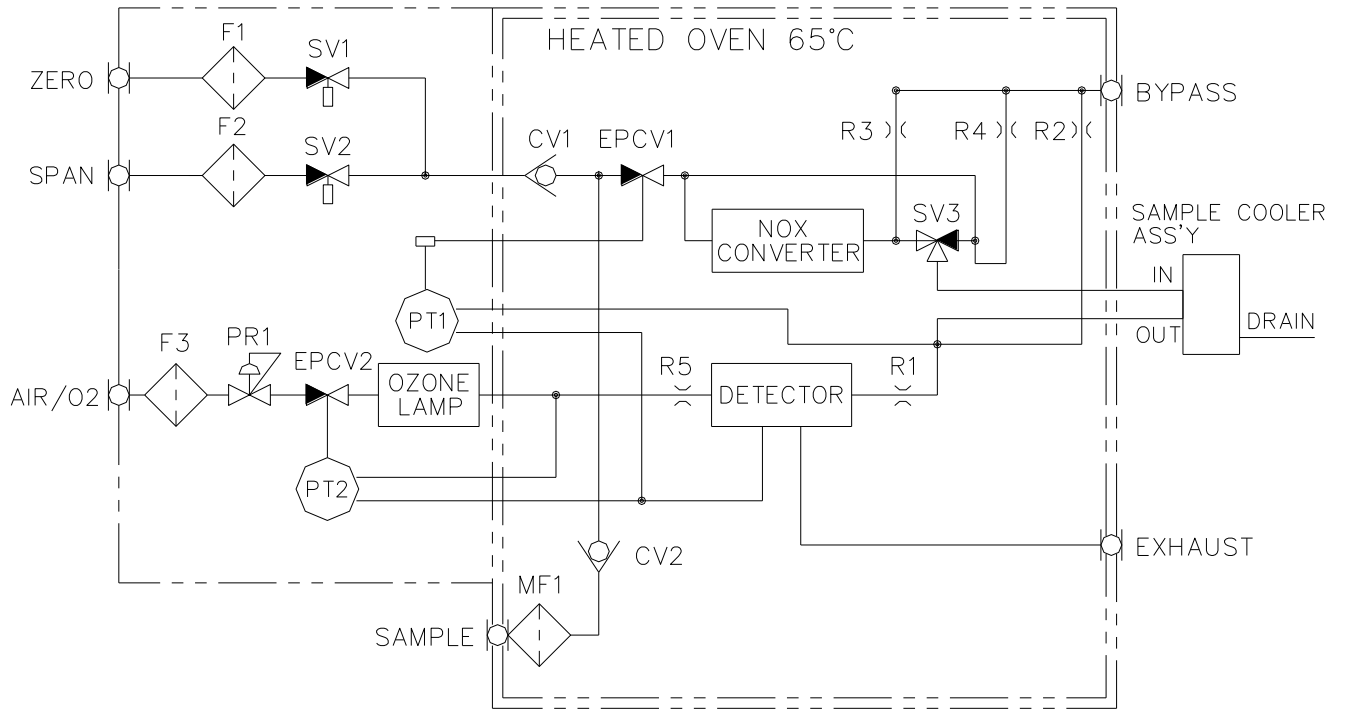

NOTE: Standard Analyzer Without Internal Heated Sample Pump and Rear Mounted Chiller

TABLE OF CONTENTS

ADDENDUM

STARTING AFTER JUNE, 2007

<u>Section</u>	<u>Title</u>	<u>Page</u>
1.0.	Introduction -----	
2.0.	Operation of Measurement Keys -----	
	2.1. Over Range-----	
	2.2. Diagnostics-----	
	2.3. Zero-----	
	2.4. Span-----	
	2.5. Range Limits-----	
	2.6. Span Values-----	
	2.7. Outputs-----	
3.0	New Functions -----	
	3.1. Auto Start Up-----	
	3.2. Alarms On/Off-----	
	3.3. Offset & Gain-----	
	3.4. Calibrate The Analog Outputs-----	
	3.5. Save Data Archiving Time-----	
	TABLE A-----	
	3.6. User Digital Outputs-----	
	TABLE B-----	
	TABLE C-----	
	3.7. Cal Analog Output-----	
4.0.	Changes To Existing Functions -----	
	4.1. Saved or Outside Limits-----	
	4.2. Calibration Deviations-----	
	4.3. Flow Zero or Span Gas-----	
	4.4. Reset Calibration Values-----	
	TABLE D-----	

13.5 Starting With SERIAL NUMBER U06081

1.0 INTRODUCTION

The Model 600 CLD Series Instruments starting with Serial Number U06081 have several new Hardware and Software features.

The Hardware includes the use of a new memory system, isolation of the analog output signals and 15 relays that are used to buffer the many new digital output signals that are now available. **SEE TABLE D**

The available digital signals consist of a SERVICE group, to externally monitor a number of parameters that provide insight for preventative maintenance and diagnostics decisions.

A second STATUS group, is provided to define the operation of the instrument such as Spanning, Zeroing, Calibrating and the Current Range (1, 2, 3, 4, AUTO).

The Software includes modifications to existing functions, changes to the Measurement screen, additional Short-Cut Keys and several New Functions that are listed as follows:

- **MEASUREMENT**

Over Range	888888
Zero	F5
Span	F6
Range Limits	F8
Span Values	F9
Outputs	F10

Note: The operator can use these Short-Cut Keys or continue to use existing procedures.

- **NEW FUNCTIONS**

Auto Startup	F5, F7, F7
ALARMS	F5, F7, (Use F6 to toggle ON/OFF)
Offsets& Gains	F4, F3, F5
D/A Calibration	F5, F7, F8
Cal Analog Outputs	F5, F8, (Use F8 to toggle ON/OFF)
Save Data Archiving Time	F5, F7, F1, F5 (Use ENTER to change record time)
User Digital Outputs	F5, F9

- **MODIFICATIONS**

Saved/Not good	F4, F2, F1 or F2 (To flow Zero or Span Gas)
-----------------------	----------------------------------------------------

2.0 OPERATION OF MEASUREMENT KEYS

Note: The ← & → Keys continue to be used to view a complete list of menu items.

2.1 Over Range 888888

In the MEASUREMENT mode only, any value that exceeds the “range” by more than 10% will be displayed as 888888.

2.2 Diagnostics: Use **F3** to toggle between MEASUREMENT and DIAGNOSTIC.

2.3 Zero: From the MEASUREMENT Screen select the required range for calibration then press **F5**.

Note: For instruments with an internal Zero Solenoid select Calibration by Valves. (**Main, F5, F2, F4**)

Manual Zero 4: SEND	Manual Zero 3: SMAN
Zero gas. Use F3 To Toggle Diagnostics. Cal Via	Zero gas. Use F3 To Toggle Diagnostics Cal Via *Using Current Temp & Press*
-375.00 NO	0.08 NOx
Range4: 3000ppm	Range1: 100.0ppm
F1 Save value NO: -375.0 F2 Man. Cal. Menu O2: 0.1 %	F1 Save value NOx: 0.1 F2 Man. Cal. Menu O2: 0.0 %
Check Air EPC Coil V	Thu May 15 06:15:11 2008

2 versions

Zero Gas will be enabled and the observed results can be used to evaluate instrument performance.

Press **F3** to toggle to the Diagnostic screen for additional information

Press **F1** to save the value and complete a ZERO calibration for this channel and range

Press **MAIN, F1** to return to the MEASUREMENT screen to select other channels and ranges and repeat the process. Or press **F2** to return to the Manual Calibration Screen

2.4 Span: From the MEASUREMENT Screen select the required range then press **F6**.

Note: For instruments with an Internal Span Solenoid select Calibration by Valves. (**Main, F5, F2, F4**)

Manual Span		5: SWET			
Span gas. Use F3 to Toggle Diagnostics. Cal Via					
- 375.00					
NO		Conc.: 1860.00000			
Range4: 3000ppm					
F1 Save value			NO: -375.0		
F2 Man. Cal. Menu			O2: 0.1 %		

Manual Span		5: SWET			
Span gas. Use F3 To Toggle Diagnostics Cal Via *Using Current Temp & Press*					
0.00					
NOx		Conc.: 90.00000			
Range1: 100.0ppm					
F1 Save value			NOx: 0.0		
F2 Man. Cal. Menu			O2: 0.0 %		
CAI Tel. (800) 959 0959					

2 versions

Span Gas will be enabled and the observed results can be used to evaluate instrument performance.

Press **F3** to toggle to the Diagnostic screen for additional information

Press **F1** to save the new value and complete the SPAN calibration for this Range.

Note: The span gas value used for this range is highlighted and can be changed if necessary. Use the Enter key and the numeric keys as required

Press **MAIN, F1** to return to the MEASUREMENT screen to select other ranges and repeat the process or press **F2** to return to the Manual Calibration screen

2.5 Range Limits: F8 From the MEASUREMENT Screen;

Setup		5: SWET	⏏
Upper range limits [ppm]			
*** MUST be ASCENDING ***			
RRR	Range 1:	3.00	
	Range 2:	30.00	
	Range 3:	300.00	
	Range 4:	3000.00	
Do NOT Exceed Max Range			
		N0: -375.0	
		O2: 0.1 %	
Wed Jan 03 23:24:23 2001			

Setup		1: SARA	⏏
Upper range limits [ppm]			
*** MUST be ASCENDING ***			
	Range1:	100.00	
	Range2:	500.00	
	Range3:	1000.00	
	Range4:	3000.00	
Maximum Range Limit: 3000.000			
F1 Save with new		N0x: 0.1	
autorange Up/Down		O2: 0.0 %	
CAI Tel. (800) 959 0959			

2 versions

The standard analyzer is factory configured with 4 Physical Ranges of 3, 30, 300, 3,000 PPM.

The optional high level analyzer is factory configured with 4 Physical Ranges of 5, 50, 500, 500

The operator can change the number of ranges and select a more convenient full scale concentration if required.

Note: Do not exceed the maximum range set by the factory and always use ascending order as shown.

Example a) For a single range instrument, set Range 1 to the desired value and all others to zero

b) For a two range instruments, set Range 1 to the lowest value, Range 2 to the highest value and the others to zero. .

2.6 Span Values: F9 From the MEASUREMENT Screen

Setup		1: SARA	⏏
Span gas conc. range limits			
	Range1:	2.250	3.00
	Range2:	18.500	30.00
	Range3:	186.500	300.00
	Range4:	1860.000	3000.00
	O2:	0.000	
		N0: -375.0	
		O2: 0.1 %	
Check Sample EPC Coil U			

Use to define the concentration of the span gas that will be used to calibrate each range.

Note: The span gas value used for this range is highlighted and can be changed if necessary. Use the Enter key and the numeric keys as required.

2.7 Outputs: F10 From the MEASUREMENT Screen

Output	Signal
1	NO
2	NOx
3	NO2
4	RealTime

NOx: 11.3

CAI Tel. (800) 959 0959

Use the \uparrow to select the desired Output. Press Enter to select
Use the \downarrow to select the desired Signal. Press Enter to select

Use this screen to define the signals and their location that will be monitored by a remote reordering device.

Note: NO₂ only active in the "Switching Mode"

SEE TABLE D

3.0 NEW FUNCTIONS

3.1 Auto Start Up: (Main, F5, F7, F7)

Auto Startup		5: SWET	☰
•Auto Startup	:	Off	
•Wait for [min]	:	1	
•Calibrations	:	2	
•Startrange	:	4	
•Access Level	:	2	
•Remote/Manual	:	Manual	
•NO/NOx-Mode	:	NO	
MAIN SAVE		NOx: 22.5	
BACK SAVE			
Check Air Pressure			

All key analyzer parameters are stored in a secure memory location and retained when power is removed

In the event of an unexpected power failure it may be desirable to change some parameters until an operator can resume control.

This screen may be used to establish several desirable special instrument start-up parameters that define how the analyzer recovers from loss of AC power

When enabled this screen will define the following:

Wait: The time delay in minutes before proceeding. If “Zero” is selected the instrument will wait until all temperature warnings are cleared.

Calibrations: The number of attempts to complete a successful calibration as required in the operator defined Deviation Tables. If calibration is not successful the instrument will continue reporting results using the last completed calibration.

The analyzer will utilize the last completed calibration by selecting zero for Calibrations.

Starting Range: When all defined actions are completed the analyzer will return to the Measurement Screen and at the range specified.

Access Level: The user level at Start Up.

Remote/Manual: Put the analyzer in either “Remote” or “Manual” at Start Up

NO/NOx Mode: Put the analyzer in NO or NOx or NO2 mode at Start Up.

3.2 Alarms On/Off: (Main, F5, F7)

All key analyzer parameters are stored in a secure memory location and retained when power is removed. In the event of an unexpected power failure it may be desirable to change some parameters until an operator can resume control.

This screen may be used to establish several desirable special instrument start-up parameters that define how the analyzer recovers from loss of AC power.

When enabled this screen will define the following:

System setup		2: STBY	≡
F1	RealTime-Clock	»	
F2	TCP/IP settings		
F3	Output assignment		
F4	Output Range		
F5	status line on/off		
F6	Alarms on/off	On	
F7	Auto Startup		
F8	D/A calibration		
analyser Alarms		NOx: 43.7	
ON / OFF			
Check Air EPC Coil U			⏏

Use **F6** to toggle ON/OFF

The instrument has an extensive library of warning messages that will aid in the identification of various anomalous events and are displayed at the bottom of the screen. These messages will assist in diagnostics and indicating the need for preventative maintenance

This screen provides an **option** to disable these messages during initial start-up or as may be desired for a particular application.

3.3 Offset & Gain: (Main, F4, F3, F5)

Offset and Gain		
Zero/Span	applied	correction
Range	Offset	Gain
Range1:	0.00	1.00
Range2:	0.00	1.00
Range3:	0.00	1.00
Range4:	0.00	1.00
		N0: -0.8
Thu May 03 12:40:03 2007		

This screen can be used to provide an additional means to display calibration deviations.

The OFFSET is the value stored during zero calibration.

The GAIN is the value stored during span gas calibration using the operator defined calibration gas.

An increasing or decreasing change to the OFFSET or GAIN when used in conjunction with "Deviations" will provide insight to both short and long term changes to system performance

Note: Reset calibration values will reset OFFSETS & GAINS to zero and 1 respectively

3.4 Calibrate the Analog Outputs: (Main, F5, F7, F8) D/A Calibration (Main, F5, F7, F3) Output Assignment

- **Overview**

The 600 CLD Series is designed to provide four analog outputs that can be configured as 0-1 VDC, 0-5 VDC, 0-10 VDC, 4-20 mA, or 0-20 mA.

This screen (**Main, F5, F7, F8**) is used to select the scaling of the current (mA) or voltage (1, 5, 10) range that is required by a remote recording device. The outputs can be calibrated to exactly match the results obtained on a PLC, Recorder, Data Logger or other remote recording device that may be connected to the analyzer.

The operator will first select the **OUTPUT ASSIGNMENT (Main, F5, F7, F3)** screen and choose the output that is set to be calibrated. By selecting "calibrate" as the output all outputs of interest may be selected. When calibration is completed, the operator will return the outputs to their original assignment.

The **D-A CALIBRATION** screen will then be used to complete the calibration procedure.

```

output scaling  5:SDRY
-----
Calibrate D/A Outputs
Output Offset   Gain
-----
  1  1.8000    0.7000
  2  1.8000    0.7000
  3  1.8000    0.7000
  4  1.8000    0.7000
**Set Output-F3-Calibrate**
-----
MAIN / BACK SAVE  NO:  0.1
FS F1: 0%  F5: 100%  O2:  0.0 %
-----
Mon Jan 01 01:13:03 2001
  
```

This screen provides a section that is used to record the zero signal corrections (zero offset) and a second area to record the 100% signal corrections (Gain) for each of the four output signals that may be defined to develop a voltage or current signal.

Since this is a Digital to Analog conversion, the calibration will require the completion of a simple “trial and error” procedure. The operator will observe the results of a “zero” or “span”(Gain) signal generated by the analyzer to the remote recording device and select a correction factor. The operator will save this value and then observe the results on the attached remote recording device.

The process of selection and saving for “zero” and “span” will be repeated until a satisfactory calibration is achieved. For 0-1VDC, 0-5VDC, 0-10VDC and a 0-20 mA outputs the Offset and Gain values are independent and do not interact. With the 4-20 mA output, the “Offset (zero)” and “Gain (span)” values interact and may require a few more trials.

The following is a table of typical values that can be used for start points for offsets and gains for different output types

OUTPUT	OFFSET	GAIN
0-20 ma	0.000	0.927
4-20 ma	1.820	0.740
0-1 V	1.300	0.820
0-5 V	1.100	0.820
0-10 V	1.050	0.820

- Procedure

3.4.1 From the Main Menu press **F5,F7,F3**, to obtain following screen:

assignment		1: SARA	⏏
Output	Signal		
1	NO		
2	NOx		
3	NO2		
4	SamplePres		
		NO: -375.0	
		O2: 0.1 %	

3.4.2. Use the \uparrow to highlight the outputs that require calibration.

3.4.3. Press enter so you provide access to all the menu of signals that are available.
(Real Time, NO, NOx, Calibration, Sample Pressure, etc.)

3.4.4. Select Calibration and press **ENTER** to complete the selection.
Note: In the example below only Output 1 will be calibrated
Record the name of these signals, they will be restored.

assignment		1: SARA	⏏
Output	Signal	mA	
1	Calibrate		
2	NOx		
3	NO2		
4	SamplePres		
		NO: 0.1	
		O2: 0.0 %	
CAI Tel. (800) 959 0959			

Note: Any or all of the four outputs can be selected for calibration. This screen will not be used again until calibration has been completed.

3.4.5. Press **BACK** to return to the SYSTEM SETUP screen (**Main,F5, F7**)

3.4.6. Press **F8** to obtain the following screen

output scaling			
Calibrate	D/A	Outputs	
Output	Offset	Gain	mA
1	1.8000	0.7000	
2	1.8000	0.7000	
3	1.8000	0.7000	
4	1.8000	0.7000	
Set Output-F3-Calibrate			
MAIN / BACK SAVE		NOx: 0.1	
FS F1: 0% F5: 100%			
CAI Tel. (800) 959 0959			

Main, F5, F7, F8

3.4.7. Use the \uparrow to select the desired output press **ENTER**.

3.4.8. Press **F1** to select a ZERO signal and observe the results on the remote device

3.4.9. Change the offset value press **BACK** to save the new value.

3.4.10. Press **F8** to return to the D-A Calibration screen and note the results on the remote device.

3.4.11. Repeat steps 3.4.8 thru 3.4.10 until a satisfactory ZERO calibration is achieved.

3.4.12. Complete steps 3.4.8 thru 3.4.10 for each of the remaining outputs that require calibration.

3.4.13. Press **F5** to produce a full scale (100%) signal.

3.4.14. Use the arrow keys to position the cursor at the require GAIN value.

3.4.15. Observe the results on the remote device and make a correction to the GAIN value for the output of interest. Press **BACK** to save this new value

3.4.16. Press **F8** to return to the D-A calibration screen

3.4.17. Observe the results on the remote device and repeat the steps to change the GAIN value by repeating steps 3.4.14 thru 3.4.16 as needed for each output.

3.4.18. Return to the OUTPUT Assignment screen **F5, F7, F3** from the main menu and change the output signals from CALIBRATE to their original values as defined in step 3.4.1.

3.5 Save Data Archiving Time (Main, F5, F7, F1, F5)

Archive Time is the Time in seconds between each set of data points. If “zero” no data is stored in the SEC data files. The SEC data files are in .CSV format for direct import into Excel. CAI can provide the tools necessary to download these files.

Setup RTC		3: SMAN	☰
F1	Set time		
F2	Set autocalibration time		
F3	Select calibration range		
F4	Autocalibration on/off		
F5	Save Data Archiving Time		
	Archive Time(secs)	10	
F10	Show time		
Archive Interval		N0: -286.8	
0 = Off F5:SAVE		02: 0.1 %	

Use ENTER to change recording time

SEE TABLE A

TABLE A**600 SERIES CLD DATA ARCHIVE FILES**

Time,
Date,
Month,
Year,
Error Index,
TimeStamp,
NO Conc,
NO2 Conc,
NOx Conc,
NH3 Conc,
Concentration,
Detector Volts,
Range,
Auto / Manual,
Span Gas,
Offset,
Gain,
Sample Pressure,
Sample Flow,
Sample EPV Volts,
Air Pressure,
Ozone Flow,
Ozone EPC Volts,
Diode Temp,
Cell Temp,
Oven Temp,
Pump Temp,
Converter Temp,
Dryer Temp,
O2 Detector Temp,
NH3 Conv Temp,
O2 Concentration,
O2 Detector Volts,
O2 Offset,
O2 Gain,
Wet / Dry,
Meas Mode,
Local / Remote,
Converter

3.6 User Digital Outputs

- **Overview**

The 600 CLD Series of instruments have 15 solid state, optically coupled, isolated relays that can be programmed by the operator to indicate the status of numerous digital conditions

The available digital signals consist of a SERVICE group, that can be used to externally monitor a number of conditions to aid in preventative maintenance and diagnostics. **SEE TABLE B & D**

A second STATUS group, is provided and is used to define the operation of the instrument such as Spanning, Zeroing, Calibrating and the current Range (1, 2, 3, 4, AUTO) etc. **SEE TABLE C & D**

The individual output signals can be operator selected and set to a **HOLD** or **CLEAR** mode.

In the **HOLD** mode an activated signal is retained until the operator returns to the **Digital Output Screen** and selects the appropriate output signal and performs a manual CLEAR. After performing a Clear Operation, the operator must press F2 again to put the outputs back into the Hold mode.

User DO I		4: SENO	☰
1	Off		
2	Off		
3	Off		
4	Off	*****	
5	Off	*Set Unused *	
6	Off	*Channels Off*	
7	Off	*****	
F2	Hold / Clear		
F1 8 to 15 DO's		NO: 0.1	
MAIN/BACK to SAVE		O2: 0.0 %	
Mon Jan 01 01:40:39 2001			

In the **CLEAR** mode the signal will automatically change state when the microprocessor detects that the noted condition no longer exists.

User DO II		5: SDRY	☰
8	Off		
9	Off		
10	Off		
11	Off	*****	
12	Off	*Set Unused *	
13	Off	*Channels Off*	
14	Off	*****	
15	Off		
F1 1 to 7 DO's		NO: 0.1	
MAIN/BACK to SAVE		O2: 0.0 %	
CAI Tel. (800) 959 0959			

The operator can select from the following the desired **SERVICE** or **STATUS** groups that are to be digitally monitored.

TABLE B

Index	Service Group	User DO Screen Display
0		
1	Sample Pressure Failure	SampleP
2	Air Pressure Failure	AirP
3	Oven Temp Failure (hclD only)	OvenT
4	Converter Temp Failure	ConvT
5	Pump Temp Failure	PumpT
6	Diode Temp Failure	DiodeT
7	Cell Temp Failure	CellT
8	Peltier Gas Temp Failure (hclD only)	DryT
9	O2 Temp Failure (650 only)	O2T
10	EPC Coil Sample Failure	SEV
11	EPC Coil Air Failure	AEV
12	Range overflow	OR
13	ADC Range Overflow	AO
14	ADC Range Underflow	AU
15	Range 1 is not calibrated	R1NC
16	Range 2 is not calibrated	R2NC
17	Range 3 is not calibrated	R3NC
18	Range 4 is not calibrated	R4NC
19	Reaction chamber pressure	RCP
20	Low concentration Warning	LoC
21	High concentration Warning	HiC
22	NH3 Converter Temp Failure (605 only)	NH3T
23	dummy text for RTC	Off
24	General Alarm	GenAlarm
26	Cal Alarm	CalAlarm

TABLE C

Index	Status Group	User DO Screen Display
25	In Remote	InRem
27	AutoRange	AutoR
28	Range 1	R1
29	Range 2	R2
30	Range 3	R3
31	Range 4	R4
32	In Calibrate	InCal
33	In Zero	Zero
34	In Span	Span
35	In Sample	Sample
36	In NO Mode	InNO
37	In NOx Mode (605 only)	InNOx
38	In Wet Mode (HCLD only)	InWet
39	In Overflow (not used)	InOflow
40	In NH3 Mode (605 only)	InNH3

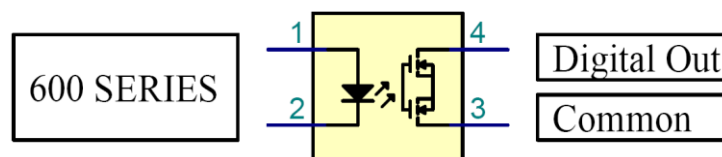
TYPICAL RELAY

These contacts (3, 4) will drive continuously up to 500 MA using a customer voltage supply that does not to exceed 60 VDC.

• **OPERATION**

Use **(Main, F5, F9)** to select the first seven outputs.
 Use the \uparrow to select the desired output.
 Press ENTER and use \uparrow to select desired item.
 Press ENTER to save selection

Note: The 600 CLD has 15 user selectable isolated digital outputs from the list of 40 in **TABLE B & C**

User DO I	4: SEND	☰
1	Off	
2	Off	
3	Off	
4	Off	*****
5	Off	*Set Unused *
6	Off	*Channels Off*
7	Off	*****
F2 Hold / Clear		
F1 8 to 15 DO's		NO: 0.1
MAIN/BACK to SAVE		O2: 0.0 %
Mon Jan 01 01:40:39 2001		

Press **F1** to observe the remaining eight outputs
 Program as desired per the above

User DO II	5: SDRY	☰
8	Off	
9	Off	
10	Off	
11	Off	*****
12	Off	*Set Unused *
13	Off	*Channels Off*
14	Off	*****
15	Off	
F1 1 to 7 DO's		NO: 0.1
MAIN/BACK to SAVE		O2: 0.0 %
CAI Tel. (800) 959 0959		

3.7 Cal Analog Output: (Main, F5, F8,)

Measure setup 4: SENO	
F1	Lowpass filter Tc
F2	Purge time
F3	T + P compensation
F4	Set dual-mode times
F8	Cal Analog Out On
F9	Ignite on power up
set analog out during cal	NO: 42.5
Tue May 15 08:47:49 2007	

Use F8 to toggle on/off

Normally, during Auto Cal the Sample and Hold Outputs NO, NOx and NO2 are held at the last process value. If Cal Analog Output is set "On" then the values are not held, and the Real Time value is Output.

4.0 CHANGES TO EXISTING FUNCTIONS

4.1 Saved or Outside Limits

During Manual Calibration the following screens will be displayed to indicate the instruments response to the value of the zero or span gas using the amount that the operator defined in the deviation table.

Manual Zero 3:SMAN	
Zero gas. Use F3 To Toggle Diagnostics Cal Via *Using Current Temp & Press* ***Saved Current***	
NOx - 0.00 Range1: 100.0ppm	
F1 Save value	NOx: -0.0
F2 Man. Cal. Menu	O2: 0.0 %
Thu May 15 06:16:17 2008	

Manual Span 1:SARA	
Span gas. Use F3 To Toggle Diagnostics Cal Via *Using Current Temp & Press* Outside Deviation Limits	
NOx 0.08 Range1: 100.0ppm	
F1 Save value	NOx: 0.1
F2 Man. Cal. Menu	O2: 0.0 %
Thu May 15 06:18:22 2008	

The above is shown using Zero Gas

From Measurement use: **F5 “Zero” or F6 “Span”**
 From Main Menu use: **F4, F2, F1 “Zero” or F2 “Span”**

4.2 Calibration Deviations.

MAIN, F5, F2, F2 Deviations, F3 Measuring Deviations.

Setup 5: SWET			Setup 1: SARA		
Deviations[%]			Measuring deviation[%]		
	absolute	relative			
Range1:	10.00	10.00	Range1:	1.00	
Range2:	10.00	10.00	Range2:	1.00	
Range3:	10.00	10.00	Range3:	1.00	
Range4:	10.00	10.00	Range4:	1.00	
NOx: -0.0			NOx: 0.0		

Note: These screens are used by the operator to define the maximum acceptable limits of the Zero and Span gas for both Manual and Automatic Calibrating.

4.3 Flow Zero or Span

Some analyzers have the above and the ability to flow Zero and Span Gas.

Manual calib 3: SMAN		Manual calib 1: SARA	
F1 Cal zero	0.08	F1 Cal zero	0.08
F2 Cal span	ZERO	F2 Cal span	SPAN
F3 Toggle zero		F3 Toggle zero	
F4 Toggle span		F4 Toggle span	
F5 Measurements		F5 Measurements	
F6 Cal zero 02		F6 Cal zero 02	
F7 Cal span 02		F7 Cal span 02	
F8 Range Up **	F7 Range Down	F8 Range Up **	F7 Range Down
Range1: 100.0ppm	NOx: 0.1	Range1: 100.0ppm	NOx: 0.1
	O2: 0.0 %		O2: 0.0 %
CAI Tel. (800) 959 0959		Thu May 15 06:22:23 2008	

The above is shown using Zero/SPAN Gas

From Cal Screen use: **F2 or Main or Back**

From Main Menu use: **F4, F2**

4.4 Reset Calibration Values

When the re-set calibrations value function is used all recorded deviations will be set to zero

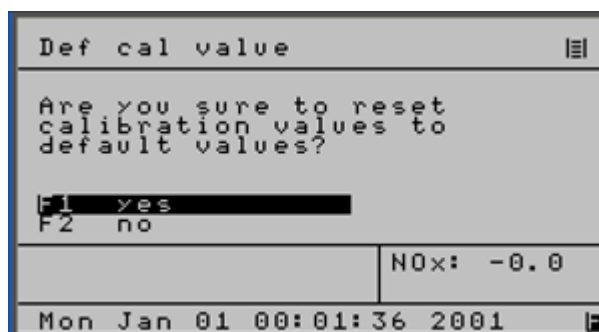

Main, F4,F5

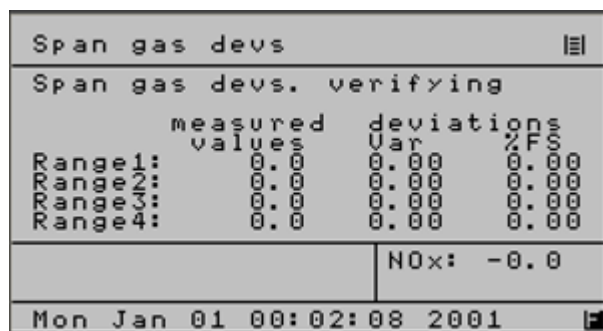

Main,F4 F3, F4
(Used to observe Auto Cal Results)

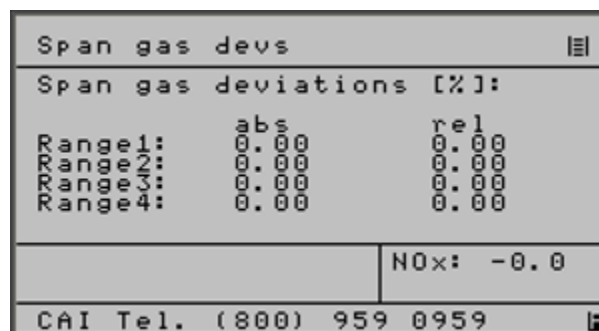

Main, F4, F3, F2
(Used to observe Manual Cal results)

The above are the new deviations after the operator elects to re-set the calibration values

TABLE D**600 SERIES CLD IO CHART****28 PIN MAIN CONNECTOR ASSIGNMENTS**

AO = Analog Output, OC= Open Collector, SV = Solenoid Valve TTL = Transistor Logic

OPTO I/O	Signal Type	600 CLD/HCLD Analog		Levels
ALG 1		pin #		
COM	A Output	1	GND (Isolated analog)	<u>Isolated AI</u>
0	A Output	2	User Defined AO-1	1v,5v,10v,mA
1	A Output	3	User Defined AO-2	1v,5v,10v,mA
2	A Output	4	User Defined AO-3	1v,5v,10v,mA
3	A Output	5	User Defined AO-4	1v,5v,10v,mA
DIG 1		Digital		
COM	D Output	6	GND (Digital)	
0	D Output	7	Sense Auto Range	TTL-low true
1	D Output	8	Sense Range 1	TTL-low true
2	D Output	9	Sense Range 2	TTL-low true
3	D Output	10	Sense Range 3	TTL-low true
	D Output	11	Sense Range 4	TTL-low true
5	D Input	12	Set Auto Range	
6	D Input	13	Control Range 1	
7	D Input	14	Control Range 2	
8	D Input	15	Control Range 3	
9	D Input	16	Control Range 4	
10	D Input	17	Auto Cal	
11	D Input	18	Calibrate	
12	D Input	19	Zero	
13	D Input	20	Span	
14	D Input	21	Sample	
15	SPARE			
DIG 2				
0	D Output	22	Zero Gas Flow	OC (24vdc if internal SV)
1	D Output	23	Span Gas Flow	OC (24vdc if internal SV)
2	D Output	24	Sample Gas Flow	OC (24vdc if internal SV)
3	D Output	25	Local/Remote	TTL-low true
4	D Output	26	Read Cal Mode	TTL-low true
5	D Output	27	Reserved	
6	D Output	28	Reserved	

TABLE D (CONT)**600 SERIES CLD IO CHART****28 PIN AUXILLIARY CONNECTOR ASSIGNMENTS****NO = Normally Open**

OPTO I/O	Signal Type	CLD Analog		LEVELS
ALG 1	Spare	pin #		
COM 4	A Input	1	GND (analog)	
5	A Input	2	External Analog 1	0-10V
6	A Input	3	External Analog 2	0-10V
7	A Output	4	GND (Isolated analog)	
	D Output	5	Relay RTN 1	9,10,11,12 use RTN 1
DIG 3	Alarms	Digital		Status go CLOSED when active Alarms go OPEN when present
COM 0	D Output	6	Relay RTN 2	13,14,15,16 use RTN 2
1	D Output	7	Relay RTN 3	17,18,19,20 use RTN 3
2	D Output	8	Relay RTN 4	21,27,28 use RTN 4
3	D Output	9	User Defined NO Relay 1	
4	D Output	10	User Defined NO Relay 2	
5	D Output	11	User Defined NO Relay 3	
6	D Output	12	User Defined NO Relay 4	
7	D Output	13	User Defined NO Relay 5	
	D Output	14	User Defined NO Relay 6	
8	D Output	15	User Defined NO Relay 7	
9	D Output	16	User Defined NO Relay 8	
10	D Output	17	User Defined NO Relay 9	
11	D Output	18	User Defined NO Relay 10	
12	D Output	19	User Defined NO Relay 11	
13	D Output	20	User Defined NO Relay 12	
14	D Output	21	User Defined NO Relay 13	
15	D Output	22	Reserved Do Not Connect	
DIG 2				
7	D Input	23	Set Wet Mode	
8	D Input	24	Set Overflow	
9	D Input	25	Set NO Mode	
10	D Input	26	Set Remote	
11	D Output	27	User Defined NO Relay 14	
12	D Output	28	User Defined NO Relay 15	