

# 600

SERIES

# FID



# USER'S MANUAL

**Note: For Analyzers Sold After June 2007 Please See Addendum Starting After Page 109 of This Manual**



1312 West Grove Avenue  
Orange, CA 92865-4134  
Phone: 714-974-5560 Fax: 714-921-2531  
[www.gasanalyzers.com](http://www.gasanalyzers.com)



**The Model 600 FID Series Instruments starting with Serial Number U06081 have several new Hardware and Software features. For a complete explanation, see section 13.5 starting on page 93.**



**Safety Alert**  
Caution or Warning



**Temperature Hazard**  
Caution or Warning



**Electrical Shock Hazard**  
Caution or Warning

## Safety Information in this Manual

Note, caution and warning symbols appear on the instrument and throughout this manual to draw your attention to important operational and safety information.

A **“NOTE”** marks a short message to alert you to an important detail.

A **“CAUTION”** safety alert appears with information that is important for protecting your equipment and performance.

A **“WARNING”** safety alert appears with information that is important for protecting you, others and equipment from damage. Pay very close attention to all warnings that apply to your application.



The  symbol (an exclamation point in a triangle) precedes a general CAUTION or WARNING statement.



The  symbol (wavy vertical lines with an under score in a triangle) precedes an elevated temperature hazard CAUTION or WARNING statement.



The  symbol (a lightning bolt in a triangle) precedes an electric shock hazard CAUTION or WARNING statement.

Some or all of the above symbols may appear in this manual or on the equipment. This manual should be consulted whenever one of these symbols is encountered on the equipment.

**ALWAYS REMOVE POWER BEFORE CONNECTING OR DISCONNECTING SIGNAL CABLES OR WHEN SERVICING THE EQUIPMENT.**

**The 600 series MHFID instruments meet or exceed the following directives and standards.**

Application of Council Directive(s):

*Electrical Safety:*

*Low Voltage Directive 73/23/EEC*

*Electromagnetic Compatibility:*

*EMC Directive 89/336/EEC*

Standard(s) to which Conformity is Declared:

*Electrical Safety:*

*Standard for Electrical Equipment for Measurement, Control, and Laboratory Use [EN 61010-1:2001 (2nd Edition)]*

*Electromagnetic Compatibility:*

*EN 61326:1997 Electrical equipment for measurement, control and laboratory use  
- EMC requirements (Amendment A1: 1998 to EN 61326:1997; Amendment  
A2:2001 to EN 61326:1997)*

(This analyzer was tested by ETL to confirm that it is in complete compliance to CE, CSA.  
and the equivalent UL specifications, in accordance with the above directives and standards )

## 600 HFID Quick Start Guide

**Note: DO NOT turn on the sample pump nor introduce any type of sample gas or moisture until the oven has reached an operating temperature of at least 150°C.**

1. Connect analyzer to AC power (230 (±10%) VAC@50/60 Hz) and turn on main power switch located on the back panel.
2. Connect combustion air, combustion fuel, zero gas and span gas through the back panel. Set supply pressures to 20-25 psig.



**Note: This analyzer uses a fuel that contains a FLAMMABLE LEVEL OF HYDROGEN. Any leakage from this fuel can result in an explosion. Carefully check the fuel supply system, to the analyzer for leaks upon installation, before initial start-up. The operating technician should be properly trained for work with hazardous materials.**

**Note: Purge fuel line to remove residual air.**

3. Press and release Ignite **F8** on the main menu to ignite the burner AFTER the oven reaches a minimum temperature of 180°C.

**Note: **Burner Temp Failure** message will be displayed at the bottom of the screen if the Burner fails to ignite.**

4. From Main Menu, press **F4** to choose Calibrations.
5. From the Calibrations menu, press **F2** to choose Manual Calibration.
6. From the Manual Calibration menu, press **F3** to choose Range 3 Select.
7. From the Range Select menu, choose an appropriate range for the span gas that is connected to the analyzer.

**Note: The four ranges are scaled per the customers order. The factory default values are: 30, 300, 3,000, and 30,000 ppm.**

8. Select at least level-2 passwords to flow zero and span gas. (See Section 5.)
9. From the main menu select Calibrations **F4** and then select Manual Calibrations **F2**.
10. Select Flow Zero **F1** or Flow Span **F2** Gas from Manual Calibration menu and observe the displayed concentration.
11. Recalibrate the analyzer if required. (See Section 7.3)

## QUICK MANUAL CALIBRATION

### SETUP

- 1.0 Define span gas concentration for each range F5, F1
- 1.2 Define Calibration path
  - SOLENOIDS** F5, F2, F4
  - PROBE** (pump) F5, F2, F5

### CALIBRATION

- 1.1 Select range (**MEASRMENT** screen)
  - 1.2 Select **ZERO GAS** F4, F1, F1
    - 1.2.1 Save Value F1
  - 1.3 Select **SPAN GAS** F4, F2, F2
    - 1.3.1 Save Value F1

## QUICK AUTO CALIBRATION

### SETUP

- 1.0 Single range
  - .1.1 Define span gas concentration for each range F5, F1
  - 1.2 Define Calibration path
    - .1.2.1 **SOLENOIDS** F5, F2, F4
    - .1.2.2 **PROBE** (pump) F5, F2, F5
  - .1.3 Define Gas flow windows **TIMES** F5, F2, F2,  
(Purge, Calibrating, Verifying, Purge After)
  - .1.4 Define Measuring Deviation F5, F2, F2
  - .1.5 Define Deviations F5, F2, F3  
(% Absolute ((CAI Ideal CAL Curve, m=1.b=0))  
(% Relative ((Last & New ABS Curve))
- 2.0 All Ranges All Channels\*\*
  - 2.1 Define span gas concentration for each range F5, F1
  - 2.2 Define Calibration path
    - 2.2.1 **SOLENOIDS** F5, F2, F4
    - 2.2.2 **PROBE** (pump) F5, F2, F5
  - 2.3 Define Gas flow windows **TIMES** F5, F2, F2,  
(Purge, Calibrating, Verifying, Purge After)
  - 2.4 Define Measuring Deviation F5, F2, F2
  - 2.5 Define Deviations F5, F2, F3  
(% Absolute ((CAI Ideal CAL Curve, m=1.b=0))  
% Relative (Last Cal Curve)
  - 2.6 Define Auto Cal Start Time F5, F7, F1, F1  
(Date, Hour, Frequency)

### CALIBRATION

- 1.0 Single range
  - 1.1 Select /range (**MEASRMENT** screen)
  - 1.2 **AUTOMATIC CALIBRATION** F4, F1  
(Instrument flows zero & span gas & saves value if operator defined deviation requirements are realized)
- 2.0 All ranges
  - .2.1 **AUTO CAL ENABLED** F5, F7, F1, F4  
(Calibration per real-time clock F5, F7, F1, F3)



## FILTER HOUSING MAINTENANCE

- 1) Whenever the Filter Element is replaced ALWAYS apply a fairly liberal coating of silicone lubricant to the threads of the Filter Housing before re-assembly to prevent galling and seizing of the threads.

NOTE: Use a silicone lubricant that is free of Hydrocarbons to eliminate measurement errors and contaminate the analyzer

- 2) ALWAYS, use a second wrench on the body of the Filter Housing when attempting to inspect or replace the filter.
- 3) NEVER attempt to disassemble the Filter Housing while it is hot. Always allow it to cool to room temperature before attempting any maintenance.
- 4) NEVER attempt to re-assemble the Filter housing when it is hot. Re-assembly must ONLY be performed when the analyzer is at room temperature.
- 5) DO NOT over-tighten. The sealing of the Filter Housing is accomplished by the o-ring. Re-assembly should be made 'just past finger tight' and only when the Filter Housing is at room temperature.

**TABLE OF CONTENTS**

*Low Voltage Directive 73/23/EEC* ..... d

*EMC Directive 89/336/EEC*..... d

**FILTER HOUSING MAINTENANCE**..... **h**

**1. Introduction**..... **1**

    1.1. Overview ..... 1

    1.2. Unpacking Instructions..... 1

    1.3. Reporting Damage..... 1

    1.4. Contact Information..... 1

    1.5. Warranty Certificate ..... 2

    1.6. Possible Explosion Hazard ..... 3

    1.7. Electrical Shock Hazard ..... 3

    1.8. Fuel Requirements..... 3

    1.9. Potential Sample Pump Damage ..... 3

    1.10. Removing Protective Caps..... 3

**2. Features**..... **4**

    2.1. Description ..... 4

    2.2. Features-General..... 4

    2.3. Model 600 HFID Specifications..... 5

**3. Installation**..... **6**

    3.1. General ..... 6

    3.2. Site and Mounting ..... 6

    3.3. Sampling System ..... 8

    3.4. Required Gases and Gas Handling Equipment..... 8

    3.5. Gas Connections ..... 8

    3.6. Sampling Requirements..... 9

        3.6.1. Filtration..... 9

        3.6.2. Condensation ..... 9

        3.6.3. Presence of Corrosive Gases ..... 9

        3.6.4. Gas Temperature ..... 9

        3.6.5. Pressure and Flow Rates..... 9

        3.6.6. Exhaust Port..... 10

**4. Basic Operation** ..... **11**

    4.1. Display (Measurement Screen)..... 11

    4.2. Keypad..... 12

        4.2.1. Operation with the Selector Bar and the Arrow Keys ..... 12

        4.2.2. Operation with the Function Keys ..... 12

        4.2.3. Enter Key..... 12

<b>5.</b>	<b>Password and Operating Level Menu Structure .....</b>	<b>13</b>
5.1.	Operating levels .....	13
5.1.1.	Password Level Menu .....	13
5.2.	User Functions (Level 1) .....	14
5.3.	Advanced User Functions (Level 2) .....	14
5.4.	Maintenance Functions (Level 3) .....	14
5.5.	System User Functions (Level 4) .....	14
5.6.	Selection of an Operation Level and Entering a Password .....	15
5.6.1.	<b>F1</b> Enter Password.....	16
5.6.2.	<b>F2</b> Change Password .....	17
5.6.3.	<b>F3</b> Reset Passwords.....	17
5.7.	Available Menus with Access levels.....	18
5.7.1.	Main Menu.....	18
5.7.2.	<b>F4</b> Calibrations .....	19
5.7.3.	<b>F5</b> Setup Menu.....	21
<b>6.</b>	<b>Menus .....</b>	<b>24</b>
6.1.	Main Menu Tree.....	25
6.2.	Measurement Menu Tree.....	26
6.3.	Calibration Menu Tree.....	28
6.4.	Setup Menu Tree .....	29
6.5.	Password Menu Tree.....	31
<b>7.</b>	<b>Menu Function Descriptions .....</b>	<b>32</b>
7.1.	<b>F1</b> Measurements Menu .....	32
7.1.1.	(Measurement) <b>F3</b> Diagnostics.....	32
7.1.2.	(Measurement) <b>F4</b> C1/C3 .....	33
7.1.3.	(Measurement) <b>F5</b> Toggle Zero.....	33
7.1.4.	(Measurement) <b>F6</b> Toggle Span.....	33
7.1.5.	(Measurement) <b>F7</b> Standby .....	34
7.1.6.	(Measurement) Select Range .....	34
7.2.	<b>F3</b> Diagnostics.....	36
7.3.	<b>F4</b> Calibrations Set Up.....	36
7.3.1.	Entering the Span Gas Concentration. ....	36
7.3.2.	Selecting the Path for Calibration Gas Introduction.....	37
7.3.3.	Selecting the Range to be Calibrated. ....	37
7.3.4.	<b>F2</b> Automatic Calibration.....	37
7.3.4.1	Setting the Analyzer's Internal Clock and Calendar. ....	37
7.3.4.2	Defining the Calibration Schedule.....	38

7.3.4.3	Defining the Ranges to be Calibrated.....	38
7.3.4.4	Enabling the Autocalibration Sequence.....	38
7.3.4.5	Entering the Automatic Calibration Span Gas Concentration.....	39
7.3.4.6	Calibration Gas Introduction/Automatic Calibration Sequence.....	39
7.3.4.7	Setting of Automatic Calibration Times.....	40
7.3.4.8	Measuring Deviations.....	40
7.3.4.9	Deviations.....	41
7.4.	Manual Calibration.....	41
7.4.1.	Zero Calibration.....	41
7.4.2.	Span Calibration.....	41
7.4.3.	Calibration Verification (Manual Mode).....	41
7.4.4.	(Calibrations) <b>F4</b> Check Calibration.....	42
7.4.5.	(Calibrations) <b>F5</b> Reset Calibration Values.....	43
7.4.6.	(Calibrations) <b>F6</b> Calibration Range Selection.....	44
7.5.	<b>F3</b> Display Deviations.....	46
7.5.1.	Zero Gas Deviations.....	46
7.5.2.	Span Gas Deviations.....	47
7.5.3.	Verifying Deviations Zero.....	47
7.5.4.	Verifying Deviations Span.....	48
7.6.	<b>F5</b> Setup.....	49
7.6.1.	Entering the Span Gas Concentration.....	49
7.6.2.	<b>F2</b> Calibration Settings.....	50
7.6.2.1	<b>F1</b> Times.....	50
7.6.2.2	<b>F2</b> Measuring Deviations.....	50
7.6.2.3	<b>F3</b> Deviations.....	51
7.6.2.4	<b>F4</b> Calibrations via Valves/Probe.....	51
7.6.3.	<b>F3</b> Range Limits.....	52
7.6.3.1	Setting Full Scale Range Values.....	52
7.6.3.2	Auto Range Switching Levels.....	52
7.6.4.	Alarms.....	53
7.6.4.1	<b>F1</b> Temperatures and Concentration Alarms (T/C Alarms).....	53
7.6.4.2	<b>F2</b> Pressure Alarms.....	53
7.6.4.3	<b>F3</b> EPC Coil Alarms.....	54
7.6.5.	<b>F5</b> Password.....	54
7.6.6.	<b>F6</b> Linearization.....	55
7.6.6.1	Change Linearization Coefficients.....	55
7.6.6.2	Display Raw Value.....	56
7.6.7.	<b>F7</b> System Settings.....	56
7.6.7.1	Real Time Clock.....	57
7.6.7.2	System Setup <b>F1</b> Real Time Clock.....	57
7.6.7.3	<b>F2</b> TCP/IP Settings.....	58
7.6.7.4	<b>F3</b> Output Assignment.....	58

7.6.7.5	F4	Output Range.....	59
7.6.7.6	F5	Status Line ON/OFF .....	59
7.6.7.7	F7	Autostart.....	59
7.6.8.	F8	Measure Settings .....	60
7.6.9.	F10	Version .....	61
7.6.10.	F6	Remote / Manual Control .....	62
7.6.11.	F7	Standby .....	62
7.6.12.	F8	Ignition .....	63
<b>8.</b>		<b>Functional Description.....</b>	<b>64</b>
8.1.		Operating Principle .....	64
8.2.		Burner Assembly.....	64
8.3.		Flow System .....	64
8.4.		Sample Supply .....	65
<b>9.</b>		<b>Analyzer Components .....</b>	<b>66</b>
9.1.		Rear Panel .....	66
9.2.		Internal Component Locations .....	67
9.2.1.		Model 600 HFID Interior Layout.....	67
9.2.2.		Oven Compartment Layout.....	69
<b>10.</b>		<b>Operation.....</b>	<b>71</b>
10.1.		Startup .....	71
10.2.		Shutdown Procedure.....	72
<b>11.</b>		<b>Troubleshooting .....</b>	<b>73</b>
11.1.		Troubleshooting-Disassembly Procedures.....	73
11.1.1.		Oven Burner Assembly Filter Unit/Filter Removal .....	73
11.1.2.		Flow System/Fuel and Burner Air Supply. ....	73
11.2.		Troubleshooting Guide.....	74
11.3.		Error Messages.....	75
<b>12.</b>		<b>AK Protocol Format.....</b>	<b>76</b>
12.1.		Serial Interface and AK-Commands.....	76
12.2.		Interface Parameters .....	76
12.3.		General AK Requirements .....	77
12.4.		Scans.....	77
12.4.1.		AKON: Measured concentration value.....	77
12.4.2.		AEMB: Set measuring range.....	77
12.4.3.		AMBE: Measuring range limit.....	77
12.4.4.		AKAK: Calibration gas concentrations .....	78
12.4.5.		AMBU: Upper and lower range switchover values for auto range.....	78
12.4.6.		ASTZ: Normal device status .....	78

12.4.6.1	Possible states: .....	78
12.4.7.	ASTF: Error status .....	79
12.4.8.	AKEN: Device identification .....	79
12.4.9.	ARMU: Raw value .....	79
12.4.10.	ATEM: Temperatures .....	79
12.4.11.	ADRU: Pressures .....	79
12.4.12.	ADUF: Flows .....	80
12.4.13.	AGRD: Polynom coefficients .....	80
12.4.14.	AANG: Deviation from zero point after autocalibration .....	80
12.4.15.	AAEG: Deviation from end point after autocalibration .....	80
12.4.16.	AFDA: Purge and Autocalibration times .....	80
12.4.17.	APAR: Request Autocalibration tolerance values .....	80
12.4.18.	AKAL: Deviations from calibration .....	81
12.4.19.	ASYZ: Respond System Time .....	81
12.4.20.	AT90: Respond Lowpass filter time .....	81
12.4.21.	ADAL: Diagnostic alarm limits .....	81
12.4.22.	ACXB: Respond Display Factor .....	81
12.5.	Control commands .....	82
12.5.1.	SRES: Reset .....	82
12.5.2.	SPAU: Pause .....	82
12.5.3.	STBY: Standby .....	82
12.5.4.	SNGA: Open valve for zero gas calibration .....	82
12.5.5.	SEGA: Open valve for end gas calibration .....	82
12.5.6.	SSPL: Purge Analyzer with zero gas .....	82
12.5.7.	SLIN: Linearization mode .....	82
12.5.8.	SATK: Start automatic calibration .....	82
12.5.9.	SEMB: Set measuring range .....	82
12.5.10.	SARE: Auto range on .....	83
12.5.11.	SARA: Auto range off .....	83
12.5.12.	SREM: Remote mode for AK-commands .....	83
12.5.13.	SMAN: Manual control to control device manually .....	83
12.5.14.	SMGA: Start measuring .....	83
12.5.15.	SNKA: Saves measured value as new offset. ....	83
12.5.16.	SEKA: Saves measured value as new span value .....	83
12.5.17.	SHCG: Cutter off .....	83
12.5.18.	SCH4: Cutter on .....	83
12.5.19.	S---: Enable dual measure mode .....	83
12.6.	Settings .....	84
12.6.1.	EKAK: The four span gas concentration values are set .....	84

12.6.2.	EMBE: The four measuring range end values are set.....	84
12.6.3.	EMBU: The upper and the lower range switchover for autorange are set .....	84
12.6.4.	EKEN: Set new device identification .....	84
12.6.5.	EGRD: Set polynom coefficients.....	84
12.6.6.	EFDA: Set autocalibration and purge times.....	84
12.6.7.	EPAR: Set autocalibration tolerance values .....	84
12.6.8.	ESYZ: Set System Time .....	85
12.6.9.	ET90: Set Lowpass Filter Time .....	85
12.6.10.	EDAL: Diagnostic alarm limits.....	85
12.6.11.	ECXB: Set Display Factor .....	85
12.7.	Abbreviations used .....	85
<b>13.</b>	<b>Appendix .....</b>	<b>86</b>
13.1.	Connectors.....	86
13.1.1.	86	
	Note: Analog outputs equal 0-10VDC maximum and Digital outputs 0-5VDC (TTL Levels). Analog inputs 0-10VDC Maximum. DO NOT EXCEED 10VDC on the Analog inputs or damage to the analyzer may occur.	86
	Main Connector (Standard 28 Pin Connector).....	86
13.1.2.	Auxiliary Connector (Standard 28 Pin Connector).....	86
13.1.3.	Digital Outputs – RS-232 (Standard 9 Pin DIN Connector).....	87
13.1.4.	Digital Outputs – TCP/IP (8 Pin RJ-47 Connector).....	87
13.2.	Model 600 HFID Flow Diagrams .....	88
13.3.	Electrical Block Diagram .....	92
13.4.	AC Power 600 HCLD/HFID.....	93
13.5.	Starting With Serial Number U06081 .....	94

**Table of Figures**

Figure 3-1 AC Power Switch, Connector, and Fuse .....7

Figure 3-2 EMI Suppressor.....

Figure 3-3 Sample Gas Bypass Outlet (Vent).....10

Figure 4-1 Measurement Screen .....11

Figure 4-2 Keypad .....12

Figure 5-1 Enter / Change Password.....15

Figure 5-2 Access Level Screens .....16

Figure 5-3 Enter password .....16

Figure 5-4 Passwords.....17

Figure 5-5 Reset Passwords to Factory Defaults .....17

Figure 6-1 .....24

Figure 6-2 Main Menu on Power Up Screen.....24

Figure 6-3 Main User Menu (Level 4) .....24

Figure 6-4 Main Menu.....25

Figure 6-5 Measurement Menu Tree .....26

Figure 6-6 Changing the Ranges.....27

Figure 6-7 Calibration Menu .....28

Figure 6-8 Setup Menu (Page 1) .....29

Figure 6-9 Setup Menu Tree (Page 2) .....30

Figure 6-10 Password Menu Tree .....31

Figure 7-1 Main Menu Screen to Measurement Screen .....32

Figure 7-2 First Diagnostics Screen .....32

Figure 7-3 Second Diagnostics Screen .....32

Figure 7-4 **F4** C1/C3 Selection .....33

Figure 7-5 F5 Toggle Zero Selection .....33

Figure 7-6 Toggle Span Selection .....33

Figure 7-7 **F7** go to Standby .....34

Figure 7-8 Analyzer set to Range 1 .....35

Figure 7-9 Analyzer set to Range 2 .....35

Figure 7-10 Analyzer set to Range 3 .....35

Figure 7-11 Analyzer set to Range 4 .....35

Figure 7-12 Set to Auto-Range.....35

Figure 7-13 Diagnostic screens .....36



Figure 7-14 Auto Calibration Cycle .....	40
Figure 7-15 F4 Check calibration.....	42
Figure 7-16 F5 Reset calibration values .....	43
Figure 7-17 Reset calibration values .....	43
Figure 7-18 Reset calibration values confirmation.....	43
Figure 7-19 Range 1 selection from Calibrations Menu.....	44
Figure 7-20 Range 2 selection from Calibrations Menu.....	44
Figure 7-21 Range 3 selection from Calibrations Menu.....	44
Figure 7-22 Range 4 selection from Calibrations Menu.....	45
Figure 7-23 Auto Range selection from Calibrations Menu .....	45
Figure 7-24 <b>F3</b> Display deviations .....	46
Figure 7-25 Zero gas deviations .....	46
Figure 7-26 Span gas deviations .....	47
Figure 7-27 Verifying Zero Gas Deviations.....	47
Figure 7-28 Verifying Span Gas Deviations.....	48
Figure 7-29 Main menu (User level 4) .....	49
Figure 7-30 Setup menu 1 .....	49
Figure 7-31 Span gas concentrations .....	49
Figure 7-32 Change span gas settings.....	49
Figure 7-33 Change Auto Calibration Settings .....	50
Figure 7-34 Setup-times .....	50
Figure 7-35 Measuring deviations .....	50
Figure 7-36 Absolute versus relative deviations .....	51
Figure 7-37 Calibrations via internal solenoid valves .....	51
Figure 7-38 Calibration via probe .....	51
Figure 7-39 Change Range Limits.....	52
Figure 7-40 Change Upper Range Limits .....	52
Figure 7-41 Change Auto Range Limits.....	52
Figure 7-42 Setup Alarms.....	53
Figure 7-43 Set Temperature Alarms .....	53
Figure 7-44 Select Set Pressure Alarms.....	53
Figure 7-45 Select Set EPC Coil Alarms .....	54
Figure 7-46 Change Linearization Coefficients Screen .....	55
Figure 7-47 Select Range/Linear Coefficients.....	55
Figure 7-48 F2 Display Raw .....	56

Figure 7-49 F7 System Setup Screen.....	56
Figure 7-50 Setup RTC.....	57
Figure 7-51 Set Autocalibration Cal Timing .....	57
Figure 7-52 F4 Autocalibration status .....	57
Figure 7-53 TCP/IP Address.....	58
Figure 7-54 Status Line On/Off .....	59
Figure 7-55 Autostart .....	59
Figure 7-56 Menu Settings Screen .....	60
Figure 7-57 Set Time Constant.....	60
Figure 7-58 Analyzer Information/Version .....	61
Figure 7-59 Device/Software Version .....	61
Figure 7-60 Remote manual control .....	62
Figure 7-61 Standby selection .....	62
Figure 7-62 Standby screen .....	62
Figure 7-63 Ignition.....	63
Figure 9-1 Rear Panel .....	66
Figure 9-2 Model 600 HFID Interior Layout .....	67
Figure 9-3 Model 600 HFID Oven Compartment (Full View) .....	69
Figure 9-4 Oven Compartment (Close up).....	70
Figure 13-1: 600 HFID Standard Analyzer/Without Pump.....	88
Figure 13-2: 600 HFID Standard Analyzer with Pump.....	89
Figure 13-3: 600M-HFID with Non-Methane Cutter Assembly without Pump.....	90
Figure 13-4: 600M-HFID with Non-Methane Cutter Assembly with Pump.....	91
Figure 13-5 Electrical Block Diagram .....	92
Figure 13-6 AC Power .....	93

## 1. Introduction

### 1.1. Overview

Congratulations and thank you! You have just purchased one of the most reliable gas analyzers in the world. Before using the analyzer, please familiarize yourself with its operation by reading this manual. If you have any questions, please do not hesitate to call California Analytical Instruments for assistance. We want you to be a member of our thousands of satisfied customers.

### 1.2. Unpacking Instructions

Open the shipping container and carefully remove the analyzer from the packing materials. Inspect the instrument for any sign of damage. Remove the Top Cover retaining screws. Visually check for loose parts or connectors that are not properly seated. Verify all circuit boards and circuit board connections are secure. If all internal components look normal, re-install the cover.

### 1.3. Reporting Damage

Should there be any apparent damage either to the inside or outside of the instrument due to shipping or handling, immediately notify the shipper. The shipping container or packing materials should be retained for inspection by the shipper.

### 1.4. Contact Information

California Analytical Instruments, Inc.

1312 West Grove Avenue

Orange, CA 92865

714 974-5560

Fax 714 921-2531

Website: [www.gasanalyzers.com](http://www.gasanalyzers.com)

## 1.5. Warranty Certificate

Subject to the exceptions and upon the conditions stated below, California Analytical Instruments (CAI) warrants that the products sold under this sales order shall be free from defects in workmanship and materials for one year after delivery of the product to the original Buyer by CAI and if any such product should prove to be defective within such one year period, CAI agrees, at its option, either (i) to correct by repair or, at CAI's election, by replacement with equivalent product any such defective product, provided that investigation and factory inspection discloses that such defect developed under normal and proper uses, or (ii) to refund the purchase price. The exceptions and conditions mentioned above are as follows:

- a. components or accessories manufactured by CAI which by their nature are not intended to and will not function for one year are warranted only to give reasonable service for a reasonable time; which constitutes reasonable time and reasonable services shall be determined solely by CAI. A complete list of such components and accessories is maintained at the factory;
- b. CAI makes no warranty with respect to components or accessories not manufactured by it; in the event of defect in any such component or accessory CAI will give reasonable assistance to Buyer in obtaining from the respective manufacturer whatever adjustment is authorized by the manufacturer's warranty;
- c. any product claimed to be defective must be returned to the factory transportation charges prepaid and CAI will return the repaired or replaced product freight collect;
- d. if the product claimed to be defective requires on-site repair, such warranty labor will be provided at no charge; however, transportation and living expenses will be charged to Buyer;
- e. if the product is a consumable or the like, it is warranted only to conform to the quantity and content and for the period (but not in excess of one year) stated on the label at the time of delivery or 90 days;
- f. CAI may from time to time provide a special printed warranty with respect to a certain product, and where applicable, such warranty shall be deemed incorporated herein by reference;
- g. CAI shall be released from all obligations under all warranties, either expressed or implied, if any product covered hereby is repaired or modified by persons other than its own authorized service personnel unless such repair by others is made with the written consent of CAI.

IT IS EXPRESSLY AGREED THAT THE ABOVE WARRANTY SHALL BE IN LIEU OF ALL WARRANTIES OF FITNESS AND OF THE WARRANTY OF MERCHANTABILITY AND THAT CAI SHALL HAVE NO LIABILITY FOR SPECIAL OR CONSEQUENTIAL DAMAGES OF ANY KIND OR FROM ANY CAUSE WHATSOEVER ARISING OUT OF THE MANUFACTURE USE, SALE, HANDLING, REPAIR, MAINTENANCE OR REPLACEMENT OF ANY OF THE PRODUCTS SOLD UNDER THIS SALES ORDER. SOME STATES DO NOT ALLOW THE EXCLUSION OR LIMITATION OF INCIDENTAL OR CONSEQUENTIAL DAMAGES, SO THAT THE ABOVE LIMITATIONS OR EXCLUSIONS MAY NOT APPLY. THIS WARRANTY GIVES YOU SPECIFIC LEGAL RIGHTS, AND YOU MAY ALSO HAVE OTHER RIGHTS, WHICH VARY FROM STATE TO STATE.

Representations and warranties made by any person, including dealers and representatives of CAI, which are inconsistent, or in conflict with the terms of this warranty, shall not be binding upon CAI unless reduced to writing and approved by an expressly authorized officer of CAI.

## 1.6. Possible Explosion Hazard



This analyzer uses a fuel that contains a **FLAMMABLE LEVEL OF HYDROGEN**. Any leakage from this fuel can result in an explosion. Carefully check the fuel supply system, to the analyzer for leaks upon installation, before initial start-up, during any maintenance or after the integrity of the system is broken.

Do not apply power to the analyzer or attempt to ignite the burner until performing ALL leak checks and until determining the analyzer environment to be non-hazardous.

Use this analyzer in a **NON-HAZARDOUS** environment only.

This analyzer has not been designed for use with a hazardous sample.

Tampering or use of substitute components may cause a safety hazard. Use only factory authorized replacement parts.



## 1.7. Electrical Shock Hazard

Do not operate without the cover secured. Servicing requires access to live electrical circuits that can cause death or serious injury. Refer servicing to qualified service personnel. For safety and proper performance, connect this instrument to a properly grounded three-wire receptacle.

## 1.8. Fuel Requirements

The CAI factory configures the Model 600 HFID for either 100% Hydrogen or 40%/60% Hydrogen/Helium Fuel. Please make sure to use the **CORRECT** fuel (as specified on the fuel label affixed on the back panel of the analyzer.)



Use of incorrect fuel **WILL** damage the instrument and **COULD** cause an explosion.

## 1.9. Potential Sample Pump Damage

The analyzer can be calibrated using the optional zero and span gas ports located on the back panel. It can also be calibrated using the internal sample pump; **HOWEVER**, care must be taken to assure that the sample pump is not exposed to excessive pressure using this calibration method. Any pressure exceeding 2.0 psig can result in a **NON-WARRANTY** failure.

## 1.10. Removing Protective Caps

Do not apply AC power to this analyzer until removing the plastic ¼-inch caps from the sample/zero/span/fuel fittings on the rear panel. Failure to remove these caps will result in analyzer contamination.

## 2. Features

### 2.1. Description

The CAI Model 600 HFID Heated Total Hydrocarbon Analyzer utilizes a highly sensitive flame ionization detector (FID) for measuring gas Total Hydrocarbon (THC) concentrations in industrial or vehicle emission applications.

The heated sample gas is maintained above its dew point by a self-contained internally adjustable temperature oven. The oven temperature is adjusted at the factory to be controlled at 190 °C. The sample gas is maintained at this elevated temperature until it exits the FID's bypass outlet, thus preventing any loss of hydrocarbon concentration in the sample due to condensation.

### 2.2. Features-General

The Model 600 HFID analyzer has a backlit 3 by 5 inch liquid crystal display and a 20 key data/operation input keypad. The microprocessor-controlled system has 16 digital inputs, 16 digital outputs, 16 analog inputs and 4 analog outputs.

The analyzer has four basic ranges of 30/300/3000/30,000 ppm or 3/30/300/300 ppm that are scaled at the factory per the customer's order. These ranges can be re-scaled in the field at anytime by the user through the analyzer's keypad. The analyzer's analog output signal (0-10VDC, 4-20mA, or 0-20mA) is scaled according to the selected range. The operating range of the analyzer can be selected through the keypad, by a contact closure, via the RS232 or TCP/IP interface or automatically when the analyzer is placed into the 'auto-range' mode of operation.

The analyzer can be manually operated from the keypad or remotely via discrete logic, RS-232C or TCP/IP communications. After turning on the analyzer, it needs at least 30 seconds for initialization. During this time, the screen is illuminated. The analyzer is available with an optional internal heated sample pump, and optional internal zero and span solenoids.

***IMPORTANT TIP: When the analyzer is powered up, it defaults to access level 1 (User). To operate ALL parameters, check the access level. (See Section 5.1.)***

The contents of this operator's manual include:

1. Specifications
2. Installation Requirements, Mechanical and Electrical
3. Operation and Calibration Instructions
4. Functional Explanation of the Electronic Circuitry
5. Electrical Block Diagram

### 2.3. Model 600 HFID Specifications

**DETECTOR:** Flame Ionization Detector (FID)

**CH4/THC RANGES:** : 0-3 PPMC to 3%.C. (Four user definable ranges) (Alternate ranges available on request)

**RESPONSE TIME:** T90 < 1.0 Seconds to 60 Seconds (Adjustable).

**RESOLUTION DETECTION LIMIT:** 10 ppb Carbon - (lowest range (Displays 5 Significant Digits).

**REPEATABILITY:** Better than 0.5% of Full Scale.

**LINEARITY:** Better than 0.5% of Full Scale.

**ZERO and SPAN DRIFT:** Less than 1% of Full Scale per 24 hours

**ZERO and SPAN ADJUSTMENT:** Via front panel, TCP/IP or RS232.

**O2 EFFECT:** Less than 2% with H<sub>2</sub>/He Fuel.

**CH4 EFFECT:** Less than 1.15 Propane

**SAMPLE FLOW RATE:** 1.5 to 3.0 LPM. (Consult factory for other flow rates.)

**INTERNAL SAMPLE FILTER:** 0.1 micron replaceable filter provided.

**FUEL REQUIREMENTS:** 40% H<sub>2</sub>/60% He (120cc/min.) or 100% H<sub>2</sub> (60cc/min.) (specify at time of order)

**FUEL INLET PRESSURE:** 25 psig.

**AIR REQUIREMENTS:** Less than 1 ppm Carbon purified or synthetic air (220 to 300 cc/min).

**AIR INLET PRESSURE:** 25 PSIG.

**FUEL/AIR CONTROL:** Electronic Proportional Pressure Controller.

**READOUT:** As ppm CH<sub>4</sub> or C<sub>3</sub>H<sub>8</sub>

**ANALOG OUTPUT:** Voltage or Current.

**COMMUNICATIONS:** RS232 or TCP/IP

**Discrete Alarms:** General Fault/TTL Logic (Ground True) Calibration Failure/TTL Logic (Ground True).

**HIGH CONCENTRATIONS:** (2 each)/TTL Logic (Ground True).

**DIAGNOSTICS:** Oven Temperature, Burner Temperature, Cutter Temperature, Sample/Fuel/Air Pressure, Flow Rates, and EPC Control Voltages.

**KEYPAD DISPLAYS:** Factory Settings, TCP/IP address, Passwords (4), Scalable Analog Output Voltages, Full Scale Range Select, and Auto Cal Times.

**SPECIAL FEATURES:** Calculated NMHC, Auto Ranging, Auto Calibration (Adjustable through internal clock).

**IGNITION:** Local, Remote, or Automatic.

**DISPLAY:** 3" x 5" Back Lit LCD.

**SAMPLE TEMPERATURE:** Up to 191°C, Non-Condensing (HFID), 85°C Non-Condensing (FID)

**OVEN TEMPERATURE:** 200°C HFID (85°C FID)

**AMBIENT TEMPERATURE:** 5 to 40°C.

**AMBIENT HUMIDITY:** Less than 90% RH (Non-condensing).

**WARM-UP TIME:** 1 Hour.

**FITTINGS:** 1/4 Inch Tube.

**POWER REQUIREMENTS:**

115V 60 Hz (Option: 230V 50 Hz), ±10% , 500 Watts.

**DIMENSIONS:** 5¼ H x 19 W x 23 D (Inches)

**WEIGHT:** 50 Pounds/22.7 Kg.

**SPECIFICATIONS ARE SUBJECT TO CHANGE WITHOUT NOTICE**

## 3. Installation

### 3.1. General

The instrument is designed for industrial applications. These installation instructions are for a typical site. Any questions regarding specific installation situations should be directed to Technical Service of California Analytical Instruments, Inc.

### 3.2. Site and Mounting

***NOTE: The following precautions must be carefully observed:***

1. Select a site free from direct sunlight, radiation from a high temperature surface, or abrupt temperature variations.
2. This analyzer is not suitable for installation outdoors.
3. Select a site where the air is clean. Avoid exposing the instrument to corrosive or combustible gases.
4. The instrument must not be subject to severe vibration. If severe vibration is present, use isolation mounts.
5. The instrument is designed for rack-mounting. Optional rack mount slides are available.
6. Do not install near equipment emitting electromagnetic interference (EMI).

***NOTE: A rear supporting brace or equivalent is required if the optional rack mount slides were not purchased.***



### ***Electrical***

All wiring is connected at the rear of the instrument. The AC power is connected to the power/fuse/switch as shown below:



***The power on/off switch is accessible from the rear of the instrument only. DO NOT mount instrument such that the power on/off switch is inaccessible.***

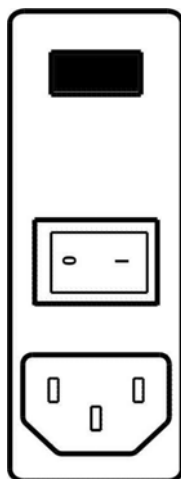

**Figure 3-1 AC Power Switch, Connector, and Fuse**

***NOTE: A defective ground may affect the operation of the instrument. Input and output signals are connected as indicated on page 86. Shielded wiring is recommended for output signals.***



**Replace fuses with recommended fuse size indicated on rear panel of instrument. Replacement with any other size fuse may cause damage to the instrument and possible injury to operating personnel.**

### 3.3. Sampling System

The analyzer's sampling system consists of:

1. An internally mounted in line particulate filter
2. A sample pump (optional)
3. A Sample Capillary that determines the sample flow rate to the FID burner assembly.
4. An Electronic Proportional Control (EPC) valve to regulate the inlet pressure to the sample capillary, to maintain a constant flow rate to the FID burner assembly.

### 3.4. Required Gases and Gas Handling Equipment

1. Air (zero calibration gas, and burner air, < 1 ppm Carbon) in pressurized cylinder.
2. Fuel 40% H<sub>2</sub>/60% He or 100% H<sub>2</sub> in pressurized cylinder. (As Specified)
3. Standard span gas(es) near full-scale concentration (typically 80-95% of the analyzers measuring range) with an air balance, in a pressurized, certified cylinder.
4. Pressure regulators for the zero, span, combustion air, and fuel gas cylinders.
5. Corrosive resistant gas tubing.
6. Heated pump – if not supplied as an analyzer option.
7. Heated sample line.

### 3.5. Gas Connections

The tubing from the sampling system to the gas analyzer should be corrosive resistant material such as Teflon<sup>®</sup> or stainless steel. Do not use rubber or soft vinyl tubing even when the gases sampled are non-corrosive, since readings may be inaccurate due to gas absorption into the piping material. To obtain fast response, the tube should be as short as possible. Optimum tube internal diameter is 0.16 inch (4 mm). Instrument couplings are ¼-inch tube. A sample-gas bypass fitting is located on the rear panel (¼-inch tube). Keep pressure at this outlet at atmospheric level. Vent this gas away from the analyzer to a safe atmospheric discharge.

In general, use heated sample lines for measuring heavy hydrocarbons and for the transportation of hot wet gases. This instrument does not control the temperature in the external heated lines. There are provisions to terminate heated sample lines at the rear of the instrument. However, adequate precautions should be taken to eliminate the possibility of 'cold spots' between the end of the heated sample line and the inlet of the analyzer.

**NOTE: Teflon<sup>®</sup> is a registered trademark of E. I. du Pont de Nemours and Company.**

**NOTE: Be sure tubing and joints are clean. Dust entering the instrument may cause it to malfunction.**

**Also, be sure that all tubing, fittings or other gas handling equipment is completely free of any type of hydrocarbon contamination.**

## 3.6. Sampling Requirements

### 3.6.1. Filtration

The analyzer contains an internal 0.1 micron filter in the sample input. It also has 0.7 micron filters on each of the air, fuel, and optional zero/span gas solenoids valves.

### 3.6.2. Condensation

The analyzer is designed to measure hot wet (raw) sample gases. However, un-heated sample lines (or cold spots in heated lines) will cause the moisture contained in the sample gas to condense. Any liquids entering the analyzer could damage the analyzer. Therefore, sufficient precautions should be taken to insure against the introduction of liquids into the analyzer.

### 3.6.3. Presence of Corrosive Gases

If the sample contains an acid mist, use an acid mist filter, cooler or similar device to remove all traces of the acidic mist. Useful service life of the instrument will be shortened if high concentrations of corrosive gases such as Cl<sub>2</sub>, SO<sub>2</sub>, F<sub>2</sub>, HCl, etc., are present in the sampled gas.

### 3.6.4. Gas Temperature

When measuring high temperature gases, take care that the maximum rating of the instrument 385 °F (196 °C) is not exceeded.

### 3.6.5. Pressure and Flow Rates

Combustion Air and Fuel used by the instrument are controlled by a Electronic Proportional Control (EPC) valve whose function is to maintain a constant pressure for combustion air at the inlet to a capillary. The pressure is factory adjusted for optimum analyzer performance. The supply pressures should be set at approximately 25 PSIG.

The sample entering the instrument is also controlled by a factory set precision EPC valve. The EPC valve is factory set for optimum analyzer performance and is identified as the Sample Pressure on the analyzer's Diagnostic Screen.

If the analyzer does not contain the optional internal sample pump, the sample gas entering the instrument should be between 8 and 25 PSIG with a flow capacity at a minimum of 3 liters/min.

If the analyzer contains the optional sample pump **DO NOT** apply a pressurized sample. The optional pump is capable of drawing a sample through a ¼ inch heated sample line of approximately 85 feet.



***IMPORTANT: If the analyzer contains an optional internal sample pump, the introduction of a pressurized sample gas in excess of 2.0 PSIG will damage the pump.***

***If the analyzer contains optional zero and span solenoid valves, their supply pressures should be set between 20-30 PSIG.***



CAUTION Hot gases are exhausted from the rear panel of the analyzer. Sample Gas Bypass Outlet (1) is located on the rear panel via a ¼ Inch compression fitting.

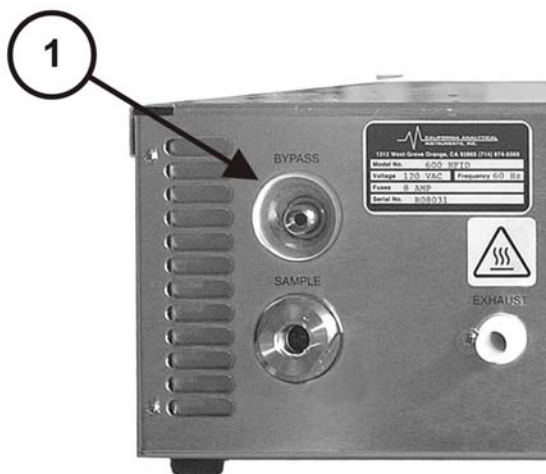
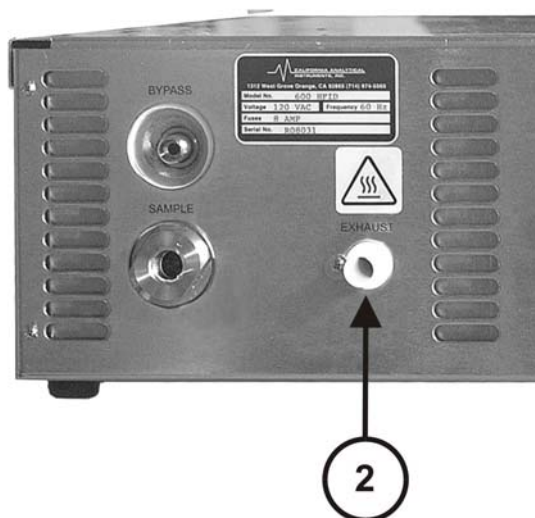

Figure 3-2 Sample Gas Bypass Outlet (Vent)

### 3.6.6. Exhaust Port



1. The Exhaust port (2) is also located on the rear panel (7/16 inch O.D. Teflon sleeve.)
2. Pressure at this outlet should be kept at atmospheric level.
3. **ANY BACKPRESSURE ON THE EXHAUST PORT** will cause an error in reading.
4. The gas exiting the exhaust port will contain moisture that will condense when it leaves the heated oven compartment.
5. Any tubing connected to the Exhaust port must be on a continuous downhill run with a minimum slope of ¼ inch per foot, and sized to prevent any backpressure.

## 4. Basic Operation



The operation of the digital microprocessor conforms to the guidelines of the AK committee, originally developed in the German automotive industry. Via the serial port of the MSR-Card, the analyzer can be remote-controlled by a master computer. The serial communication fully corresponds to the specifications of the AK protocol. TCP/IP communication is also available.

### 4.1. Display (Measurement Screen)

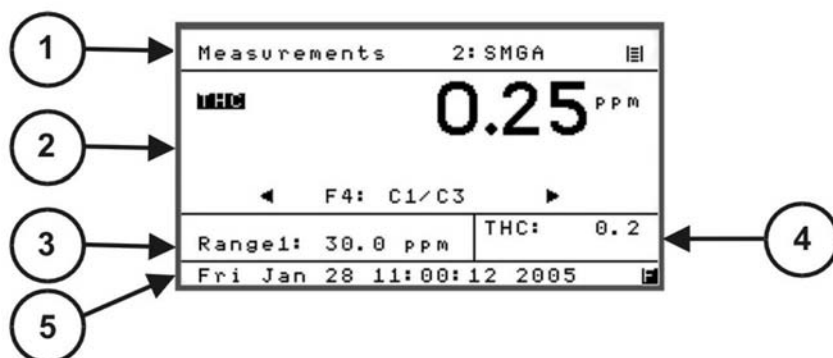
The analyzer's LCD display includes 16 lines with 30 characters each. The display also has background lighting that can be switched on and off via the Display key on the keypad. The following example shows the measurement screen that is formatted into four information areas.



**Figure 4-1 Measurement Screen**

1. This field contains the AK protocol information (i.e. "2: SMGA"). This information is the AK Protocol Command Status and may be toggled on and off from one of the Setup Sub-menus. This status field is also displayed on all other screens.  
The level of Password Entry is shown on the right with 1 to 4 horizontal lines (i.e. | | indicates an access capability for Level 1 "Standard User" and | | | | indicates an access capability for Level 4 "System User").
2. This field displays the concentration of the measured gas as indicated in ppm. It also tells the user whether the THC value is expressed as C1 or C3.
3. This field is a 'Help' field. On the 'Measurements' screen this field shows the analyzer's selected operating range along with its full scale concentration. On other screens, this field provides additional information for the highlighted function shown in field #2.
4. This field is a secondary display of the measured concentration. Regardless of the selected mode or menu, this field is ALWAYS indicated.
5. This field shows the time and date, any error condition, and Function or Numeric Control Indication. The symbol in the bottom right corner indicates the operating mode of the keypad. In the example shown, the keypad is in the Function mode (as indicated by ) . When a numeric input is required, the  will change to an  to indicate the keypad is in the numeric mode and indicates that numeric data is required. At that time, the operating mode of the keypad is automatically switched to input numbers. When completed the keypad is automatically switched back to function mode.

## 4.2. Keypad

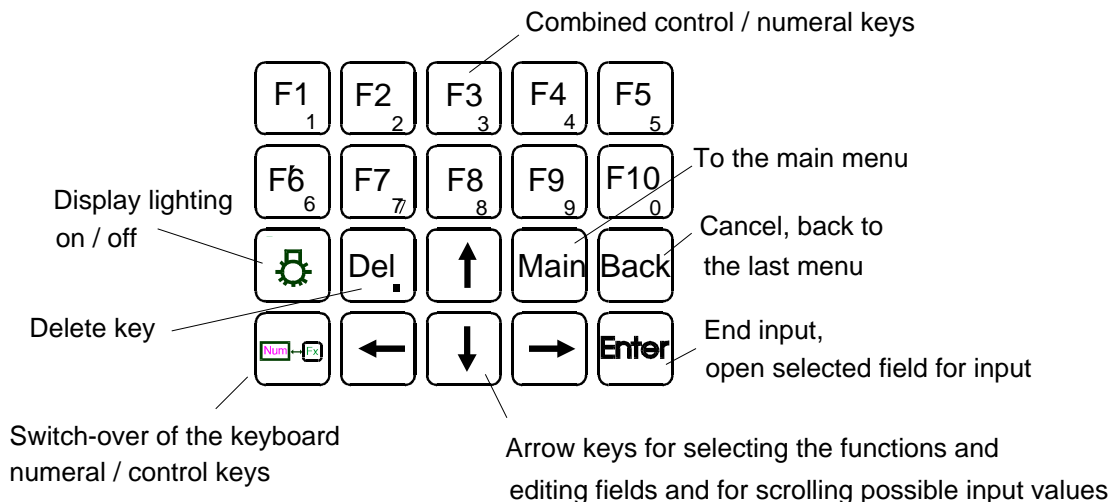

**Figure 4-2 Keypad**

**Note:** You may select the various functions on any menu or sub-menu by either of two methods.

**Method 1:** Operation using the selector Bar and the arrow keys.

**Method 2:** Operation using the function Keys.

### 4.2.1. Operation with the Selector Bar and the Arrow Keys

On any menu screen, the actual cursor position is shown as a black horizontal bar. When operating the unit press the arrow keys to move the Selector Bar up or down, left, or right. The Selector Bar highlights the function that will be selected when the **Enter** key is pressed.

### 4.2.2. Operation with the Function Keys

When using the function keys (**F1** through **F10**), functions may be directly accessed by pressing their corresponding function keys (as indicated at the left edge of the screen.) The use of the arrow keys is not always required unless specifically indicated.

### 4.2.3. **Enter** Key

The **Enter** key is used to change the numeric value of a screen. Whenever a numeric input is required, the Selector Bar will highlight a numeric field. Press **Enter** to activate a flashing cursor. Press the right or left Arrow key to position the cursor under the digit to be changed. (The keypad will now be in the desired numerical mode.) Input the desired numeric value and press **Enter** to index to the next location.

When the last number has been entered, pressing the **Enter** key for the last time will automatically return the keypad to the function mode.

## 5. Password and Operating Level Menu Structure

### 5.1. Operating levels

The analyzer's operation can be divided into four operating levels. The current level is always displayed as a stack of 1 to 4 horizontal bars in the top right corner of the normal measuring screen.

#### 5.1.1. Password Level Menu

In the Password Level menu, you can choose between the following Operating Levels:

- |           |                  |                     |
|-----------|------------------|---------------------|
| <b>F1</b> | User             | (operating level 1) |
| <b>F2</b> | Extended user    | (operating level 2) |
| <b>F3</b> | Maintenance user | (operating level 3) |
| <b>F4</b> | System user      | (operating level 4) |

Next, enter the correct password for the chosen operating level. Use the keypad for entering this number. The default passwords for the CAI analyzers were set at the factory as follows:

User:	111
Extended user:	222
Maintenance user:	333
System:	444

The factory set default setting can be changed by the customer but **ONLY** by a System user.

This manual is written to include the information required by a System User. Depending upon the Operating Level that is currently set on your analyzer, some of the parameters shown in this manual may not appear on your analyzers LCD display. Check the Operating Level at which your analyzer is currently set.

The following is a partial listing of some of the analyzer's available menus. Please notice that all of the menu items for a level 1 Operator are available to a level 4 Operator; however, a level 4 Operator has access to many additional functions.

## 5.2. User Functions (Level 1)

### Main Menu

F1: Measurements  
F3: Diagnostics  
F5: Setup  
F7: Standby  
F8: Ignition

### F5: Setup Menu

F5: Password  
F10: Version

### F5: Password Menu

F1: Enter password  
F3: Reset passwords

## 5.3. Advanced User Functions (Level 2)

### Main Menu

F1: Measurements  
F2: Purge Analyzer  
F3: Diagnostics  
F4: Calibrations  
F5: Setup  
F7: Standby  
F8: Ignition

### F5: Setup Menu

F3: Range Limits  
F5: Password  
F10: Version

### F5: Password Menu

F1: Enter password  
F3: Reset passwords

## 5.4. Maintenance Functions (Level 3)

### Main Menu

F1: Measurements  
F2: Purge Analyzer  
F3: Diagnostics  
F4: Calibrations  
F5: Setup  
F7: Standby  
F8: Ignition

### F5: Setup Menu

F1: Span Gas Concentration  
F3: Range limits  
F5: Password  
F7: System Settings  
F8: Measurement Settings  
F10: Version

### F5: Password Menu

F1: Enter password  
F3: Reset passwords

## 5.5. System User Functions (Level 4)

### Main Menu

F1: Measurements  
F2: Purge Analyzer  
F3: Diagnostics  
F4: Calibrations  
F5: Setup  
F6: Remote/manual  
F7: Standby  
F8: Ignition

### F5: Setup Menu

F1: Span Gas Concentration  
F2: Calibration Settings  
F3: Range limits  
F4: Alarms  
F5: Password  
F6: Linearization  
F7: System Settings  
F8: Measurement Settings  
F10: Version

### F5: Password Menu

F1: Enter password  
F2: Change password  
F3: Reset passwords



## 5.6. Selection of an Operation Level and Entering a Password

After turning on the analyzer, you are in access level 1. To change the access level or to change the passwords from the main menu press the **F5** key to select the Setup menu. Then press **F5** again to select the Password menu.

Main Menu		4: SCH4	☰
F1	Measurements		
F2	Purge analyzer		
F3	Diagnostics		
F4	Calibrations	»	
<b>F5</b>	<b>Setup</b>	»	
F6	Remote/Manual		
F7	Standby		
F8	Ignition		
System settings		CH4: 1.6	
Thu Dec 30 01:20:32 2004			

Setup		1: SARE	☰
F1	Span gas concentrations		
F2	Calibration settings	»	
F3	Range limits	»	
F4	Alarms		
<b>F5</b>	<b>Password</b>	»	
F6	Linearization	»	
F7	System settings	»	
↓F8	Measure settings	»	
Enter and change passwords		THC: 89.4	
Thu Dec 30 01:20:32 2004			

Setup			☰
<b>F1</b>	<b>Enter password</b>		
F2	Change password		
F3	Reset passwords		
Enter password		THC: 0.3	
Fri Jan 28 10:35:53 2005			

Figure 5-1 Enter / Change Password

### 5.6.1. **F1** Enter Password

When you press **F1 Enter Password**, you get the Access Level screen. Select the desired access level and press the corresponding Function Key: Press **F1**, **F2**, **F3**, or **F4** to select the desired access level.

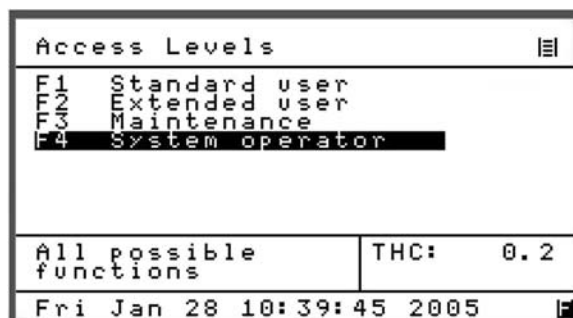

**Figure 5-2 Access Level Screens**

Next, you must enter the correct password for the chosen access level. The passwords for the various operation levels consist of three numbers that must be entered on the numeric keypad. If the password is incorrect, you will be asked to re-enter the password.

**IMPORTANT TIP:** When a new analyzer is powered up, it defaults to access level 1 (User). To operate ALL parameters and gain complete access, select **F4**. Press the **Enter** key to cause the far left displayed asterisk to flash. Then enter 444 (or other chosen password-see below.)

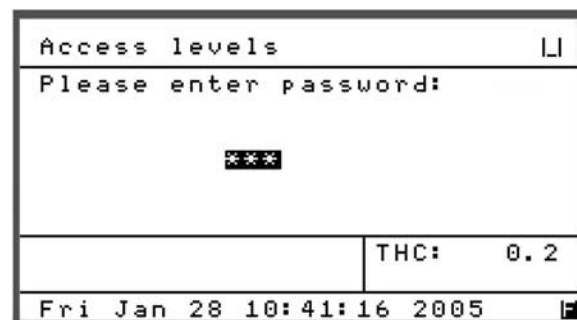

**Figure 5-3 Enter password**

**Note:** for lower access level press **F1**, **F2**, or **F3** and enter:

111	For Standard User:	<b>F1</b>
222	For Extended User:	<b>F2</b>
333	For Maintenance	<b>F3</b>

### 5.6.2. **F2** Change Password

*(Do not attempt to use this function at this time)*

The Factory default passwords are 111, 222, 333, and 444. You may elect to change the passwords to any other three digit number. However, to do this the analyzer MUST BE set to access level 4.

Instead of pressing **F1 Enter Password**, press **F2 Change Password**. Press the arrow key to select the password to be changed. Press the **Enter** key to activate the flashing cursor. Use the numeric keypad to enter the new password. Press the **Enter** key again to save the new password.

Repeat this procedure as desired for all other passwords.

Setup		THC: 0.3
F1 Enter password		
<b>F2 Change password</b>		
F3 Reset passwords		
Enter password		THC: 0.2
Fri Jan 28 10:35:53 2005		Fri Jan 28 10:36:48 2005

Figure 5-4 Passwords

**IMPORTANT TIP:** You MUST remember and record ALL new passwords. If these are lost, you will need to consult the factory for the required password to reset all passwords.

### 5.6.3. **F3** Reset Passwords

The passwords can only be reset, if you are in access level 4. If you have forgotten or lost your customized password, please contact the factory to re-gain access to reset the passwords to the factory default settings.

Setup		1: SARE
F1 Enter password		
F2 Change password		
<b>F3 Reset passwords</b>		
Reset passwords to defaults		THC: 87.6
Thu Dec 30 01:20:32 2004		

Figure 5-5 Reset Passwords to Factory Defaults

## 5.7. Available Menus with Access levels

### 5.7.1. Main Menu

The following is a complete listing of the various Main Menu sub-screens and their assigned access levels.

Level					
4	3	2	1		
X	X	X	X	F1	Measurements (See Section 6.2 for additional sub-menus))
X	X	X	O	F2	Purge Analyzer (No Sub-menu)
X	X	X	X	F3	Diagnostics (No Sub-menu)
X	X	X	O	F4	Calibration (See Section 5.7.2 for additional sub-menus)
X	X	X	X	F5	Setup (See Section 5.7.3 for additional sub-menus)
X	O	O	O	F6	Remote/Manual (No Sub-menu)
X	X	X	X	F7	Standby (No Sub-menu)
X	X	X	X	F8	Ignition (No Sub-menu)

5.7.2. **F4** Calibrations

Level				
4	3	2	1	
X	X	X	O	<b>F1</b> Automatic Calibrations
X	X	X	O	<b>F2</b> Manual Calibrations
				<b>F1</b> Flow Zero Gas
				<b>F1</b> Save value
				<b>F2</b> Close valve
				<b>F2</b> Flow Span Gas
				<b>F1</b> Save value
				<b>F2</b> Close valve
				<b>F3</b> Range Select
				<b>F1</b> Range 1
				<b>F1</b> Measurements
				<b>F2</b> Calibrations
				<b>F2</b> Range 2
				<b>F1</b> Measurements
				<b>F2</b> Calibrations
				<b>F3</b> Range 3
				<b>F1</b> Measurements
				<b>F2</b> Calibrations
				<b>F4</b> Range 4
				<b>F1</b> Measurements
				<b>F2</b> Calibrations
				<b>F5</b> Auto Range
				<b>F1</b> Measurements
				<b>F2</b> Calibrations

5.7.2 **F4** Calibrations (Continued)

Level				
4	3	2	1	
X	X	X	O	<b>F3</b> Display Deviations
				<b>F1</b> Zero Gas Deviations
				<b>F2</b> Span Gs Deviations
				<b>F3</b> Verifying Deviations zero
				<b>F4</b> Verifying Deviations span
X	X	X	O	<b>F4</b> Check Calibrations Values
X	O	O	O	<b>F5</b> Reset Calibrations Values
X	X	X	O	<b>F6</b> Range Select
				<b>F1</b> Range 1
				<b>F1</b> Measurements
				<b>F2</b> Calibrations
				<b>F2</b> Range 2
				<b>F1</b> Measurements
				<b>F2</b> Calibrations
				<b>F3</b> Range 3
				<b>F1</b> Measurements
				<b>F2</b> Calibrations
				<b>F4</b> Range 4
				<b>F1</b> Measurements
				<b>F2</b> Calibrations
				<b>F5</b> Auto Range
				<b>F1</b> Measurements
				<b>F2</b> Calibrations

5.7.3. **F5** Setup Menu

Level				
4	3	2	1	
X	X	O	O	<b>F1</b> Span Gas Concentrations
X	O	O	O	<b>F2</b> Calibrations Settings
				<b>F1</b> Times
				<b>F2</b> Measuring Deviations
				<b>F3</b> Deviations
				<b>F4</b> Calibrate Via Valves
				<b>F5</b> Calibrate Via Probe (Pump)
X	X	X	O	<b>F3</b> Range Limits
				<b>F1</b> Range 1-4
				<b>F2</b> Auto Range
X	O	O	O	<b>F4</b> Alarms
				<b>F1</b> T/C Alarms
				<b>F2</b> Pressure Alarms
				<b>F3</b> EPC Coil Alarms
X	X	X	X	<b>F5</b> Password
				<b>F1</b> Enter Password
				<b>F1</b> Standard User
				<b>F2</b> Extended User
				<b>F3</b> Maintenance
				<b>F4</b> System Operator
X	O	O	O	<b>F2</b> Change Password
				<b>F3</b> Reset Password

5.7.3 **F5** Setup Menu (Continued)

Level				
4	3	2	1	
X	O	O	O	<b>F6</b> Linearization
				<b>F1</b> Change Linear. Coefficients.
				<b>F1</b> Range 1
				<b>F2</b> Range 2
				<b>F3</b> Range 3
				<b>F4</b> Range 4
				<b>F2</b> Display Raw Valves
X	X	O	O	<b>F7</b> System Settings
				<b>F1</b> Real Time-Clock
				<b>F1</b> Set time
				<b>F2</b> Set auto calibration time
				<b>F3</b> Select calibration range
				<b>F4</b> Auto calibration on/off
				<b>F10</b> Show time
				<b>F2</b> TCP/IP
				<b>F3</b> Output Assignments
				<b>F4</b> Output Range
				<b>F5</b> Status Line On/Off
				<b>F7</b> Autostart
				<b>F8</b> Measure Settings
				<b>F1</b> Set dual-mode times
				<b>F2</b> Cutter efficiency
				<b>F3</b> Low pass filter TC
				<b>F4</b> Purge Time
				<b>F6</b> T and P compensation
X	X	X	X	<b>F10</b> Version





## 6. Menus

Upon power up, the CAI logo is first displayed and then the main menu appears as below:

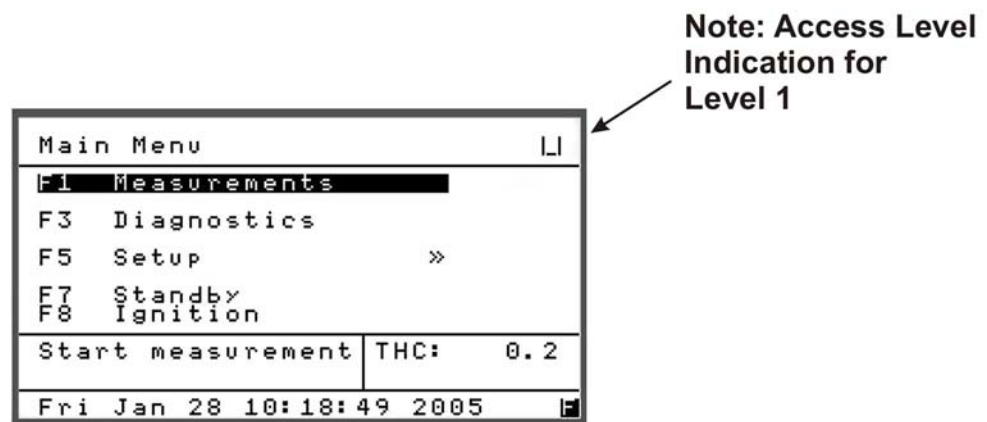

Figure 6-1

### Figure 6-2 Main Menu on Power Up Screen

All functions can be selected with the up or down arrow keys and activated by pressing the **Enter** key, or directly with the function keys **F1** through **F7**. A ">>" to the right of a function means that one or more sub-menus are available. If this sign is missing, the function starts immediately after the activation.

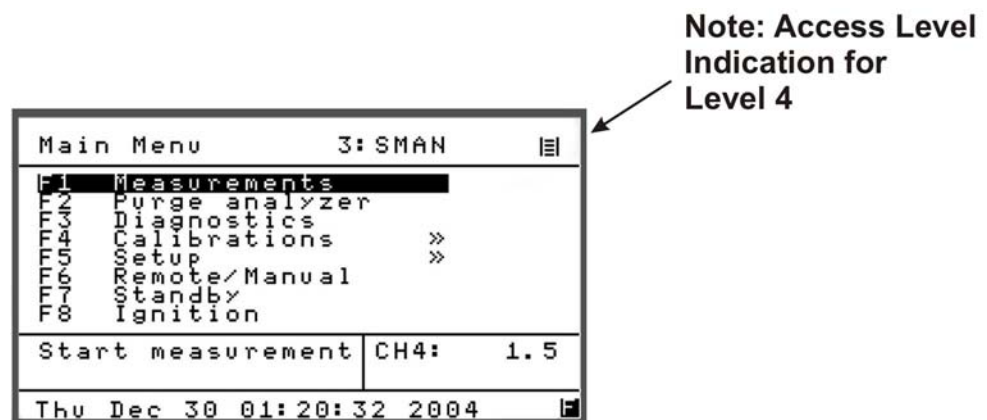

Figure 6-3 Main User Menu (Level 4)

### 6.1. Main Menu Tree

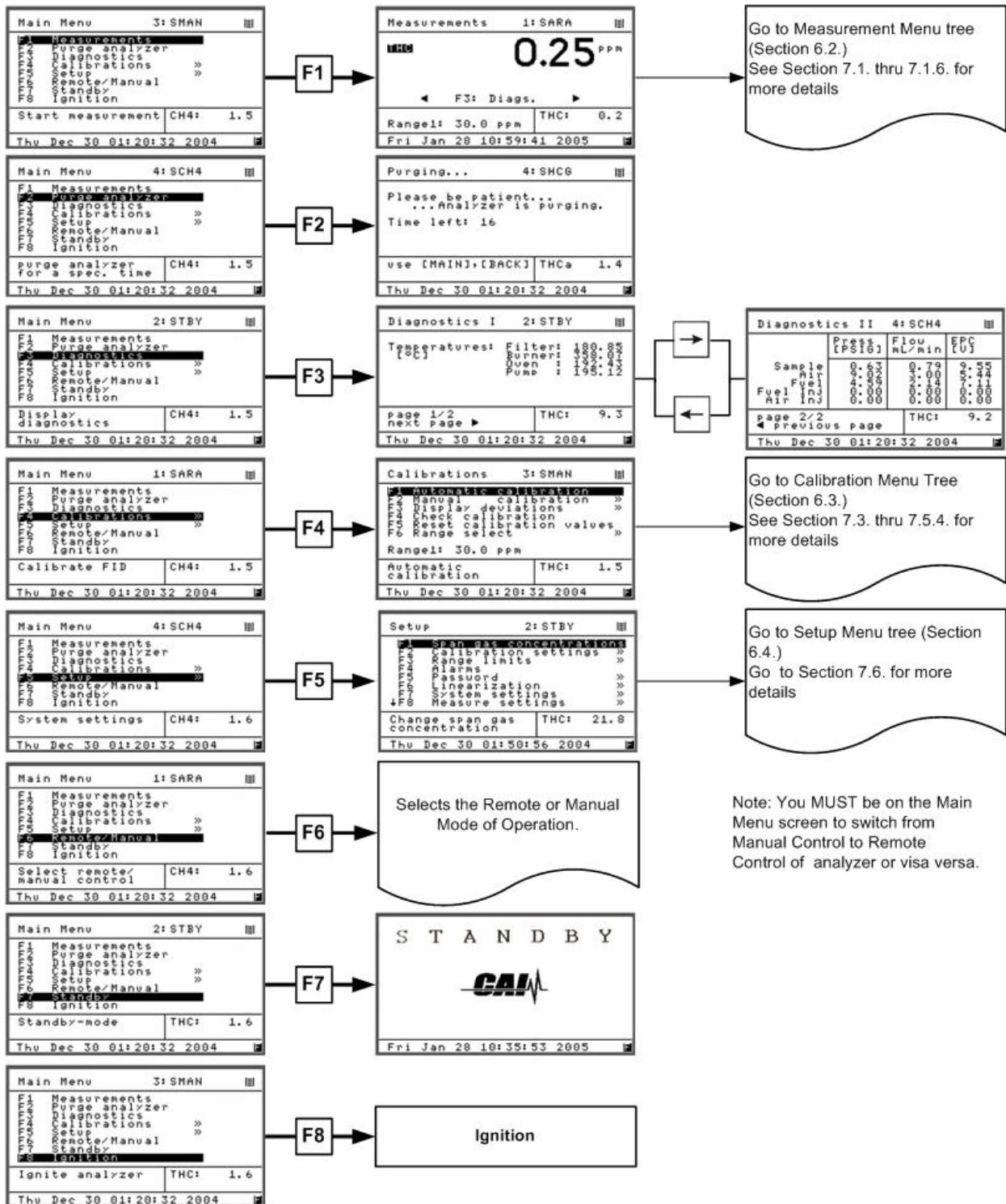

Figure 6-4 Main Menu

### 6.2. Measurement Menu Tree

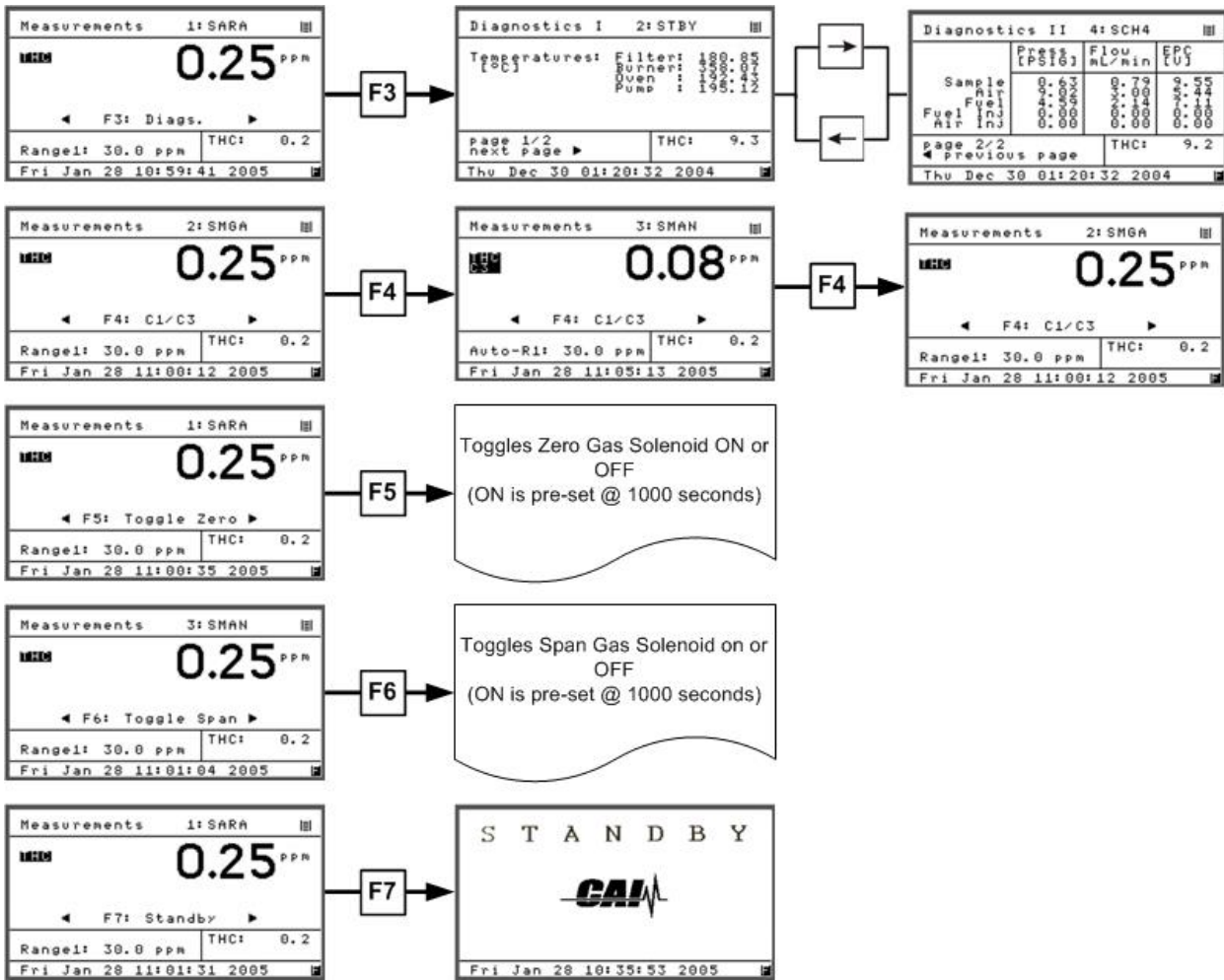

Figure 6-5 Measurement Menu Tree

6.2 Measurement Menu Tree (Continued)

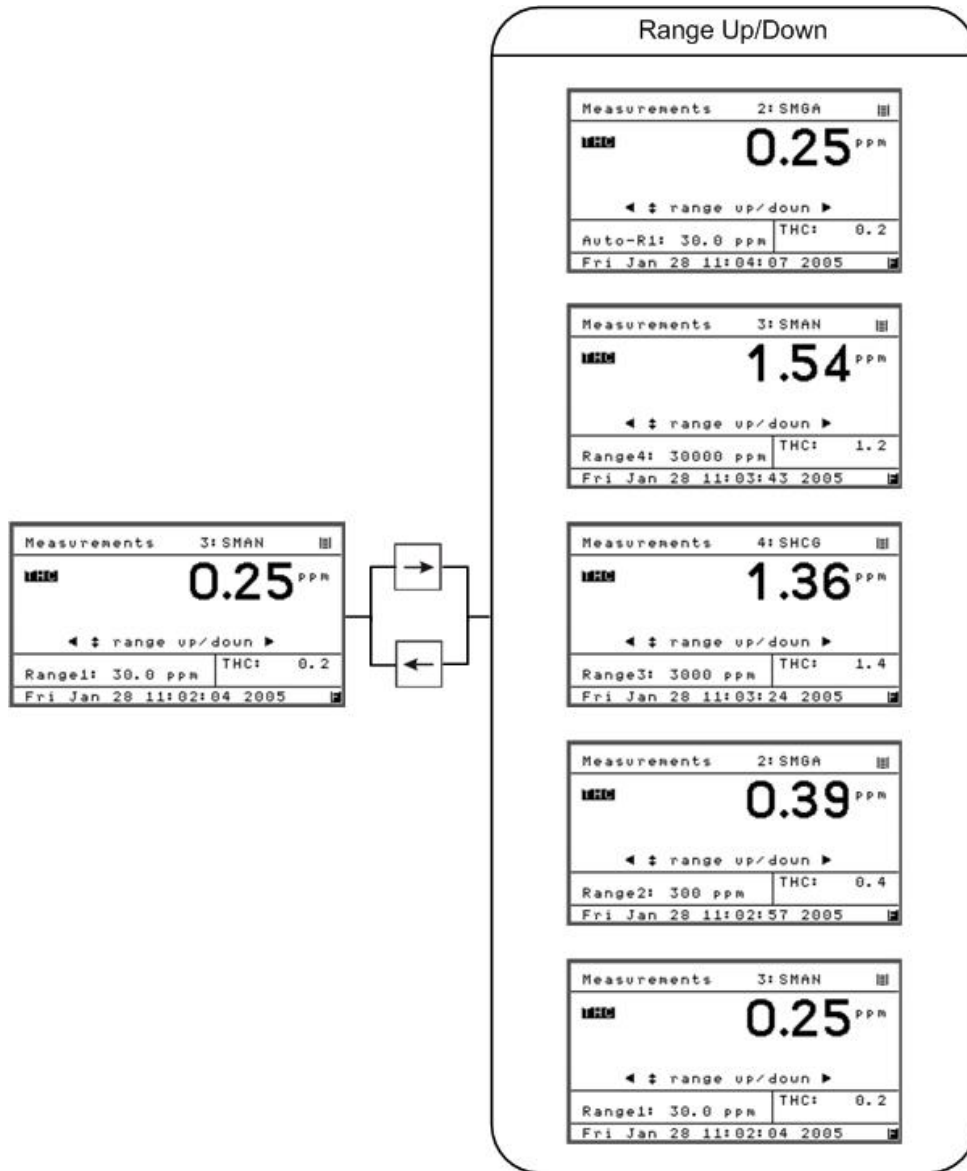

Figure 6-6 Changing the Ranges

### 6.3. Calibration Menu Tree

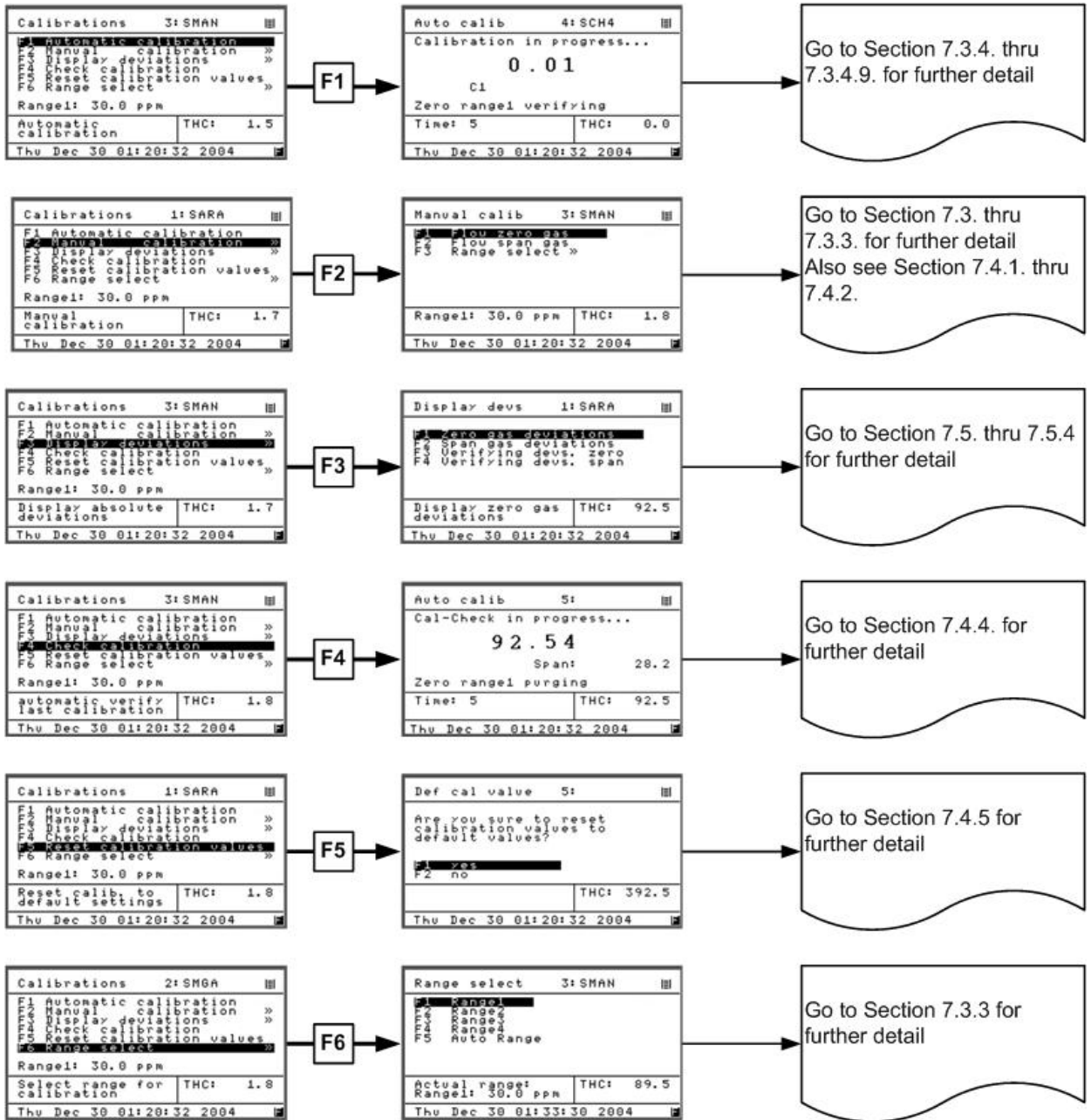

Figure 6-7 Calibration Menu

### 6.4. Setup Menu Tree

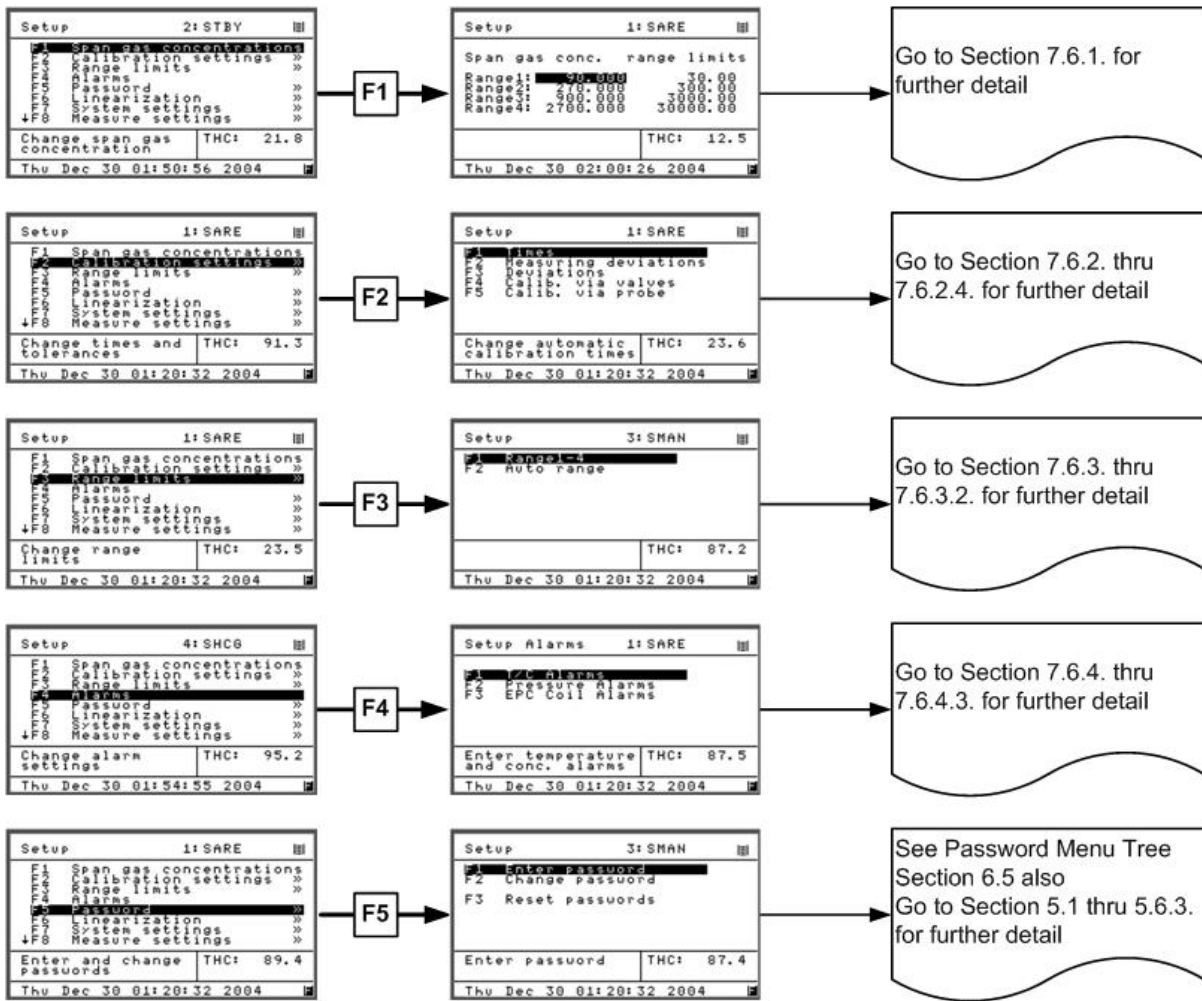

Figure 6-8 Setup Menu (Page 1)

### 6.4 Setup Menu Tree (Continued)

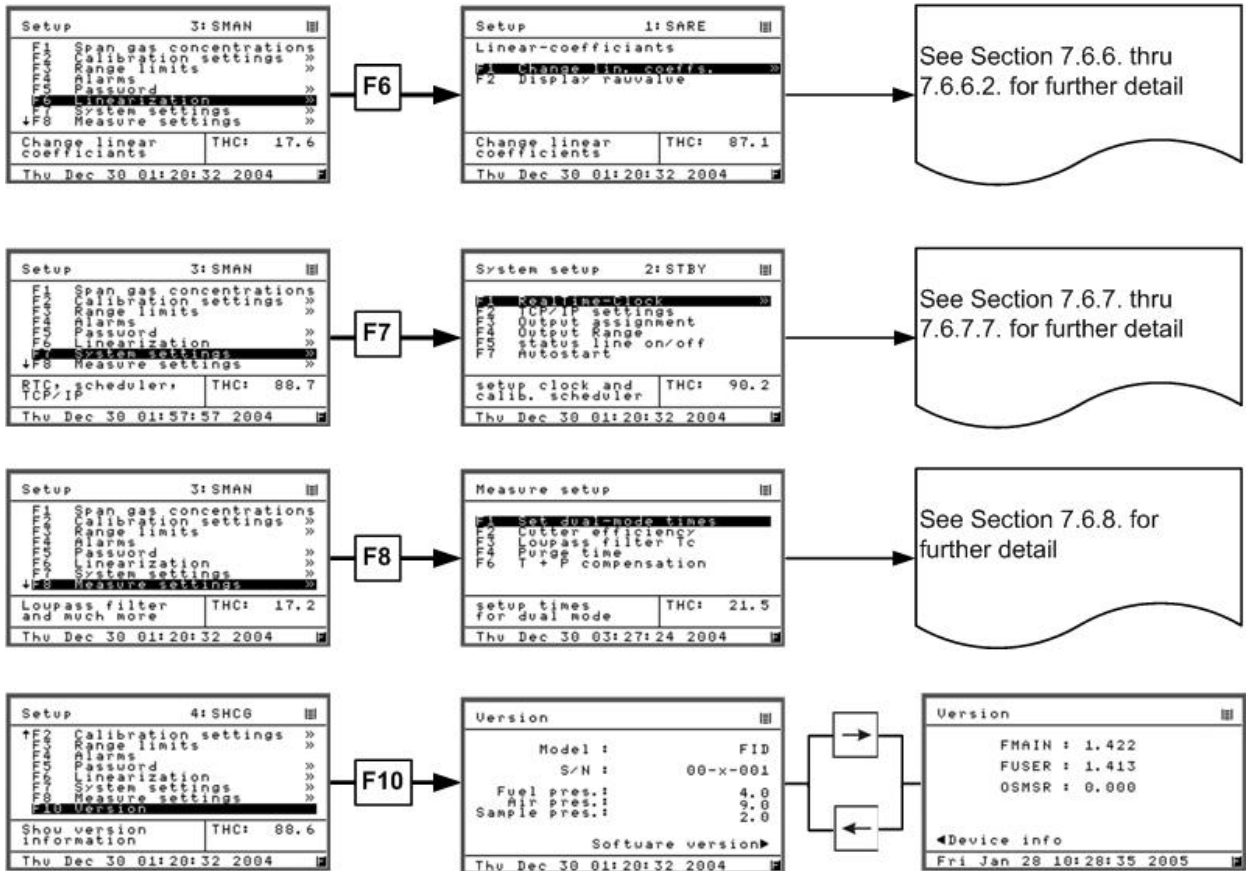

Figure 6-9 Setup Menu Tree (Page 2)



### 6.5. Password Menu Tree

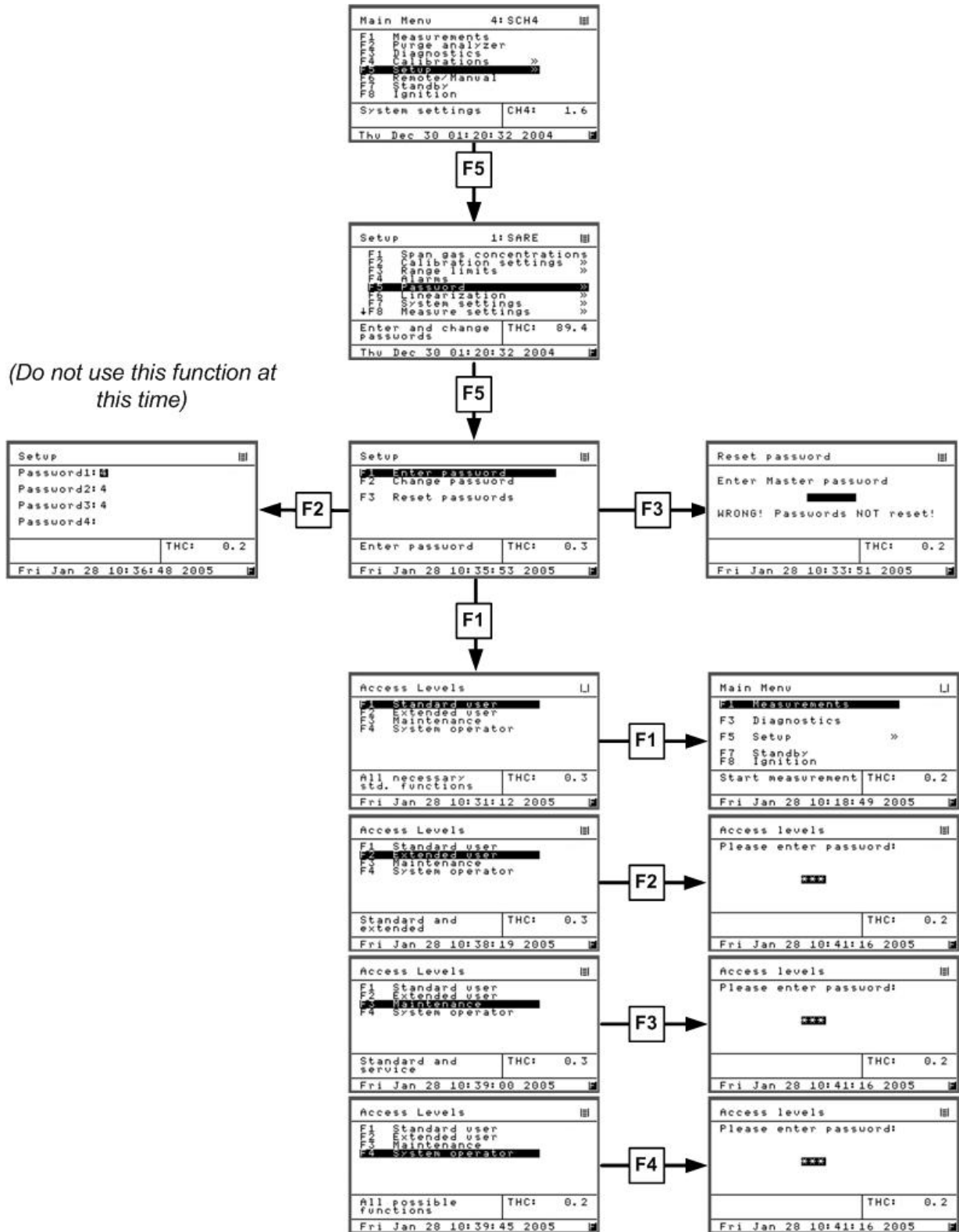

Figure 6-10 Password Menu Tree

## 7. Menu Function Descriptions

### 7.1. **F1** Measurements Menu

The measurements screen is activated by pressing **F1** on the Main Menu screen. Once the Measurement mode is initiated, the LCD displays pertinent gas information and additional sub-menus that are available from the measurement screen. These submenus can be accessed by using the left and right Arrow key. The desired function may then be selected by pressing the appropriate **F** key. Once a sub-menu has been accessed pressing the key labeled **BACK** will return you to the measurement screen. Figures 7-1 thru 7-13

Main Menu 3: SMAN		Measurements 1: SARA	
<b>F1</b> Measurements <b>F2</b> Purge analyzer <b>F3</b> Diagnostics <b>F4</b> Calibrations >> <b>F5</b> Setup >> <b>F6</b> Remote/Manual <b>F7</b> Standby <b>F8</b> Ignition		<b>THC</b> <b>0.25</b> ppm F3: Diags.	
Start measurement	CH4: 1.5	Range1: 30.0 ppm	THC: 0.2
Thu Dec 30 01:20:32 2004		Fri Jan 28 10:59:41 2005	

Figure 7-1 Main Menu Screen to Measurement Screen

#### 7.1.1. (Measurement) **F3** Diagnostics

**F3** activates the diagnostic screen where temperatures, pressures flow rates, and EPC control voltages are displayed in real time. The units are degrees C, psig, ml/min, and volts. Use the arrow key to switch between diagnostic screens.

Diagnostics I 2: STBY	
Temperatures: [°C]	Filter: 180.85 Burner: 300.07 Oven: 192.43 Pump: 195.12
page 1/2 next page ▶	THC: 9.3
Thu Dec 30 01:20:32 2004	

Figure 7-2 First Diagnostics Screen

Diagnostics II 4: SCH4			
	Press [PSIG]	Flow mL/min	EPC [V]
Sample	0.63	0.79	9.55
Air	9.02	3.00	5.44
Fuel	4.59	2.14	7.11
Fuel Inj	0.00	0.00	0.00
Air Inj	0.00	0.00	0.00
page 2/2 ◀ previous page	THC: 9.2		
Thu Dec 30 01:20:32 2004			

Figure 7-3 Second Diagnostics Screen

### 7.1.2. (Measurement) **F4** C1/C3

Press **F4** to toggle between reading Hydrocarbon as C1 or C3.

Measurements 2: SMGA	Measurements 3: SMAN
<b>0.25</b> ppm	<b>0.08</b> ppm
F4: C1/C3	F4: C1/C3
Range1: 30.0 ppm	Auto-R1: 30.0 ppm
THC: 0.2	THC: 0.2
Fri Jan 28 11:00:12 2005	Fri Jan 28 11:05:13 2005

Figure 7-4 **F4** C1/C3 Selection

### 7.1.3. (Measurement) **F5** Toggle Zero

Press **F5** to toggle zero gas on. Pressing **F5** again will toggle the zero gas off. Zero gas is automatically toggled off after 1000 seconds.

Measurements 1: SARA
<b>0.25</b> ppm
F5: Toggle Zero
Range1: 30.0 ppm
THC: 0.2
Fri Jan 28 11:00:35 2005

Figure 7-5 F5 Toggle Zero Selection

### 7.1.4. (Measurement) **F6** Toggle Span

Press **F6** to toggle span gas on. Pressing **F6** again will toggle the span gas off. Span gas is automatically toggled off after 1000 seconds.

Measurements 3: SMAN
<b>0.25</b> ppm
F6: Toggle Span
Range1: 30.0 ppm
THC: 0.2
Fri Jan 28 11:01:04 2005

Figure 7-6 Toggle Span Selection

### 7.1.5. (Measurement) **F7** Standby

Pressing **F7** puts the analyzer in Standby.

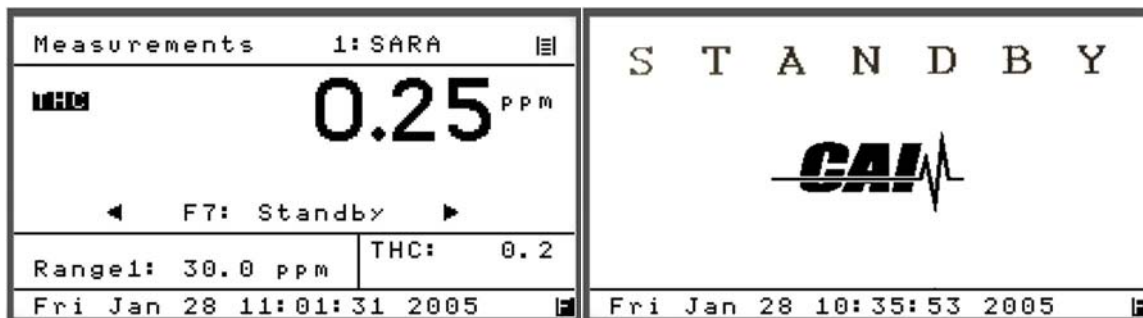

Figure 7-7 **F7** go to Standby

### 7.1.6. (Measurement) Select Range

There are three methods to select the analyzers operating range.

1. Via the measurements screen using the Arrow key. (See this Section)
2. Via the Calibrations menu and selecting the Manual Calibrations sub-menu **F2**. (See Section 7.3.3.)
3. Via the Calibrations Menu and selecting the Range Select sub-menu **F6** (See Section 7.4.6.)

With the up or down arrow keys, ranges 1 to 4 can be selected. Selecting any specific range will disable the auto range capability. Continuing to press the arrow keys will recycle the analyzer back to auto range. The selected range and/or auto range is displayed on the measurement screen. If the full scale range limit is exceeded (while not in the auto range mode), a warning message "Over Range" will appear on the screen.

Measurements	3: SMAN	
	<b>0.25</b>	PPM
◀ ⚡ range up/down ▶		
Range1: 30.0 ppm	THC: 0.2	
Fri Jan 28 11:02:04 2005		

Figure 7-8 Analyzer set to Range 1

Measurements	2: SMGA	
	<b>0.39</b>	PPM
◀ ⚡ range up/down ▶		
Range2: 300 ppm	THC: 0.4	
Fri Jan 28 11:02:57 2005		

Figure 7-9 Analyzer set to Range 2

Measurements	4: SHCG	
	<b>1.36</b>	PPM
◀ ⚡ range up/down ▶		
Range3: 3000 ppm	THC: 1.4	
Fri Jan 28 11:03:24 2005		

Figure 7-10 Analyzer set to Range 3

Measurements	3: SMAN	
	<b>1.54</b>	PPM
◀ ⚡ range up/down ▶		
Range4: 30000 ppm	THC: 1.2	
Fri Jan 28 11:03:43 2005		

Figure 7-11 Analyzer set to Range 4

Measurements	2: SMGA	
	<b>0.25</b>	PPM
◀ ⚡ range up/down ▶		
Auto-R1: 30.0 ppm	THC: 0.2	
Fri Jan 28 11:04:07 2005		

Figure 7-12 Set to Auto-Range

## 7.2. **F3** Diagnostics

Pressing **F3** from the Main Menu activates the Diagnostics function. The Diagnostics screens may be accessed from **EITHER** the Main Menu or the Measurements screen. The Diagnostic I screen indicates the operating temperature for the inlet filter assembly, Burner's flame, Oven compartment, and the optional Heated Sample Pump. Diagnostic screen II provides pressures, flows, and EPC voltages for Sample, Air, and Fuel.

Diagnostics I 2:STBY		Diagnostics II 4:SCH4		
Temperatures: [°C]	Filter: 1800.85	Press [PSIG]	Flow mL/min	EPC [V]
	Burner: 3000.07	Sample	0.79	9.55
	Oven: 192.43	Air	3.00	5.44
	Pump: 195.12	Fuel	2.14	7.11
		Fuel Inj	0.00	0.00
		Air Inj	0.00	0.00
page 1/2	THC: 9.3	page 2/2	THC: 9.2	
next page ▶		◀ previous page		
Thu Dec 30 01:20:32 2004		Thu Dec 30 01:20:32 2004		

Figure 7-13 Diagnostic screens

## 7.3. **F4** Calibrations Set Up

**BEFORE** any attempt is made to calibrate (zero and/or span) the analyzer you **MUST** first enter the concentration of the span gas that is to be used to span and calibrate each range.

### 7.3.1. Entering the Span Gas Concentration.

From the Main Menu, press **F5** for the Setup Menu. Press **F1** to view the screen that shows the span gas concentration for each range. Use the Down Arrow as required selecting the range that is to be calibrated, Press the **Enter** key to activate the flashing cursor. Use the Right Arrow key to position the flashing cursor under the digit that is to be changed. Input the new value of that digit. Repeat this process as required.

**Note: Entering more than one span gas concentration MANDATES a separate calibration for each range.**

**In the Automatic Calibration mode, entering a span gas concentration for only a single range will result in the span calibration of all ranges as based upon the theoretical range ratio of all other ranges with respect to the range for which the span gas concentration was entered.**

### 7.3.2. Selecting the Path for Calibration Gas Introduction.

Introduction of the calibration gases can be by way of optional built-in zero and span solenoid valves; through the sample inlet port via the optional built-in sample pump or external solenoid valves. The analyzer provides output signals to control external calibration solenoid valves provided by the customer.

**Note: If the analyzer contains a built-in sample pump it is imperative that a maximum inlet pressure of 2 PSI is NOT exceeded to prevent damage to the pump.**

When introduction of the zero and span calibration gases will be by way of the analyzer's optional built-in zero and span solenoid valves, select 'Calibration via valves'. 'Calibration via valves' is selected by pressing **F5** on the Main Menu. From the Setup Menu press **F2**. Next press **F4** on the Calibrations Menu to select 'Calibration via Valves' (or **F5** for 'Calibration via Probe').

Whenever it is necessary (or desirable) to introduce the zero and span calibration gases through the analyzers sample inlet port, you must select 'Calibration via Probe'. In this mode, the analyzer will provide 'ground true' output signals to control the customer supplied, external zero, and span solenoid valves.

### 7.3.3. Selecting the Range to be Calibrated.

There are three methods to select the analyzers operating range.

1. Via the measurements screen using the Arrow key (See Section 7.1.6.)
2. Via the Calibrations menu and selecting the Manual Calibrations sub-menu **F2**. (See this Section)
3. Via the Calibrations Menu and selecting the Range Select sub-menu **F6** (See Section 7.4.6.)

From the Main Menu press **F4** to select the Calibration Menu. Press **F2** to select the Manual Calibration Menu. Press **F3** for range select. Press **F1**, **F2**, **F3**, or **F4** to select the range that is to be calibrated.

After selecting the range that is to be calibrated, press **F2** again to return to the Calibration Menu.

### 7.3.4. **F2** Automatic Calibration

Before any attempt is made to setup (or use) the Automatic Calibration feature of the analyzer, perform the sections for manual Calibrations as outlined in Section 7.4.1. through 7.4.4.

#### 7.3.4.1 Setting the Analyzer's Internal Clock and Calendar.

From the Main Menu press **F5** for Setup and then **F7** for System Settings. Press **F1** for Real Time Clock. Press **F1** for Set Time.

Use the Arrows, numeric keypad, and **Enter** Key to input the time of day based on a 24-hour clock. Be sure to enter all numbers in the indicated format.

**PRESS **F1** TO SAVE ALL ENTRIES.** Press the **Back** key to exit this screen. Press **F1** to re-access the set time screen and verify all entries are correct.

#### 7.3.4.2 Defining the Calibration Schedule.

From the Main Menu press **F5** for the Setup Menu. Press **F7** for System settings. Press **F1** to select the Real Time Clock.

Press **F2** to select Set Autocalibration time. Input the desired Automatic Calibration schedule using the Arrow, numeric keypad and enter keys.

**Note: The Start Time format is 'hours: minutes: seconds' of a 24 hour clock. For example, (18:15:00) would be 15 minutes after 6PM.**

Press **F1**, **F2**, or **F3** to complete and save the schedule.

Press the **Back** key to exit the screen. After exiting press **F2** to reenter the screen and verify all entries.

#### 7.3.4.3 Defining the Ranges to be Calibrated.

From the Main Menu press **F5** for the Setup Menu. Press **F7** for System Settings and then press **F1** for the Real Time Clock. Press **F3** for Select Calibration Range. Press the **Enter** key to obtain a flashing cursor. Use the numeric keypad to select range 1, 2, 3, or 4. Press the **Enter** key to store the selected range.

#### 7.3.4.4 Enabling the Autocalibration Sequence

From the Main Menu press **F5** for the Setup Menu. Press **F7** for System settings. Press **F1** to select the Real Time Clock. Press **F4** for Autocalibration ON/OFF.

**Note: Each time the **F4** key is pressed the Automatic Calibration schedule will be enabled or disabled.**



#### 7.3.4.5 Entering the Automatic Calibration Span Gas Concentration.

From the Main Menu, press **F5** for the Setup Menu. Press **F1** to view the screen that shows the span gas concentration for each range. Use the Down Arrow as required selecting the range that is to be calibrated, Press the **Enter** key to activate the flashing cursor. Use the Right Arrow key to position the flashing cursor under the digit that is to be changed. Input the new value of that digit. Repeat this process as required.

**Note: Entering more than one span gas concentration MANDATES a separate calibration for each range.**

**In the Automatic Calibration mode, entering a span gas concentration for only a single range will result in the span calibration of all ranges as based upon the theoretical range ratio of all other ranges with respect to the range for which the span gas concentration was entered.**

#### 7.3.4.6 Calibration Gas Introduction/Automatic Calibration Sequence.

Selecting the Path for Calibration Gas Introduction during the Automatic Calibration Sequence.

Introduction of the calibration gases can be way of optional built-in zero and span solenoid valves; through the sample inlet port via the optional built-in sample pump or external solenoid valves (provided by the customer). The analyzer provides output signals to control external calibration solenoid valves.

**Note: If the analyzer contains a built-in sample pump it is imperative that a maximum inlet pressure of 2 PSIG is NOT exceeded to prevent damage to the pump.**

From the Main Menu press **F5** for the setup menu then press **F2** for the Calibration settings.

Now press **F4** for 'Calibration via valves' or **F5** for 'Calibration via probe'. If probe calibration is selected the pump will be used to introduce calibration gases.

### 7.3.4.7 Setting of Automatic Calibration Times

The setting of the Automatic Calibration Times is also known as setting the zero and span gas flow duration.

1. Automatic calibration requires the operator to define several segments of the calibration sequence including:
2. Purge time—the length of time required to flow the zero and span gases in order to achieve a stable analyzer response before actual signal calibration.
3. Calibration time—the time required to permit the analyzer to realize a true value on which to calibrate.
4. Verification time—the time required for the microprocessor to verify the calibration as described in Section 7.5.3 and 7.5.4.
5. Final purge (aka purge after)—a final purge of the analyzer before resuming normal measure.

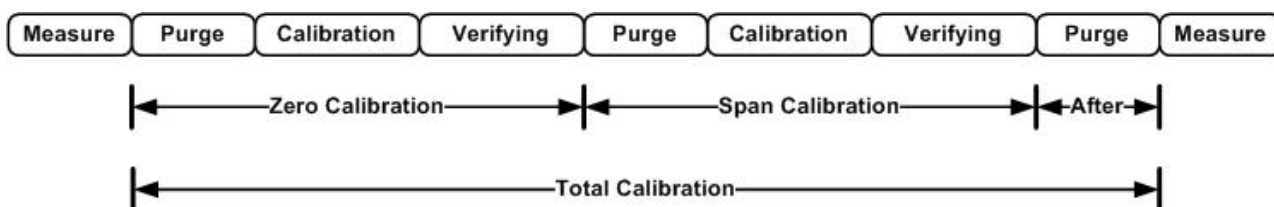

Figure 7-14 Auto Calibration Cycle

From the Main Menu press **F5** to access the setup menu. Press **F2** for Calibration settings. Press **F1** for times.

Use the Arrows, numeric keypad and **Enter** key to input the appropriate times for each cycle. This information will be used in both zero and span phases of the Automatic Calibration Cycle.

### 7.3.4.8 Measuring Deviations.

Measuring Deviations are a quality check of the zero and span gas calibration performed during the Automatic Calibration Sequence. It is executed during the verifying phase of the automatic calibration cycle.

**Note: They are not applicable to manual calibrations.**

A single Measuring Deviation for comparison of the analyzers measured response to the resultant zero and span calibration is user definable and is expressed as a percentage of full scale.

From the Main Menu press **F5** for the Setup Menu. Press **F2** for Calibration Settings. Press **F2** again for Measuring Deviation. Press the **Enter** to obtain a flashing cursor. Use the Arrows, numeric keypad, and Enter key to input the desired allowable Measuring Deviation for each range (expressed as a percent of full scale.)

### 7.3.4.9 Deviations

Deviations are defined as a quality check of the most recent zero and span calibration compared to previous calibration curves.

There are two types of curves:

1. An 'Absolute' Curve—this is a perfect curve whose slope is 1.0 and its intercept is exactly zero.
2. A 'Relative' Curve—this curve is generated using the customer supplied calibration gases and is re-defined by each calibration.

Each time the analyzer is calibrated the **NEW Relative Curve** is compared with the **OLD Relative Curve**, as well as against the permanently stored **Absolute Curve**. If the user definable preset deviations limits (expressed as a percent of full scale) are exceeded the analyzer will:

1. Notify the user with a **Calibration Failure** message.
2. Continue to report all measured data against the last successful calibration.

## 7.4. Manual Calibration

### 7.4.1. Zero Calibration

From the Main Menu press **F4** to select the Calibration Menu. Press **F2** to select Calibration. Press **F1** to flow the zero gas. (Verify the zero gas is flowing at this time.)

After the analyzer's displayed concentration has stabilized, press **F1** again to save the new span value. (Also see Calibration Verification, Section 7.4.3.)

**Note: Exiting the Zero Gas Screen by pressing the Back Key will also turn OFF the Zero Gas Solenoid.**

### 7.4.2. Span Calibration

From the Main Menu press **F4** to select the Calibration Menu. Press **F2** to select Manual Calibration. Press **F2** to flow the span gas. (Verify the appropriate span gas is flowing at this time.)

After the analyzer's displayed concentration has stabilized, press **F1** to save the new span value. (Also see Calibration Verification, Section 7.4.3.)

### 7.4.3. Calibration Verification (Manual Mode).

The concentration for the zero and span gas that was indicated on the screen during the recent zero and span calibration was predicated upon the analyzer's PREVIOUS zero and span calibration. When you pressed **F1** to save the new value, the microprocessor's memory for the zero and span gas actual measured concentration was updated.

To verify that the NEW zero and span gas values have been properly saved you must perform a Calibration Verification. From the Main Menu press F4 for the Calibration Menu. Press **F2** for Manual Calibration. Press **F1** to flow zero gas. Confirm the indicated zero gas concentration is acceptable. If it is **NOT**, repeat the zero and span calibrations as required.

Press the **Back** key to return to the Manual Calibration screen. Press **F2** to flow span gas. Confirm the indicated span concentration is acceptable. If it is **NOT** repeat zero and span calibrations as required.

#### 7.4.4. (Calibrations) **F4** Check Calibration

This is a default calibration. Pressing **F4** activates an automatic zero and span check for verification.



Auto calib 5: 	
Cal-Check in progress...	
92.54	
Mode: THC	Span: 28.2
Zero range1 purging	
Time: 5	THC: 92.5
Thu Dec 30 01:20:32 2004 	

Figure 7-15 F4 Check calibration

### 7.4.5. (Calibrations) **F5** Reset Calibration Values

There is a default calibration. Press **F5** to reset calibration values to the default calibration values. **F1** confirms and the calibration values are reset to default calibration values. **F2** leaves this menu without resetting to default values. This function will overwrite all calibrations with factory values. In addition, the linearization polynom will be overwritten with the factory values.

Calibrations 1: SARA		☰
F1	Automatic calibration	
F2	Manual calibration	>>
F3	Display deviations	>>
F4	Check calibration	
F5	Reset calibration values	>>
F6	Range select	>>
Range1: 30.0 ppm		
Reset calib. to default settings	CH4:	1.8
Thu Dec 30 01:20:32 2004		

Figure 7-16 F5 Reset calibration values

Def cal value 5:		☰
Are you sure to reset calibration values to default values?		
F1	yes	
F2	no	
		THC: 392.5
Thu Dec 30 01:20:32 2004		

Figure 7-17 Reset calibration values

Def cal value 2: STBY		☰
Calibration values reset to default values!		
		THC: 3.8
Thu Dec 30 01:20:32 2004		

Figure 7-18 Reset calibration values confirmation

### 7.4.6. (Calibrations) **F6** Calibration Range Selection

There are three methods to select the analyzers operating range.

1. Via the measurements screen using the Arrow key. (See Section 7.1.6.)
2. Via the Calibrations menu and selecting the Manual Calibrations sub-menu **F2**. (See Section 7.3.3.)
3. Via the Calibrations Menu and selecting the Range Select sub-menu **F6**. (this Section)

Range select 3: SMAN		Range select 4: SHCG	
F1 Range1 F2 Range2 F3 Range3 F4 Range4 F5 Auto Range		Selected range: Range1: 30.0 ppm	
Actual range: Range1: 30.0 ppm	THC: 89.5	F1 Measurements	THC: 94.8
Thu Dec 30 01:33:30 2004		Thu Dec 30 01:43:30 2004	

Figure 7-19 Range 1 selection from Calibrations Menu

After selecting range one press **F1** to go to measurements or **F2** to go to calibrations.

Range select 2: STBY		Range select 1: SARA	
F1 Range1 F2 Range2 F3 Range3 F4 Range4 F5 Auto Range		Selected range: Range2: 300 ppm	
Actual range: Range1: 30.0 ppm	THC: 90.0	F1 Measurements	THC: 12.4
Thu Dec 30 01:20:32 2004		Thu Dec 30 01:20:32 2004	

Figure 7-20 Range 2 selection from Calibrations Menu

After selecting range two press **F1** to go to measurements or **F2** to go to calibrations.

Range select 1: SARA		Range select 3: SMAN	
F1 Range1 F2 Range2 F3 Range3 F4 Range4 F5 Auto Range		Selected range: Range3: 3000 ppm	
Actual range: Range1: 30.0 ppm	THC: 93.8	F1 Measurements	THC: 33.1
Thu Dec 30 01:20:32 2004		Thu Dec 30 01:20:32 2004	

Figure 7-21 Range 3 selection from Calibrations Menu

Range select 1: SARA		Range select 1: SARA	
F1 Range1		Selected range:	
F2 Range2		Range4: 30000 ppm	
F3 Range3			
F4 Range4			
F5 Auto Range			
Actual range:	THC: 93.8	F1 Measurements	THC: 26.1
Range1: 30.0 ppm		F2 Calibrations	
Thu Dec 30 01:20:32 2004		Thu Dec 30 01:20:32 2004	

Figure 7-22 Range 4 selection from Calibrations Menu

Range select 2: STBY		Range select 4: SHCG	
F1 Range1		Selected range:	
F2 Range2		Auto-R2: 300 ppm	
F3 Range3			
F4 Range4			
F5 Auto Range			
Actual range:	THC: 94.3	F1 Measurements	THC: 20.1
Range1: 30.0 ppm		F2 Calibrations	
Range Overflow		Thu Dec 30 01:20:32 2004	

Figure 7-23 Auto Range selection from Calibrations Menu

Press **F2** to return to the calibrations menu. (Pressing **F1** will return to the measurements screen.)

## 7.5. **F3** Display Deviations

The Display Deviations screen is used to view the calibration results.

Calibrations 3: SMAN		Display devs 1: SARA	
F1 Automatic calibration F2 Manual calibration » <b>F3 Display deviations »</b> F4 Check calibration F5 Reset calibration values » F6 Range select		<b>F1 Zero gas deviations</b> F2 Span gas deviations F3 Verifying devs. zero F4 Verifying devs. span	
Range1: 30.0 ppm			
Display absolute deviations	THC: 1.7	Display zero gas deviations	THC: 92.5
Thu Dec 30 01:20:32 2004		Thu Dec 30 01:20:32 2004	

Figure 7-24 **F3** Display deviations

### 7.5.1. Zero Gas Deviations

From the Main Menu press **F4** to select the Calibration Menu. Press **F3** to select Display deviations. Press **F1** to select Zero gas deviations which will display the change in percent of range for the zero gas relative to an ideal calibration curve (ABS) and the last calibration curve (REL).

Zero gas devs 5:		
Zero gas deviations [%]:		
	abs	rel
Range1:	-0.99	-0.67
Range2:	-0.12	-0.12
Range3:	0.00	0.00
Range4:	0.03	0.03
	THC: 92.5	
Mon Jan 31 15:30:28 2005		

Figure 7-25 Zero gas deviations



### 7.5.2. Span Gas Deviations.

From the Main Menu press **F4** to select the Calibration Menu. Press **F3** to select Display deviations. Press **F2** to select Span gas deviations which will display the change in percent of range for the span gas relative to an ideal calibration curve (ABS) and the last calibration curve (REL).

Span gas devs 1: SARA		
Span gas deviations [%]:		
	abs	rel
Range1:	93.17	93.17
Range2:	0.00	0.00
Range3:	0.00	0.00
Range4:	0.00	0.00
		THC: -392.5
Thu Dec_30 01:20:32 2004		

Figure 7-26 Span gas deviations

### 7.5.3. Verifying Deviations Zero.

From the Main Menu press **F4** to select the Calibration Menu. Press **F3** to select Display deviations. Press **F3** to select 'Verifying devs. Zero' which will display the value of the zero gas in PPM that will be reported by the analyzer when measured. The difference in percent from an ideal curve (ABS), and the difference in percent from the last calibration (REL) will also be displayed on the screen.

Zero gas devs 5:			
Zero gas devs. verifying			
	measured values	deviations	
		abs	rel
Range1:	0.0	0.00	0.00
Range2:	0.0	0.00	0.00
Range3:	0.0	0.00	0.00
Range4:	0.0	0.00	0.00
		THC: 392.5	
Thu Dec 30 01:20:32 2004			

Figure 7-27 Verifying Zero Gas Deviations

#### 7.5.4. Verifying Deviations Span.

From the Main Menu press **F4** to select the Calibration Menu. Press **F3** to select Display deviations. Press **F4** to select 'Verifying devs. span' which will display the value of the span gas in PPM that will be reported by the analyzer when measured. The difference in percent from an ideal curve (ABS) and the difference in percent from the last calibration (REL) will also be displayed

Span gas devs		3: SMAN		
Span gas devs. verifying				
	measured values	deviations		
		abs	rel	
Range1:	0.0	0.00	0.00	
Range2:	0.0	0.00	0.00	
Range3:	0.0	0.00	0.00	
Range4:	0.0	0.00	0.00	
			THC:	392.5
Thu Dec 30 01:20:32 2004				

Figure 7-28 Verifying Span Gas Deviations

## 7.6. **F5** Setup

From the Main Menu, **F5** brings up the setup menu. The Setup Menu used by operator to Input fixed information that will be stored for measuring, calibrating, and data transmission.

### 7.6.1. Entering the Span Gas Concentration.

From the Main Menu press **F5** for Setup. Press **F1** for Span Gas Concentration. (See Section 7.3.1)

Main Menu		4: SCH4	☰
F1	Measurements		
F2	Purge analyzer		
F3	Diagnostics		
F4	Calibrations	>>	
<b>F5</b>	<b>Setup</b>	>>	
F6	Remote/Manual		
F7	Standby		
F8	Ignition		
System settings		CH4: 1.6	
Thu Dec 30 01:20:32 2004			

Figure 7-29 Main menu (User level 4)

Setup		2: STBY	☰
<b>F1</b>	<b>Span gas concentrations</b>		
F2	Calibration settings	>>	
F3	Range limits	>>	
F4	Alarms	>>	
F5	Password	>>	
F6	Linearization	>>	
F7	System settings	>>	
↓ F8	Measure settings	>>	
Change span gas concentration		THC: 21.8	
Thu Dec 30 01:50:56 2004			

Figure 7-30 Setup menu 1

Setup		2: STBY	☰
<b>F1</b>	<b>Span gas concentrations</b>		
F2	Calibration settings	>>	
F3	Range limits	>>	
F4	Alarms	>>	
F5	Password	>>	
F6	Linearization	>>	
F7	System settings	>>	
↓ F8	Measure settings	>>	
Change span gas concentration		THC: 21.8	
Thu Dec 30 01:50:56 2004			

Figure 7-31 Span gas concentrations

Setup		1: SARE	☰
Span gas conc. range limits			
Range1:	27.000	30.00	
Range2:	270.000	3000.00	
Range3:	2700.000	30000.00	
Range4:	27000.000	300000.00	
		THC: 12.5	
Thu Dec 30 02:00:26 2004			

Figure 7-32 Change span gas settings

**Note: Entering more than one span gas concentration MANDATES a separate calibration for each range.**

**In the Automatic Calibration mode, entering a span gas concentration for only a single range will result in the span calibration of all ranges as based upon the theoretical range ratio of all other ranges with respect to the range for which the span gas concentration was entered.**

## 7.6.2. **F2** Calibration Settings

From the Setup Menu press **F2** for Calibration setting.

### 7.6.2.1 **F1** Times

There are four times, expressed in seconds, for auto calibration that can be changed. They are the Purge, Calibration, and Verifying times. (See Section 7.5.1.7)

Setup		1: SARE		Setup		1: SARE	
F1	Span gas concentrations			F1	Times		
F2	Calibration settings	»		F2	Measuring deviations		
F3	Range limits	»		F3	Deviations		
F4	Alarms	»		F4	Calib. via valves		
F5	Password	»		F5	Calib. via probe		
F6	Linearization	»					
F7	System settings	»					
F8	Measure settings	»					
Change times and tolerances		THC: 91.3		Change automatic calibration times		THC: 23.6	
Thu Dec 30 01:20:32 2004				Thu Dec 30 01:20:32 2004			

Figure 7-33 Change Auto Calibration Settings

Setup		1: SARE		Setup		4: SHCG	
F1	Times			Auto calibration times [sec]			
F2	Measuring deviations			Purge	:	10	
F3	Deviations			Measuring	:	9	
F4	Calib. via valves			Calibration	:	60	
F5	Calib. via probe			Verifying	:	10	
				Purge after	:	10	
Change automatic calibration times		THC: 23.6				THC: 88.5	
Thu Dec 30 01:20:32 2004				Thu Dec 30 01:20:32 2004			

Figure 7-34 Setup-times

### 7.6.2.2 **F2** Measuring Deviations.

Measuring Deviations are only used in the Automatic Calibration sequence to define acceptance limits during the “verifying” period.

Setup		4: SHCG		Setup		1: SARE	
F1	Times			Measuring deviation[%]			
F2	Measuring deviations			Range1:		1.00	
F3	Deviations			Range2:		1.00	
F4	Calib. via valves			Range3:		1.00	
F5	Calib. via probe			Range4:		1.00	
Change measuring deviations		THC: 12.5				THC: 95.5	
Thu Dec 30 01:20:32 2004				Thu Dec 30 01:20:32 2004			

Figure 7-35 Measuring deviations

7.6.2.3 **F3** Deviations

Deviations are used to define acceptable limits that must be met in order to generate and accept a new calibration curve. If any limit is exceeded the previous calibration will prevail. (See Section 7.5.1.9)

Setup	2: STBY	Setup	3: SMAN
F1 Times		Deviations[%]	
F2 Measuring deviations		absolute	relative
<b>F3 Deviations</b>		Range1:	10.00 10.00
F4 Calib. via valves		Range2:	10.00 10.00
F5 Calib. via probe		Range3:	10.00 10.00
		Range4:	10.00 10.00
Change deviations	THC: 87.8		THC: 20.7
Thu Dec 30 01:20:32 2004		Thu Dec 30 01:20:32 2004	

Figure 7-36 Absolute versus relative deviations

7.6.2.4 **F4** Calibrations via Valves/Probe

Calibrations can be made by using the optional built-in zero and span gas solenoids, or via the sample inlet port also known as via probe. (See Section 7.3.2)

**IMPORTANT:** If the analyzer contains an optional internal sample pump, the introduction of a pressurized sample gas in excess of 2.0 PSIG will damage the pump.

Setup	2: STBY	4: SHCG
F1 Times		Calibration via
F2 Measuring deviations		Solenoids
F3 Deviations		
<b>F4 Calib. via valves</b>		
F5 Calib. via probe		
Calib. gases	THC: 95.5	THC: 12.5
via solenoids		
Thu Dec 30 01:20:32 2004		Thu Dec 30 01:20:32 2004

Figure 7-37 Calibrations via internal solenoid valves

Setup	3: SMAN	4: SHCG
F1 Times		Calibration via
F2 Measuring deviations		Pump
F3 Deviations		
F4 Calib. via valves		
<b>F5 Calib. via probe</b>		
Calib. gases	THC: 95.4	THC: 88.1
flow via pump		
Thu Dec 30 01:20:32 2004		Thu Dec 30 01:20:32 2004

Figure 7-38 Calibration via probe

### 7.6.3. **F3** Range Limits

#### 7.6.3.1 Setting Full Scale Range Values

To set the Analyzer's full scale range values from the Setup Menu press **F3** for Range Limits. Press **F1** to select a setup sub-menu. Press **F1** again to select the Upper Range Limits Screen. These ranges were factory set per the customer's specifications. They can be re-defined in the field if necessary. Please contact the factory for further details.

Setup 1: SARE		Setup 3: SMAN	
F1	Span gas concentrations	F1	Range1-4
F2	Calibration settings	F2	Auto range
<b>F3</b>	<b>Range limits</b>		
F4	Alarms		
F5	Password		
F6	Linearization		
F7	System settings		
↓F8	Measure settings		
Change range limits		THC: 23.5	
Thu Dec 30 01:20:32 2004		Thu Dec 30 01:20:32 2004	

Figure 7-39 Change Range Limits

Setup 4: SHCG	
Upper range limits [ppm]	
Range1:	30.00
Range2:	300.00
Range3:	3000.00
Range4:	30000.00
THC: 20.5	
Thu Dec 30 01:20:32 2004	

Figure 7-40 Change Upper Range Limits

#### 7.6.3.2 Auto Range Switching Levels

This function is used to define the concentration values used for automatic range changing.

Setup 1: SARE		Setup 2: STBY	
F1	Range1-4	down up [ppm]	
<b>F2</b>	<b>Auto range</b>	Range1:	27
		Range2:	270
		Range3:	2700
		Range4:	2700
THC: 94.5		THC: 21.8	
Thu Dec 30 02:24:55 2004		Thu Dec 30 02:25:56 2004	

Figure 7-41 Change Auto Range Limits

### 7.6.4. Alarms

The analyzer provides several alarm messages and outputs to alert the operator to parameters that may require attention. The alarm set points are operator adjustable. .

Setup 1: SARE		Setup Alarms 1: SARE	
F1	Span gas concentrations	F1	T/C Alarms
F2	Calibration settings >>	F2	Pressure Alarms
F3	Range limits >>	F3	EPC Coil Alarms
F4	Alarms		
F5	Password >>		
F6	Linearization >>		
F7	System settings >>		
↓F8	Measure settings >>		
Enter and change passwords		Enter temperature and conc. alarms	
THC: 89.4		THC: 87.5	
Thu Dec 30 01:20:32 2004		Thu Dec 30 01:20:32 2004	

Figure 7-42 Setup Alarms

#### 7.6.4.1 [F1] Temperatures and Concentration Alarms (T/C Alarms)

This screen is used to identify and set the minimum and maximum alarm set points for the filter, burner, and pump temperatures, as well as for the measured concentrations.

Setup Alarms 1: SARE		T./C. Alarms 2: STBY	
F1	T/C Alarms	Temps: Filter:	Min 180.00 Max 200.00
F2	Pressure Alarms	[°C] Burner:	220.00 450.00
F3	EPC Coil Alarms	Oven:	180.00 200.00
		Cutter:	250.00 350.00
		Pump:	180.00 200.00
		Conc. alarm:	500.00 750.00
Enter temperature and conc. alarms		THC: 86.1	
THC: 87.5		Thu Dec 30 01:20:32 2004	
Thu Dec 30 01:20:32 2004		Thu Dec 30 01:20:32 2004	

Figure 7-43 Set Temperature Alarms

#### 7.6.4.2 [F2] Pressure Alarms

This screen is used to identify and set the minimum and maximum alarm set points for the sample, air, and fuel pressures.

Setup Alarms 1: SARE		Pressure Alarms 2: STBY	
F1	T/C Alarms	[PSIG]	Min Max
F2	Pressure Alarms	Sample:	1.50 2.50
F3	EPC Coil Alarms	Air:	2.00 10.00
		Fuel:	2.00 10.00
		Air Inject:	1.00 10.00
		Fuel Inject:	1.00 10.00
Enter pressure alarm parameters		THC: 21.9	
THC: 12.4		Thu Dec 30 01:20:32 2004	
Thu Dec 30 01:20:32 2004		Thu Dec 30 01:20:32 2004	

Figure 7-44 Select Set Pressure Alarms

### 7.6.4.3 **F3** EPC Coil Alarms

This screen is used to identify and set the minimum and maximum alarm set points for the coil voltages used to drive the Electronic Proportional Control (EPC) valves for the sample, air, and fuel.

Setup Alarms 2:STBY		EPC Coil Alarms 1:SARE	
F1 T/C Alarms		[U] Sample: Min	Max
F2 Pressure Alarms		Air: 2.00	00.00
<b>F3 EPC Coil Alarms</b>		Fuel: 2.00	00.00
		Air Inject: 2.00	00.00
		Fuel Inject: 2.00	00.00
Enter limits for EPC Coils	THC: 94.8		THC: 23.4
Thu Dec 30 01:20:32 2004		Thu Dec 30 01:20:32 2004	

Figure 7-45 Select Set EPC Coil Alarms

### 7.6.5. **F5** Password

Pressing **F5** will access another Menu referred to as the Password Setup Menu (See Section 5 for complete details).



### 7.6.6. **F6** Linearization

This mode will allow the operator to change the Linear Coefficients or view the Display Raw Value diagnostic screen.

#### 7.6.6.1 Change Linearization Coefficients

The operator can use this function to optimize linearity by inputting up to five coefficients for each range to generate up to a fourth order curve.

From the main Menu press **F5** for Setup. Press **F6** for Linearization. Press **F1** to select Change Lin. Coeffs. This will display a screen for selecting ranges.

Press **F1**, **F2**, **F3**, or **F4** to select the desired range. Next enter the desired coefficients. Be certain to press **F1** again to save the newly inputted data before exiting the screen.

Setup	3: SMAN	Linear-coefficients	1: SARE
F1 Span gas concentrations		F1 Change lin. coeffs.	
F2 Calibration settings		F2 Display rawvalue	
F3 Range limits			
F4 Alarms			
F5 Password			
F6 Linearization			
F7 System settings			
F8 Measure settings			
Change linear coefficients	THC: 17.6	Change linear coefficients	THC: 87.1
Thu Dec 30 01:20:32 2004		Thu Dec 30 01:20:32 2004	

Figure 7-46 Change Linearization Coefficients Screen

Setup	2: STBY	Setup	3: SMAN
Linear-coefficients		Linear-coefficients	
F1 Range1		a0: e+00	
F2 Range2		a1: e+00	
F3 Range3		a2: e+00	
F4 Range4		a3: e+00	
		a4: e+00	
	THC: 21.8		THC: 91.2
Thu Dec 30 01:20:32 2004		Thu Dec 30 01:20:32 2004	

Figure 7-47 Select Range/Linear Coefficients.

### 7.6.6.2 Display Raw Value

The operator can use this function to view three parameters:

- Lin Input: This is the ppm value of the measured sample using a perfect curve (as defined in Section 7.5.1.9) where 0 ppm is a raw voltage of exactly 1.00VDC, and 9.00VDC is precisely the full scale PPM value of the selected range.
- Measured Value: This is the ppm value of the measured sample using the most recent curve derived from the last zero and span calibration.
- Raw Value: This is a 1-9 VDC that will be digitized by the microprocessor to generate the calibration curve from which the Lin Input and Measured value derived.

Setup	4: SHCG	Measurements	1: SARE
Linear-coefficients		THC: 12.33	
F1 Change lin. coeffs. >>		Measured value	
F2 Display rawvalue		1.33	
		Raw Value	
		12.33	
		Lin.Input	
		F1: CH4/THC F3: Diag F7: Stby	
Display raw- and calculated values	THC: 85.9	Auto-R1: 30.0 ppm	THC: 12.3
Thu Dec 30 01:20:32 2004		Thu Dec 30 01:20:32 2004	

Figure 7-48 F2 Display Raw

### 7.6.7. F7 System Settings

This screen allows various system settings to be displayed and modified.

Setup	3: SMAN	System setup	2: STBY
F1 Span gas concentrations		F1 Realtime-Clock >>	
F2 Calibration settings >>		F2 TCP/IP settings	
F3 Range limits >>		F3 Output assignment	
F4 Alarms		F4 Output Range	
F5 Password >>		F5 status line on/off	
F6 Linearization >>		F7 Autostart	
F7 System settings >>			
↓F8 Measure settings >>		setup clock and	THC: 90.2
RTC, scheduler,	THC: 88.7	calib. scheduler	
TCP/IP			
Thu Dec 30 01:57:57 2004		Thu Dec 30 01:20:32 2004	

Figure 7-49 F7 System Setup Screen

## 7.6.7.1 Real Time Clock

Setup RTC		1: SARE	⏏
F1	Set time		
F2	Set autocalibration time		
F3	Select calibration range		
F4	Autocalibration on/off		
F10	Show time		
Set actual time		THC: 85.7	
Thu Dec 30 01:20:32 2004			

Figure 7-50 Setup RTC

Other Sections of this manual have described the **F1**, **F2**, **F3** and **F4** functions, as well as how to enable or disable the Automatic calibration sequence. (See Sections 7.5.1.1 though 7.5.1.4.)

From this sub-menu you may also view the next scheduled autocalibration time by pressing F10.

7.6.7.2 System Setup **F1** Real Time Clock

This function sets the analyzers internal clock (See Sections 7.5.1.1 through 7.5.1.4.)

Setup RTC		4: SHCG	⏏	schedule		2: STBY	⏏
F1	Set time			Starttime :	3: 0: 0 on Thu		
F2	Set autocalibration time			Date :	30. Dec 2004		
F3	Select calibration range			Every :	0		
F4	Autocalibration on/off			F1 -	change to weekly		
				F2 -	change to daily		
F10	Show time			F3 -	change to hourly		
Schedule auto. calibration		THC: 93.9		MAIN, BACK	exit	THC: 20.3	
				F1, F2, F3	save		
Thu Dec 30 01:20:32 2004				Thu Dec 30 01:20:32 2004			

Figure 7-51 Set Autocalibration Cal Timing

Setup RTC		1: SARE	⏏
F1	Set time		
F2	Set autocalibration time		
F3	Select calibration range		
F4	Autocalibration on/off		
F10	Show time		
enable/disable autocalibration		THC: 86.6	
Thu Dec 30 01:20:32 2004			

Figure 7-52 F4 Autocalibration status

### 7.6.7.3 **F2** TCP/IP Settings

TCP (Transmission Control Protocol) is a standard protocol for sending information between devices connected to a computer network and includes a format of packets, also called datagrams

IP (Internet Protocol) specifies the addressing scheme. Most networks combine IP with a higher-level protocol called Transmission Control Protocol (TCP), which establishes a virtual connection between a destination and a source.

Networks using the TCP/IP protocol route messages based on the IP address of the destination. The format of an IP address is a 32-bit numeric address written as four numbers separated by periods. Each number can be zero to 255. For example, 192.000.000.227 could be an IP address.

The IP address, Netmask, and Gateway when used are defined by the user. The Port and Winifport are assigned 7700 and 2000 by CAI and should not be changed unless required for a given location.

The HWaddress is assigned by CAI and cannot be changed.

To implement a change to this screen the appropriate fields must be changed then exit to the main menu. Turn off the power for two to three seconds and turn the power back on. The TCP/IP settings are saved and remain during subsequent power cycles.

**Note: This screen must be closed to retain changes before cycling power.**

System setup	1: SARE	TCPIP setup	2: STBY
F1 RealTime-Clock	>>	IP-address:	192.000.000.227
<b>F2 TCP/IP settings</b>		Netmask :	255.255.255.000
F3 Output assignment		Port :	0
F4 Output Range		Gateway :	000.000.000.000
F5 status line on/off		WinIfPort:	0
F7 Autostart		HWaddress :	00.E0.4B.06.8A.CB
set IP-address,	THC: 12.3	Reboot for new	THC: 20.4
netmask		settings	
Thu Dec 30 01:20:32 2004		Thu Dec 30 03:27:24 2004	

Figure 7-53 TCP/IP Address

### 7.6.7.4 **F3** Output Assignment

This function permits the operator to re-assign the output signals from those assigned at the factory to any signal from a pre-defined menu.

From the main Menu press **F5** for setup. Press **F7** for System settings. Press **F3** for Output Assignment. Press the Down **↓** or Up **↑** Arrow as required to select the existing output signal that is to be reassigned. Press the **Enter** key to access the alternate list of output signals.

Press the Down **↓** or Up **↑** Arrow as required until the desired signal is indicated.

**Consult the factor if required for more details**

### 7.6.7.5 **F4** Output Range

This screen determines the type of output signal. It is preset at the factory to be a voltage or current output and is scaled per the customer's order.

### 7.6.7.6 **F5** Status Line ON/OFF

The status line is the AK Protocol information (See Section 4.1.) that is displayed in the upper right-hand corner of the measurement screen. Pressing **F5** will toggle the status line.

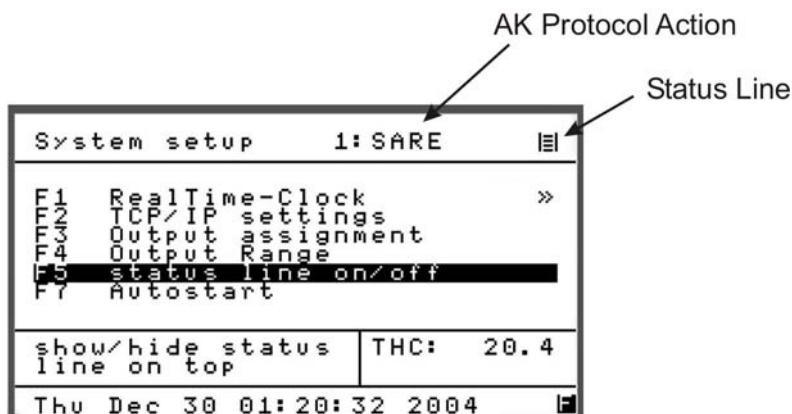

Figure 7-54 Status Line On/Off

### 7.6.7.7 **F7** Autostart

This menu determines the operating parameters of the autostart sequence.

- Auto Startup: Enables or disables the Autostart sequence.
- Wait for (Min): Sets the delay time before the start of the calibration sequence after power is re-stored and the microprocessor re-boots.
- Calibrations: The number of calibration cycles to be performed before the analyzer resumes measurement.
- Start Range: Determines the measuring range in which the analyzer will operate after the Calibrations complete.
- Ch4/THC Mode: These modes are not available on the 600HFID

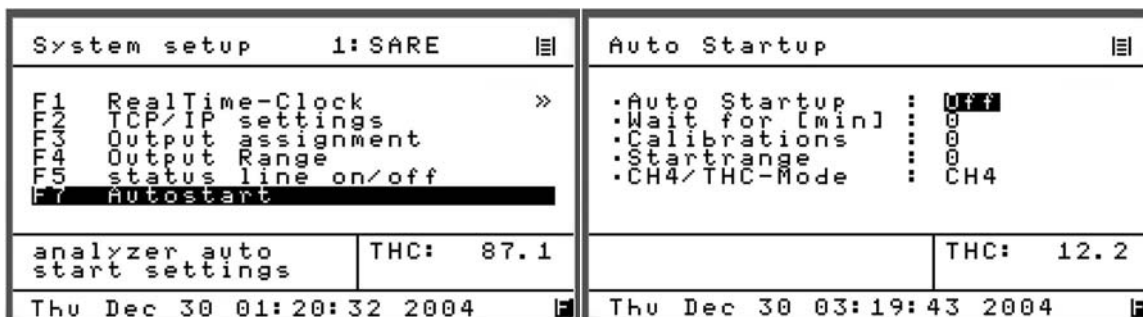

Figure 7-55 Autostart

### 7.6.8. **F8** Measure Settings

This menu permits several system settings to be displayed and modified. Functions **F1**, **F2**, **F3**, **F4**, and **F6** are not operational on the Model 600 HFID and are not discussed in this manual...

Setup		3: SMAN	≡
F1	Span gas concentrations		
F2	Calibration settings	>>	
F3	Range limits	>>	
F4	Alarms		
F5	Password	>>	
F6	Linearization	>>	
F7	System settings	>>	
↓F8	Measure settings	>>	
Lowpass filter and much more		THC: 17.2	
Thu Dec 30 01:20:32 2004			

**Figure 7-56 Menu Settings Screen**

Pressing **F3** will access the Lowpass Filter TC function. This allows the operator to change the analyzer's speed of response (aka time constant) to minimize noise. Entering a larger time constant will decrease the peak to peak noise while increasing the analyzers response time.

Measure setup		≡	Lowpass filter		≡
F1	Set dual-mode times		enter time constant of sample lowpass filter :		
F2	Cutter efficiency		Time constant (0..60): <input type="text" value="1"/>		
F3	Lowpass filter tc		used for calculating the sliding average.		
F4	Purge time				THC: 87.8
F6	T + P compensation				
enter sample lowpass filter		THC: 89.1			
Thu Dec 30 03:27:24 2004					

**Figure 7-57 Set Time Constant**

7.6.9. **F10** Version

From the Setup screen press **F10** to display the version of the software that is programmed in the microprocessor.

Setup		4: SHCG	≡
↑F2	Calibration settings	>>	
F3	Range limits	>>	
F4	Alarms	>>	
F5	Password	>>	
F6	Linearization	>>	
F7	System settings	>>	
F8	Measure settings	>>	
F10	Version	>>	
Show version information		THC: 88.6	
Thu Dec 30 01:20:32 2004			

Figure 7-58 Analyzer Information/Version

Version		≡	Version		≡
Model :	FID		FMAIN :	1.422	
S/N :	00-x-001		FUSER :	1.413	
Fuel pres.:	n/a		OSMSR :	0.000	
Air pres.:	n/a				
Sample pres.:	n/a				
Software version▶			◀Device info		
Thu Dec 30 01:20:32 2004			Fri Jan 28 10:28:35 2005		

Figure 7-59 Device/Software Version

### 7.6.10. **F6** Remote / Manual Control

Control of the analyzer can be accomplished by means of any of the following methods.

1. Manually, using the analyzers built-in keypad.
2. Remotely, via a computer through either the TCP/IP or RS232 interface.
3. Remotely, via discrete logic (or 'dry' relay contact closure) from a PLC or other logic control device.

The analyzer defaults to the Manual Mode of operation whenever AC power is restored to the analyzer. To select either the Manual Mode or the Remote Mode, go to the Main Menu. From the main Menu press F6. Each time F6 is pressed the analyzer will toggle between the Manual and Remote Mode of operation.

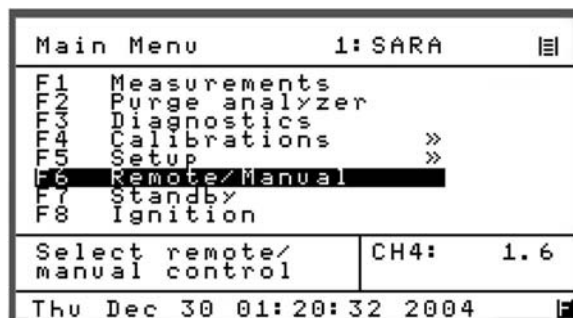

Figure 7-60 Remote manual control

### 7.6.11. **F7** Standby

In the Standby mode, the pump is turned off and the optional zero and span solenoids are closed, however the burner remains lit. The CAI logo is displayed.



Figure 7-61 Standby selection

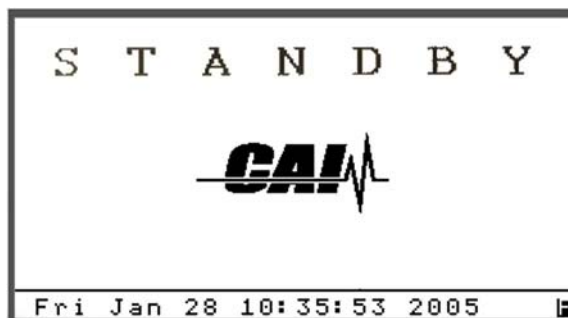

Figure 7-62 Standby screen



**7.6.12. F8 Ignition**

Press **F8** to ignite the analyzer flame for operation.

Main Menu		3: SMAN	☰
F1	Measurements		
F2	Purge analyzer		
F3	Diagnostics		
F4	Calibrations	»	
F5	Setup	»	
F6	Remote/Manual		
F7	Standby		
F8	Ignition		
Ignite analyzer		THC:	1.6
Thu Dec 30 01:20:32 2004			

Figure 7-63 Ignition

## 8. Functional Description

### 8.1. Operating Principle

The California Analytical Model 600 HFID Heated Total Hydrocarbon Analyzer uses the flame ionization detection-method of determination of total carbon (C) in a sample gas.

The detector is a burner that passed a regulated flow of sample gas through a flame sustained by a regulated flow of hydrocarbon free air and fuel gas 40% H<sub>2</sub>/60% He or 100% H<sub>2</sub>, as specified. The flame ionizes the hydrocarbon components of the sample producing negatively charged electrons and positively charged ions. A 300 volt (-300 VDC) polarized electrode collects these ions, causing a very low current to flow. A precision amplifier measures this low current. This current flow is directly proportional to the carbon content of the sample.

The instrument includes a temperature controlled sample oven. The oven maintains the sample at an elevated temperature. This temperature is factory set at 190 °C.

### 8.2. Burner Assembly

Unique regulated flow systems deliver the sample, burner air and fuel to the burner via capillaries and EPC valves. The sample and fuel are mixed together and then pass through the burner nozzle. Added air maintains the proper air/fuel mixture to sustain ignition. Energizing a standard glow plug accomplishes ignition. The burner has two electrodes, one is connected to the -300VDC power supply, and the other is connected to a precision amplifier. The small ionization current flowing between electrodes is directly proportional to the carbon atoms in the sample stream.

### 8.3. Flow System

The basic function of the sample, fuel, and air flow control systems is to deliver highly regulated flows of sample, fuel, and air to the burner assembly. The control of the fuel and air to the Burner Assembly is via precision, electronically controlled proportional pressure valve through precision capillaries. This control accurately pre-determines the flame characteristics. The supply cylinders should be set to 15-20 PSIG.

The sample flow to the burner is via another precision, electronically controlled proportional pressure valve through a precision capillary. This pressure is factory set at approximately 2 PSIG. A close-coupled by-pass capillary minimizes "dead volume" and improves response time. This by-pass flow is factory set by the capillary and flows approximately 3 liters/Min. Internal transducers monitor the sample fuel and air capillary pressures. The transducers in conjunction with EPC valves and temperature control result in precise flows of sample, fuel, and air.

#### 8.4. Sample Supply

A small inline 0.1 micron cartridge type filter is contained in the heated oven at the sample inlet; however an external heated sample filter is highly recommended for trouble-free operation.

***Note: It is mandatory that this External Filter Housing be heated to 190 °C to prevent any moisture (or Hydrocarbons) from condensing. All necessary precautions should be taken to prevent any 'Cold Spots' in the incoming sample line that would cause such condensation.***

An optional Heated Remote In-line Filter Assembly is available from CAI. If difficulty occurs with erratic sample flow, **TEMPORARILY** remove this filter when proceeding with diagnostic activity. It is necessary to replace contaminated filters.

The sample flow through the analyzer is controlled by a built-in adjustable electronic proportional pressure control valve. This pressure is factory set per the QA Check Sheet and may be monitored on the Diagnostics Screen at any time. The instrument has an optional internal sample pump that is capable of drawing a sample gas from an atmospheric sampling point a maximum distance of 85 feet through a ¼-inch O.D. heated sample line.

***Note: DO NOT apply an inlet pressure greater than 2 psig to Analyzers that have the 'Built -in Heated Sample Pump' option. Pressuring the inlet to the sample pump WILL DAMAGE THE PUMP. Analyzers that do not have the 'Built-in Heated Sample Pump' option require a nominal sample inlet pressure of 8-10 PSIG@3 LPM.***

## 9. Analyzer Components

### 9.1. Rear Panel

The following details the rear panel connections:

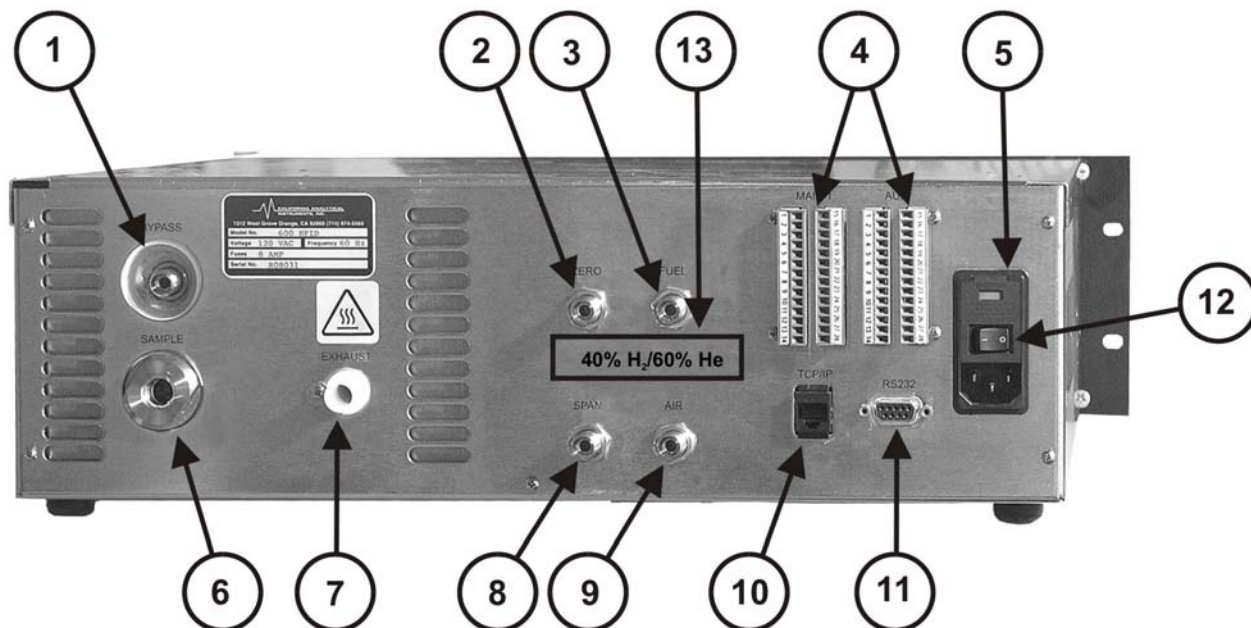

Figure 9-1 Rear Panel

1. **Sample Gas Bypass Outlet:** Exit for analyzer's bypass gas. (¼ Inch Tube)
2. **Zero Gas Inlet:** For feeding zero calibration gas to the analyzer. (Optional)
3. **Fuel Gas Inlet:** For feeding 40/60% H<sub>2</sub> He (or 100%H<sub>2</sub>) fuel to the burner for combustion.
4. **Output Connectors:** For analog outputs and discrete logic.
5. **Power Entry Module:** Power connection, power switch, fuse compartment (2 Amp).
6. **Sample Gas Inlet:** Feeds sample gas to the analyzer. (¼ Inch Tube)
7. **Vent:** Exhaust from FID Burner. (7/16-inch O.D. Teflon sleeve)
8. **Span Gas Inlet:** For feeding span calibration gas to the analyzer. (Optional)
9. **Air Inlet:** For feeding hydrocarbon free air to the analyzer for burner combustion.
10. **TCP/IP Port:** To Network Connector.
11. **Serial Port:** To Serial Connector.
12. **Rear Panel Power ON/OFF Switch:** Turns ON/OFF line power to instrument.
13. **Label:** For identifying the proper fuel to be used with each analyzer.

**Note:** Using a fuel type that is different from that which is specified by the label will result in a problem with operation of the analyzer and could cause severe damage to the analyzer (or surrounding equipment).

## 9.2. Internal Component Locations

### 9.2.1. Model 600 HFID Interior Layout

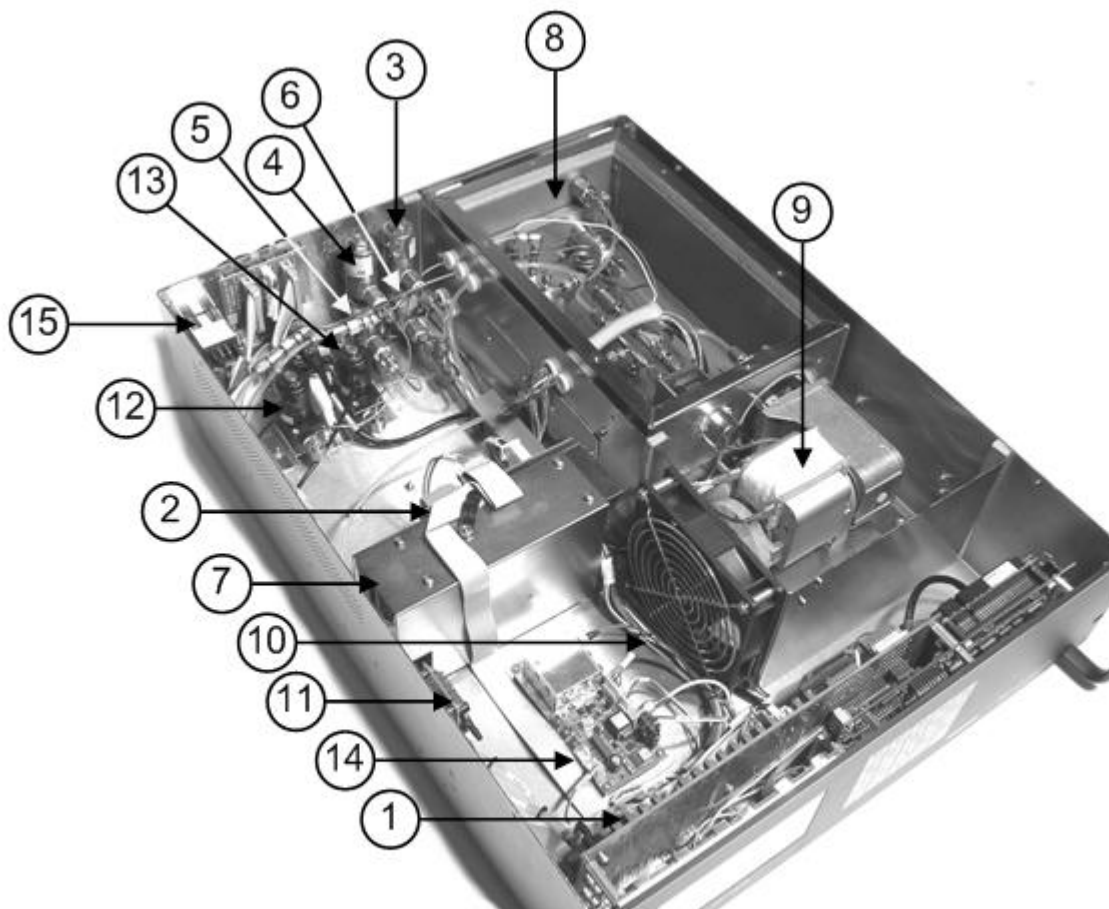
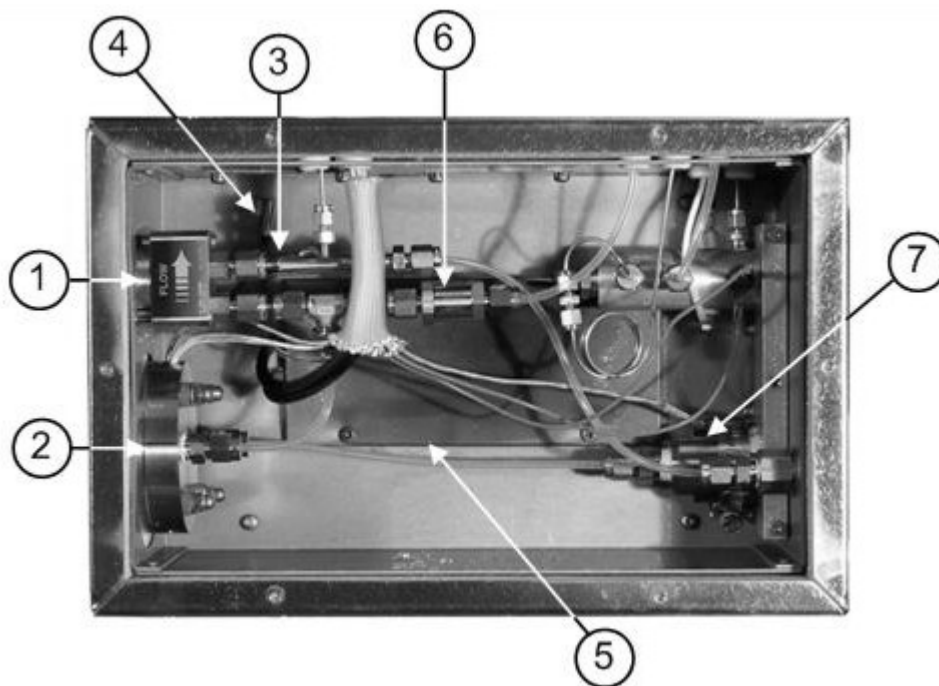

**Figure 9-2 Model 600 HFID Interior Layout**

1. **Electronics:** Includes signal processing PCB, Microprocessor PCB and LCD.
2. **Relay Control Board:** Provides AC voltage to heating elements and to optional pump.
3. **Zero Solenoid Valve:** Allows Zero Calibration Gas To Flow to Burner. (Optional)
4. **Fuel Solenoid Valve:** Automatic Fuel Shut Off.
5. **Air Solenoid Valve:** Automatic Air Shut Off.
6. **Span Solenoid Valve:** Allows Span Calibration Gas To Flow to Burner. (Optional)
7. **DC Power Supplies:**

8. **Heated Oven:** Maintains all sample handling components at a factory pre-set temperature of 190 °C. (See also Figure 9-3 for more detail)
9. **Heated Pump Assembly:** Draws in the sample gas for delivery to the burner. (Optional)
10. **Instrument Circulation Fan:** Provides internal air circulation.
11. **Fuel EPC Control Board:** Controls the fuel Proportional Control Valve.
12. **Fuel Proportional Control Valve:** Regulates the pressure of the fuel to a capillary.
13. **Air Proportional Control Valve:** Regulates the pressure of the combustion air.
14. **Signal PCB:** Amplifies the signal from the burner Assembly; provides the high voltage to the burner's collector and igniter power supply.
15. **Input Power Module:** Contains the 8 amp fuse and ON/OFF switch.

### 9.2.2. Oven Compartment Layout



**Figure 9-3 Model 600 HFID Oven Compartment (Full View)**

1. **Sample Proportional Control Valve:** Regulates the pressure of the sample gas to a capillary.
2. **Pump:** Head of Optional Sample Pump.
3. **EPC Manifold:** Distributes sample gas to a sample capillary, bypass capillary and sample pressure transducer.
4. **Oven Temperature Control RTD:** The sensing element used to control Oven temperatures.
5. **Heater Blanket:** Provides heat to the oven compartment.
6. **Check Valve:** Permits the flow of zero and span gases.
7. **Oven Temperature Monitor RTD:** Monitors the temperature of the oven at the sample gas inlet for display on the Diagnostic Screen.

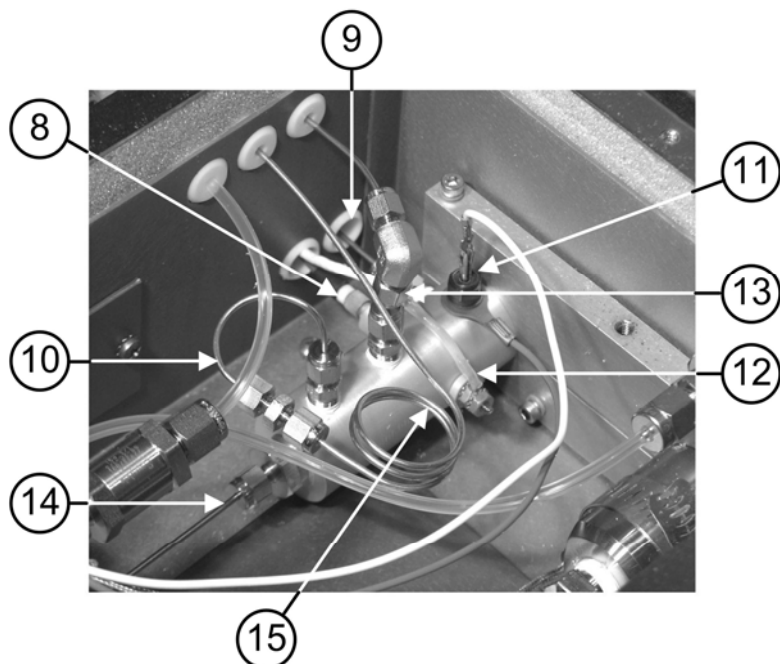

Figure 9-4 Oven Compartment (Close up)

8. **Signal Cable:** Carries the output signal from the burner to the signal PCB.
9. **Burner Thermocouple:** Monitors the temperature of the Burner (FID) flame.
10. **Air Capillary:** Limits the flow of combustion air to the burner.
11. **Igniter (Glow Plug):** Provides a source of ignition for the burner (FID).
12. **High Voltage Cable:** Supplies -300VDC to the burner.
13. **Fuel Capillary:** Limits the flow of fuel to the burner
14. **Sample Capillary:** In conjunction with the Sample Proportional Control Valve, this capillary controls the flow of the sample gas to the burner.
15. **Air Preheat Tube:** Preheats the combustion air before its introduction into the burner.



## 10. Operation

### 10.1. Startup

1. Check that the external plumbing and wiring are connected correctly, as described in Section III of this manual.
2. Power On: Turn ON the power switch on the rear panel. The LCD should partially illuminate then go completely dark for a couple of seconds before fully illuminating. During this time the microprocessor is booting up.

**Note: DO NOT attempt to ignite the burner or turn the optional sample pump on until the temperature of the oven reaches a minimum of 120 °C.**

3. Introduce Fuel and Burner Air: Adjust the cylinder output pressures to 20 PSIG. Upon initial installation, loosen the fuel inlet connection to allow the air to bleed from the fuel line. This should only take 5 to 10 seconds. Firmly re-connect the fuel line and test for leaks.
4. After the oven reaches a minimum of 180 °C go to the Main Menu press the **F8** key to initiate the automatic ignite sequence. The burner fuel and air pressures are controlled by Electronic Proportional Control Valves. When the ignition sequence is started **F8** an electronic igniter attempts to light the burner. The igniter cycles on and off until a factory set MINIMUM burner temperature of 220 °C is reached
5. Fuel and Air Pressure Settings:
  - a) Fuel and Air pressure pressures (and other operating parameters) can be monitored on the Diagnostics II screen.
  - b) Should agree with the factory set pressure settings indicated on the QA Checkout Sheet,  $\pm 1.0$  PSIG.

**Contact the factory immediately for assistance if these setting are not met.**

6. Flame Optimization: The fuel and air flow-rates are controlled using state-of-the-art pressure control and internal critical flow capillaries. This maintains flame optimization if the fuel and air pressures are within  $\pm 1.0$  PSIG of the respective settings, indicated above.
7. Zero Adjustment:
  - a) After the one-hour warm-up period, flow zero gas through the instrument sample or Zero inlet port.
  - b) Perform a zero calibration as outlined in Section 7.4.1.
8. Span Adjustment:
  - a) Flow span gas through the instrument sample or span inlet.
  - b) Perform a span calibration as outlined in Section 7.4.2. Sample Pressure Check:
    - c) While the span gas is still flowing, monitor the sample pressure on the Diagnostic II screen and verify that it is correct as recorded on the analyzers QA checkout sheet ( $\pm 0.2$  PSIG)

***Note: If the sample pressure is NOT in agreement with the QA checkout sheet confirm that a minimum of 8 PSIG is being supplied to analyzer's that DO NOT contain the optional built in sample pump. If your analyzer has a built in pump confirm that the pump is operating properly.***

## **10.2. Shutdown Procedure**

1. Turn off all gas supply cylinders.
2. Disconnect the sample line from the inlet port on the back of the analyzer.

***Do NOT turn off the pump or analyzer at this time.***

3. Allow the analyzer to draw in room air for approximately 5 minutes. This will flush out the analyzer of any remaining sample that may condense in the sample system.
4. Turn off the pump switch and THEN the analyzer.
5. Back-flush the EXTERNAL heated sample line (and filter) of any sample before disconnecting power.

## 11. Troubleshooting

### 11.1. Troubleshooting-Disassembly Procedures

#### 11.1.1. Oven Burner Assembly Filter Unit/Filter Removal

1. Shut off ALL gases. **CAUTION:** Burner may be hot if recently operational.
2. Remove power from the instrument.
3. Remove the sample line.
4. When the filter has cooled, use one wrench to hold the filter body and a second wrench to remove the filter holder assembly.
5. Remove and replace the filter. Re-install.

#### 11.1.2. Flow System/Fuel and Burner Air Supply.

Capillary protection micro-screen metal filters are contained in the respective solenoid output fittings. If difficulty occurs during the lighting sequence, **TEMPORARILY** remove these filters when proceeding with diagnostic activity. It is necessary to replace contaminated filters.

Fuel and Air flow rates are controlled by adjustable forward pressure devices that require 15-20 PSIG cylinder supply pressure and are factory set at the pressures indicated on the QA Check Sheet +/- 1.0 PSIG. These pressures may be monitored on the Diagnostics Display Screen during the ignite sequence or after the flame is ignited. The burner flow rate from the flow limiting capillaries is very low and will require a bubble flow meter to determine proper flow rates. If the pressures are properly set, whenever clogged lines are suspected replace the delivery lines containing the orifices.

***NOTE: Depending upon the amount of moisture contained in the sample gas, problems may develop in re-igniting the burner. If this should occur, perform the following procedure:***

1. Remove the Teflon sleeve from the burner exhaust on the rear panel.
2. Through a Teflon line, direct a flow of clean DRY gas into the burner exhaust port. A good source to use would be the instrument-burner air-supply. Reduce the pressure on this air supply and direct the clean air into the rear of the burner from a distance of approximately 2-4 inches. Let this air flow for approximately 1 minute. DO NOT insert this line directly into the burner.
3. With the Teflon sleeve still removed from the Burner's exhaust, restore all gas lines and attempt to light the burner.
4. If the burner will still not light, contact the factory.

## 11.2. Troubleshooting Guide

SYMPTOM	CAUSE	REMEDY
Downscale indication with flame out.	Electrical leakage in burner.	Check Burner voltage.
Burner will not ignite.	Air and/or Fuel Pressures improperly adjusted.  Improper operation of glow plug.	Depress Ignite button, and verify all pressures per manual and QA Data Sheet as viewed on the Diagnostic s Screen. <b>(IF OK)</b> <b>CAUTION: Turn OFF and bleed any pressure from the Combustion Air and fuel lines that are connected to the back of the analyzer BEFORE performing the following.</b> From the main Menu press <b>F8</b> and check for red glow from plug at burner vent. <b>(IF OK)</b> If plug glows, bleed off fuel line to instrument for 5 seconds. <b>(IF OK)</b> Check glow plug connections. <b>(IF OK)</b> Check for 1.1 VDC at plug connections. If OK, replace plug. <b>(IF OK)</b> Replace fuel and/or air capillaries.
Noisy Signal.	Sample pressure under regulator control limit of 6 PSIG. Water or contamination in burner.	Check and adjust as required. Change fuel and/or air supply. Replace external tubing. Check burner voltage.
Loss of Sensitivity. (Not enough gain)	Contamination in fuel/air or sample flow system.	Verify air and fuel pressures to be set per calibration sheet. <b>(IF OK)</b> Verify sample pressure to be set per calibration sheet. <b>(IF OK)</b> Verify by-pass flow to be at 3 Liters/Min. $\pm$ 1.5. <b>(IF OK)</b> Verify 200 volt DC collector voltage. ( $\pm$ 15 Volts) <b>(IF OK)</b> Carefully remove burner signal co-ax cable. Touch center conductor and watch for up scale reading. <b>(IF OK)</b> Remove and clean sample critical orifice. <b>(IF OK)</b> Check Co-Ax cable for continuity.

### 11.3. Error Messages

<u>Message No</u>	<u>Error Message</u>	<u>Indicating Device</u>
1	No flame	Burner RTD
2	Air pressure failure	Air pressure transducer
3	Fuel pressure failure	Fuel pressure transducer
4	Air inject pressure failure	Air inject EPC transducer
5	Fuel inject pressure failure	Fuel inject EPC transducer
6	Filter temp failure	Filter RTD
7	Burner temp failure	Burner RTD
8	Oven temp failure	Oven RTD
9	EPC coil fuel failure	Fuel EPC coil voltage
10	EPC coil air failure	Air EPC coil voltage
11	EPC coil sample failure	Sample EPC coil voltage
12	Sample pressure failure	Sample pressure transducer
13	ADC range under flow	ADC (input voltage $\leq 0.0$ V )
14	ADC range overflow	ADC (input voltage $\geq 10.0$ V
15	Range under flow	ADC (input voltage $\leq 1.0$ V )
16	Range over flow	ADC (input voltage $\geq 9.0$ V
17	Low concentration warning	Operator defined value
18	High concentration warning	Operator defined value
19	Calibration error	Calibration exceeded operator defined deviation

## 12. AK Protocol Format

The master computer and the Model 600 HFID analyzer communicate via the RS232 serial link. The Model 600 HFID analyzer acts as a "slave" and only responds to commands.

Serial Interface Parameters:

1. Baud from 300 to 9600 bps, can be selected via the display.
2. 7 or 8 data bits, 1 or 2 stop bits, and the parity (yes/no).
3. The data transmission is full duplex (no echo) with XON/XOFF protocol.
4. The "don't-care" byte" (byte 2) is adjustable (factory setting 20H).

Command Format:	
<STX>	02H Example: ASTZ K0
don't care	any byte (default 20H)
function code	code 4 byte long (e.g., ASTZ)
space 20H	20H
channel N° always "K0" for the analyzer	
space	20H (only if followed by data, otherwise <ETX> )
data	data bytes (depending on the command)
<ETX>	03H
Answer Format:	
<STX>	02H Example: STZ 0 SREM STBY
don't care	adjustable, factory setting 20H
function code	same code as command package (e.g., ASTZ)
space	20H
status	0 without error or 1 to 9 when error (see also ASTF command)
space	20H (only if followed by data, otherwise <ETX> )
data	parameter (depending on the command)
<ETX>	03H

### 12.1. Serial Interface and AK-Commands

The serial interface enables remote control of the Model 600 HFID analyzer by a master computer. It is implemented as an RS232 V24 interface and meets all requirements of the AK protocol.

A 9-pin male connector at the back of the unit is used to connect a master computer with the following pin assignment:

Pin 3 = Txd (transmit)

Pin 2 = Rxd (receive)

Pin 5 = Gnd (ground)

### 12.2. Interface Parameters

Baud rate:	9600, 4800, 2400, 1200, 600, 300 baud
Data bits:	7 or 8
Stop bit:	1 or 2
Don't care:	1 byte, adjustable (e.g. 32)
Parity:	Even, odd, none
XON/XOFF:	Active or not active

### 12.3. General AK Requirements

1. If the command message contains no error, the acknowledge message contains the echo of the function code and the error status number (1 to 9).
2. If the transfer was faulty or the function code unknown, the answer contains four question marks (example. "???? 0").
3. If the displayed value is not valid, a "#" is placed in front of the measured value (example: "AIKG 0 #9999").
4. If a control or adjusting command is sent via the serial interface while the measuring device is in "Manual" mode, it sends an answer like "SLIN 0 K0 OF".
5. If a channel does not exist, the answer for control and adjusting commands is e.g. "ATEM 0 3 NA" in which 3 is the number of the sub-channel.
6. If the device is busy with a running function (SLIN, for example), every arriving control command is ignored (except SRES and STBY); and the response message is e.g. "SMAN 0 BS. If In the mode "SINT" an additional "SINT KO" command is received, the integrator is reset to 0 and the integration is restarted.
7. If the command message contains data that the measuring device cannot process ("ESYZ K0 ABC", for example,) the response message is "ESYZ 0 SE". A syntax error is recognized if the data does not match the expected format or if the parameters do not fit the expected size.
8. Numbers are in floating-point format with decimal point. The decimal point can be dropped for integers.
9. If you switch from "Manual" to "Remote" at the device, it remains in "Manual" mode until a "SREM K0" is received by the control computer. On the display, this mode is indicated by REME" (Remote enable) on the status line. In manual mode, query commands via the serial interface are possible at any time.

### 12.4. Scans

#### 12.4.1. AKON: Measured concentration value

Command	Response	Description
_AKON_K0	_AKON_s_z.z_y.y_x.x_w.w	Measured concentration value is responded z.z : current measured value y.y : NO x.x : NO2 w.w : NOx y.y, x.x, w.w are only used in Dual measure mode. Otherwise "0.0" will be returned

#### 12.4.2. AEMB: Set measuring range

Command	Response	Description
_AEMB_K0	_AEMB_s_Mn	Current measuring range is responded

#### 12.4.3. AMBE: Measuring range limit

Command	Response	Description
---------	----------	-------------

_AMBE_K0	_AMBE_s_M1_w.w_M2_x.x_M3_y.y_M4_z.z	All existing measuring range limits are responded
_AMBE_K0_Mn	_AMBE_s_Mn_z.z	Range limit of Range Mn is responded

#### 12.4.4. AKAK: Calibration gas concentrations

Command	Response	Description
AKAK_K0	_AKAK_s_M1_w.w_M2_x.x_M3_y.y_M4_z.z	All existing calibration gas values are responded
AKAK_K0_Mn	AKAK_s_Mn_z.z	Calibration gas value of Range Mn is responded

#### 12.4.5. AMBU: Upper and lower range switchover values for auto range

Command	Response	Description
_AMBU_K0	_AMBU_s_M1_w.w_W.W_M2_x.x_X.X_M3_y.y_Y.Y_M4_z.z_Z.Z	Lower and upper range switchover value of auto range are responded

#### 12.4.6. ASTZ: Normal device status

Command	Response	Description
_ASTZ_K0	_ASTZ_s_SREM_STBY__SENO_SARE_SDRY	Device status is responded

##### 12.4.6.1 Possible states:

SREM: remote	STBY: standby	SHCG: Cutter off	SARE: Autorange on	SDRY: Chiller on
SMAN: manual	SPAU: pause	SMAN: Cutter active	SARA: Autorange off	SWET: Chiller off
	SMGA: measuring gas			
	SNGA: zero gas			
	SEGA: end gas			
	SATK SNGA: zero gas during autocal			
	SATK SEGA: end gas during autocal			
	SLIN: For compatibility only			
	SSPL: purging			
	SKOP: measure			



**12.4.7. ASTF: Error status**

Command	Response	Description
_ASTF_K0	_ASTF_s_f1_f2_f3._f15	Current error number is responded

**Errors:**

1	No Flame	9	EPC Coil Sample Failure
2	Sample Pressure Failure	10	EPC Coil Air Failure
3	Air Pressure Failure	11	EPC Coil Fuel Failure
4	Fuel Pressure	12	Range Overflow
5	Burner Temp Failure	13	ADC Range Overflow
6	Oven Temp Failure	14	ADC Range Underflow
7	Cutter Temp Failure	15	Analyzer is not calibrated
8	Pump Temp Failure		

**12.4.8. AKEN: Device identification**

Command	Response	Description
_AKEN_K0	_AKEN_s_devicename	Device identification is responded

**12.4.9. ARMU: Raw value**

Command	Response	Description
_ARMU_K0	_ARMU_s_z.z	Raw value before linearization and offset-span-correction is responded

**12.4.10. ATEM: Temperatures**

Command	Response	Description
_ATEM_K0	_ATEM_s_z.z_y.y_...	All Temperatures in degrees Celsius are responded
_ATEM_K0_x	_ATEM_s_z.z	Temperature of x in degrees Celsius is responded

**Description of x:**

X	FID
1	Burner Temp
2	Oven Temp
3	Cutter Temp
4	Pump Temp

**12.4.11. ADRU: Pressures**

Command	Response	Description
_ADRU_K0	_ADRU_s_z.z_y.y_...	All pressures are responded
_ADRU_K0_x	_ADRU_s_z.z	Pressure of x is responded

**Description of x:**

1	Sample Pressure
2	Air Pressure
3	Fuel Pressure
4	Sample EPC Coil Voltage
5	Air EPC Coil Voltage
6	Fuel EPC Voltage

**12.4.12. ADUF: Flows**

Command	Response	Description
_ADUF_K0	_ADRU_s_z.z_y.y_...	All flows are responded
_ADUF_K0_x	_ADRU_s_z.z	Flow of x is responded

**Description of x:**

1	Sample Flow
2	Air Flow
3	Fuel Flow

**12.4.13. AGRD: Polynom coefficients**

Command	Response	Description
_AGRD_K0_Mn	_AGRD_s_Mn_a0_a1_a2_a3_a4	Polynom coefficients of range Mn are responded

**12.4.14. AANG: Deviation from zero point after autocalibration**

Command	Response	Description
_AANG_K0	_AANG_s_M1_z.z_da_dr_ M2_z.z_da_dr_ M3_z.z_da_dr_ M4_z.z_da_dr_	Deviation from zero point after autocalibration

**12.4.15. AAEG: Deviation from end point after autocalibration**

Command	Response	Description
_AAEG_K0	_AANG_s_M1_z.z_da_dr_ M2_z.z_da_dr_ M3_z.z_da_dr_ M4_z.z_da_dr_	Deviation from end point after autocalibration

**12.4.16. AFDA: Purge and Autocalibration times**

Command	Response	Description
_AFDA_K0_SATK	_AFDA_s_z_y_x_w_Z.Z	Autocalibration times: z: Purge time y: Calibration time x: Total Calibration time w: Verify time (z,y,x,w in seconds)
_AFDAKO_SSPL	AFDA_s_z.z	Purge time will be responded

**12.4.17. APAR: Request Autocalibration tolerance values**

Command	Response	Description
_APAR_K0_SATK	_APAR_s_z.z_y.y_x.x_w.w	Autocalibration tolerance value (%): z.z: Range 1 y.y: Range 2 x.x: Range 3 w.w: Range 4

**12.4.18. AKAL: Deviations from calibration**

Command	Response	Description
_AKAL_K0_	_AKAL_s_M1_z.z_y.y_x.x_w.w _AKAL_s_M2_z.z_y.y_x.x_w.w _AKAL_s_M3_z.z_y.y_x.x_w.w _AKAL_s_M4_z.z_y.y_x.x_w.w	Deviation (ppm): z.z: Zero gas relative to last calibration y.y: Zero gas factory calibration x.x: Span gas relative to last calibration w.w: Span gas factory calibration

**12.4.19. ASYZ: Respond System Time**

Command	Response	Description
_ASYZ_K0_	_ASYZ_s_yymmdd_hhmmss	Respond system time yymmdd:year, month, day (each 2 characters wide, no spaces) hhmmss:hour, minutes, seconds)

**12.4.20. AT90: Respond Lowpass filter time**

Command	Response	Description
_AT90_K0_	_AT90_s_t	Respond lowpass filter time t=filter time in seconds

**12.4.21. ADAL: Diagnostic alarm limits**

Command	Response	Description
_ADAL_K0	_ADAL_s_a1.min_a1.max_.f12.max	All alarms are responded
_ADAL_K0_x	_ADAL_s_x.min_x.max	Alarm limits of x

**Alarm Limits:**

1	Not used	7	Cutter Temperature
2	Sample Pressure	8	Pump Temperature
3	Air Pressure	9	Sample EPC Coil Voltage
4	Fuel Pressure	10	Air EPC Coil Voltage
5	Burner Temperature	11	Fuel EPC Coil Voltage
6	Oven Temperature	12	Sample Content

**12.4.22. ACXB: Respond Display Factor**

Command	Response	Description
_ACXB_K0	_ACXB_s_1 _ACXB_s_3.	C1 – Display C3 – Display

## 12.5. Control commands

### 12.5.1. SRES: Reset

Command	Response	Description
_SRES_K0	_SRES_s	Reset

### 12.5.2. SPAU: Pause

Command	Response	Description
_SPAU_K0	_SPAU_s	Pause mode

### 12.5.3. STBY: Standby

Command	Response	Description
_STBY_K0	_STBY_s	Standby mode

### 12.5.4. SNGA: Open valve for zero gas calibration

Command	Response	Description
_SNGA_K0	_SNGA_s	Open valve for zero gas calibration of actual measuring range
_SNGA_K0_Mn	_SNGA_s	Open valve for zero gas calibration of range Mn

### 12.5.5. SEGA: Open valve for end gas calibration

Command	Response	Description
_SEGA_K0	_SEGA_s	Open valve for end gas calibration of actual measuring range
_SEGA_K0_Mn	_SEGA_s	Open valve for end gas calibration of range Mn

### 12.5.6. SSPL: Purge Analyzer with zero gas

Command	Response	Description
_SSPL_K0	_SSPL_s	Open valve for zero gas and purge the analyzer

### 12.5.7. SLIN: Linearization mode

Command	Response	Description
_SLIN_K0	_SLIN_s	Change status to SLIN (only for compatibility)

### 12.5.8. SATK: Start automatic calibration

Command	Response	Description
_SATK_K0	_SATK_	Start automatic calibration of all ranges
_SATK_K0_Mn	_SATK_s	Start automatic calibration using range Mn

### 12.5.9. SEMB: Set measuring range

Command	Response	Description
_SEMB_K0_Mn	_SEMB_s	Set measuring range Autorange is disabled

**12.5.10. SARE: Auto range on**

Command	Response	Description
SARE_K0	SARE_s	Set auto range on

**12.5.11. SARA: Auto range off**

Command	Response	Description
_SARA_K0	_SARA_s	Set auto range off

**12.5.12. SREM: Remote mode for AK-commands**

Command	Response	Description
_SREM_K0	_SREM_s	Set device in remote mode

**12.5.13. SMAN: Manual control to control device manually**

Command	Response	Description
_SMAN_K0	_SMAN_s	Set device in manual mode

**12.5.14. SMGA: Start measuring**

Command	Response	Description
_SMGA_K0	_SMGA_s	Start measuring Turn on pump for sample gas

**12.5.15. SNKA: Saves measured value as new offset.**

Command	Response	Description
_SNKA_K0	_SNKA_s	Saves measured value of actual range as new offset if zero valve is opened

**12.5.16. SEKA: Saves measured value as new span value**

Command	Response	Description
_SEKA_K0	_SEKA_s	Saves measured value of actual range as new span value if span valve is opened

**12.5.17. SHCG: Cutter off**

Command	Response	Description
_SENO_K0	_SENO_s	Set cutter off THC is measured

**12.5.18. SCH4: Cutter on**

Command	Response	Description
_SNOX_K0	_SNOX_s	Set cutter on Crack HC's to C1 (methane)

**12.5.19. S---: Enable dual measure mode**

Command	Response	Description
_S---_K0	_S---_s	Activates dual measure mode. Analyzer switches periodically between CH4 and THC mode and displays CH4 NMHC, THC

## 12.6. Settings

### 12.6.1. EKAK: The four span gas concentration values are set

Command	Response	Description
_EKAK_K0_M1_w.w_M2_x.x_M3_y.y_M4_z.z	_EKAK_s	Set end gas values

### 12.6.2. EMBE: The four measuring range end values are set

Command	Response	Description
_EMBE_K0_M1_w.w_M2_x.x_M3_y.y_M4_z.z	_EMBE_s	Set range limits

### 12.6.3. EMBU: The upper and the lower range switchover for autorange are set

Command	Response	Description
_EMBU_K0_M1_w.w_W.W_M2_x.x_X.X_M3_y.y_Y.Y_M4_z.z_Z.Z	_EMBU_s	Set lower and upper range switchover limits

### 12.6.4. EKEN: Set new device identification

Command	Response	Description
_EKEN_K0_new device-name	_EKEN_s	Set new device identification Maximum length of device name are 40 characters

**NOTE:** To change device identification, you must first rename the device to "RESET." Now a name up to 40 letters can be given.

**NOTE:** The device name must not have any blanks between, i.e. "CAI CLD" is not allowed. You can use underlines, i.e. "CAI\_CLD."

### 12.6.5. EGRD: Set polynom coefficients

Command	Response	Description
_EGRD_K0_Mn_a0_a1_a2_a3_a4	_EGRD_s	Set polynom coefficients of range Mn

### 12.6.6. EFDA: Set autocalibration and purge times

Command	Response	Description
_EFDA_K0_SATK_z_y_x_w	_EFDA_s	Set autocalibration times: z= Purge time y=Calibration time x=Total calibration time w=Verify time (z,y,x,w in seconds)
_EFDA_K0_SSPL_z	_EFDA_s	Set analyzer purge time to z seconds

### 12.6.7. EPAR: Set autocalibration tolerance values

Command	Response	Description
_EPAR_K0_SATK_z.z_y.y_x.x_w.w	_EPAR_s	Autocalibration Tolerance value (%): z.z= Range 1 y.y= Range 2

x.x= Range 3  
w.w= Range 4

### 12.6.8. ESYZ: Set System Time

Command	Response	Description
_ESYZ_K0_yymmdd_hhmmss	_ESYA_s	Respond system time: yymmdd:year, month, day (each 2 characters wide, no spaces) hhmmss: hour, minutes, seconds)

### 12.6.9. ET90: Set Lowpass Filter Time

Command	Response	Description
_ET90_K0_t	_ET90_s	Set lowpass filter time: t= filter time in seconds

### 12.6.10. EDAL: Diagnostic alarm limits

Command	Response	Description
_EDAL_K0_a1.min_a1.mas_..._a12max	_EDAL_s	Set all alarm limits
_EDAL_K0_x_x.min_xmax	_EDAL_s	Set alarm limits of x

#### Alarm Limits:

1	Not used	7	Cutter Temperature
2	Sample Pressure	8	Pump Temperature
3	Air Pressure	9	Sample EPC Coil Voltage
4	Fuel Pressure	10	Air EPC Coil Voltage
5	Burner Temperature	11	Fuel EPC Coil Voltage
6	Oven Temperature	12	Sample Content

### 12.6.11. ECXB: Set Display Factor

Command	Response	Description
_ECXB_K0_	_ECXB_s	Set to C1 (methane)
_ECXB_K0_3	_ECXB_s	Set to C3 (propane)

## 12.7. Abbreviations used

Mn	: Measuring range number
M1 .. M4	: Measuring Range 1 .. 4
w.w .. Z.Z.	: Numerical value
t	: Numeric integer value
x	: Number
yyymmdd	:Date of format year, month and day with 2 characters each and no spaces
hhmmss	:Time of format hour, minute and second with 2 characters each and no spaces
a0 .. a4	: Polynom coefficients
s	: Status

## 13. Appendix

### 13.1. Connectors

#### 13.1.1.

**Note: Analog outputs equal 0-10VDC maximum and Digital outputs 0-5VDC (TTL Levels). Analog inputs 0-10VDC Maximum. DO NOT EXCEED 10VDC on the Analog inputs or damage to the analyzer may occur.**

#### Main Connector (Standard 28 Pin Connector)

Pin	Signal	Function	Pin	Signal	Function
1	Analog Output	Ground (Analog)	15	Digital Input	Control Range 3
2	Analog Output	Real Time 0-10VDC Max	16	Digital Input	Control Range 4
3	Analog Output	Real Time 0-10VDC Max	17	Digital Input	Auto Cal
4	Analog Output	Real Time 0-10VDC Max	18	Digital Input	Calibrate
5	Analog Output	Real Time 0-10VDC Max	19	Digital Input	Zero
6	Digital Output	Ground (Digital)	20	Digital Input	Span
7	Digital Output	Sense Auto Range	21	Digital Input	Pump
8	Digital Output	Sense Range 1	22	Digital Output	Zero Gas Flow
9	Digital Output	Sense Range 2	23	Digital Output	Span Gas Flow
10	Digital Output	Sense Range 3	24	Digital Output	Sample Gas Flow
11	Digital Output	Sense Range 4	25	Digital Output	Local/Remote
12	Digital Input	Set Auto Range	26	Digital Output	Read Cal Mode
13	Digital Input	Control Range 1	27	Digital Output	Reserved
14	Digital Input	Control Range 2	28	Digital Output	Reserved

#### 13.1.2. Auxiliary Connector (Standard 28 Pin Connector)

Pin	Signal	Function	Pin	Signal	Function
1	Analog Input	Ground	15	Digital Output	Ground (Alarm)
2	Analog Input	External Analog 1	16	Digital Output	Calibrate Alarm 1
3	Analog Input	External Analog 2	17	Digital Output	Reserved
4	Analog Input	Spare Analog	18	Digital Output	Reserved
5	Analog Input	Spare Analog	19	Digital Output	Reserved
6	Digital Output	Ground (Alarm)	20	Digital Output	Read Flame On
7	Digital Output	General Alarm	21	Digital Output	Read Overflow
8	Digital Output	Ch 1 Conc Alarm	22	Digital Output	Read the Mode
9	Digital Output	Ch 2 Conc Alarm	23	Digital Input	Start Ignition
10	Digital Output	Reserved	24	Digital Input	Set Overflow Mode
11	Digital Output	Reserved	25	Digital Input	Set the Mode
12	Digital Input	Reserved	26	DI/DO	spare
13	Digital Input	Reserved	27	DI/DO	Spare
14	Digital Input	Reserved	28	DI/DO	Spare



**13.1.3. Digital Outputs – RS-232 (Standard 9 Pin DIN Connector)**

Pin	Function
1	DCD Carrier Detect
2	RxD Receive Data
3	TxD Transmit Data
4	DTR Data Terminal Ready
5	Ground
6	DSR Data Set Ready
7	RTS Ready to Send
8	CTS Clear to Send
9	RI Ring Indicator

**13.1.4. Digital Outputs – TCP/IP (8 Pin RJ-47 Connector)**

Pin	Function
1	TDX+
2	TDX-
3	RXD+
4	Open
5	Open
6	RXD-
7	LNLED
8	LNLED

***IMPORTANT TIP: For direct connect to a PC a crossover cable is required. Connection to a hub requires a straight cable.***

13.2. Model 600 HFID Flow Diagrams

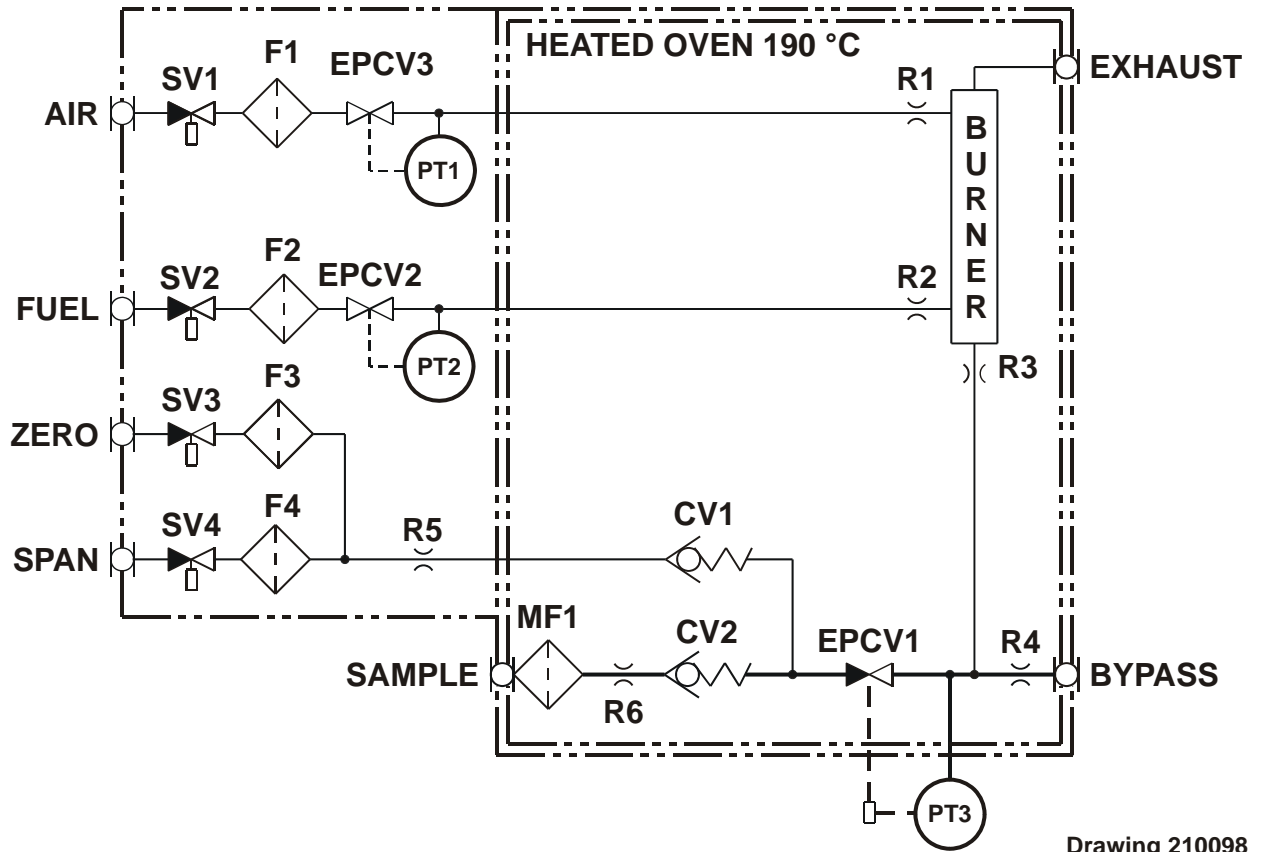

Drawing 210098

Figure 13-1: 600 HFID Standard Analyzer/Without Pump

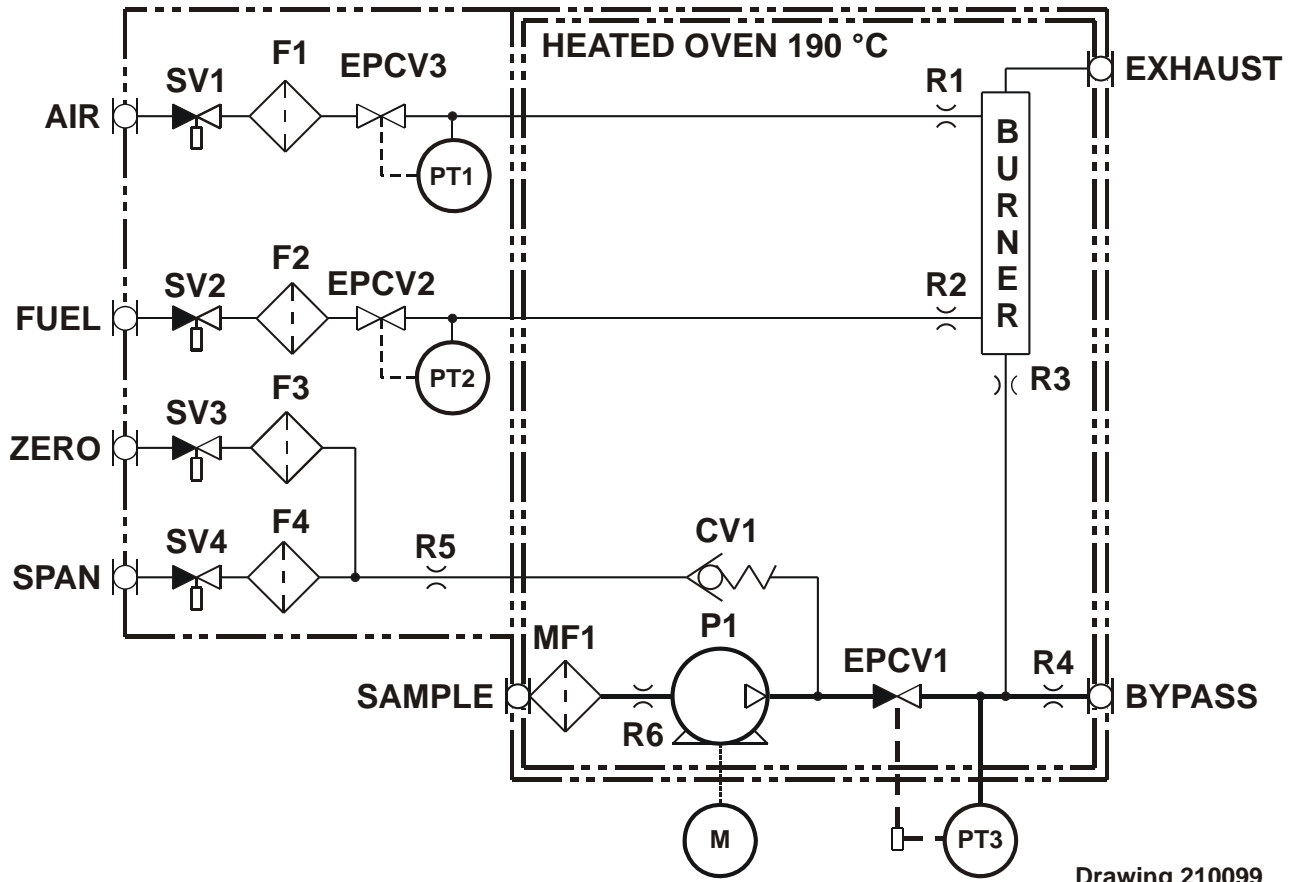

Drawing 210099

Figure 13-2: 600 HFID Standard Analyzer with Pump

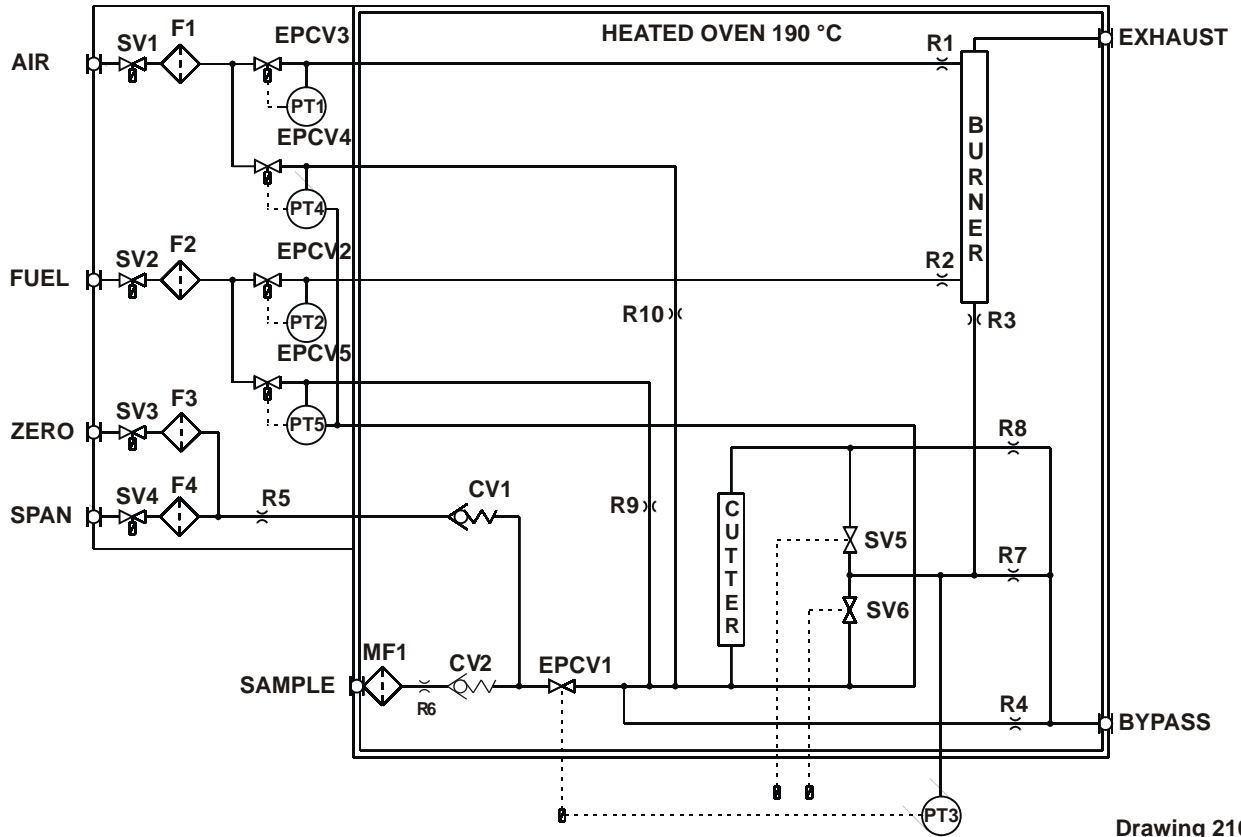

Drawing 210103

Figure 13-3: 600M-HFID with Non-Methane Cutter Assembly without Pump

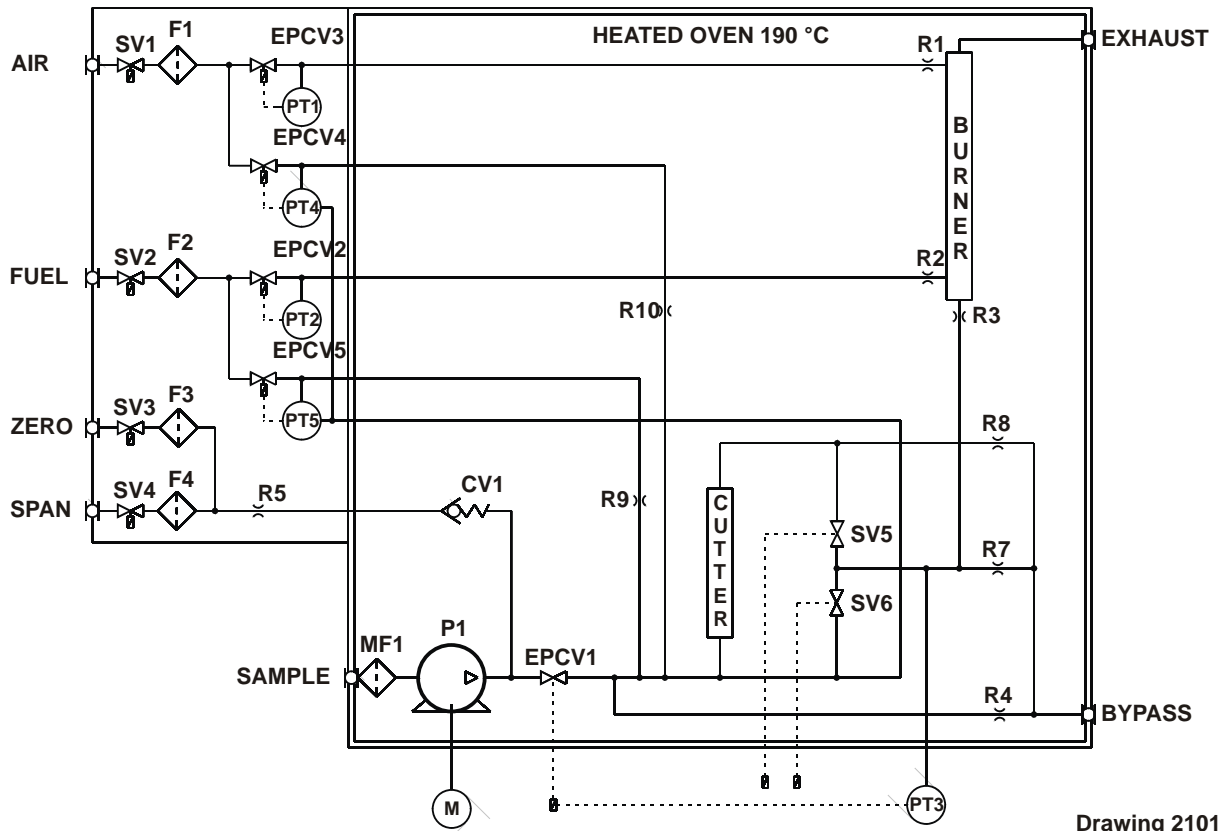

Drawing 210104

Figure 13-4: 600M-HFID with Non-Methane Cutter Assembly with Pump



13.4. AC Power 600 HCLD/HFID

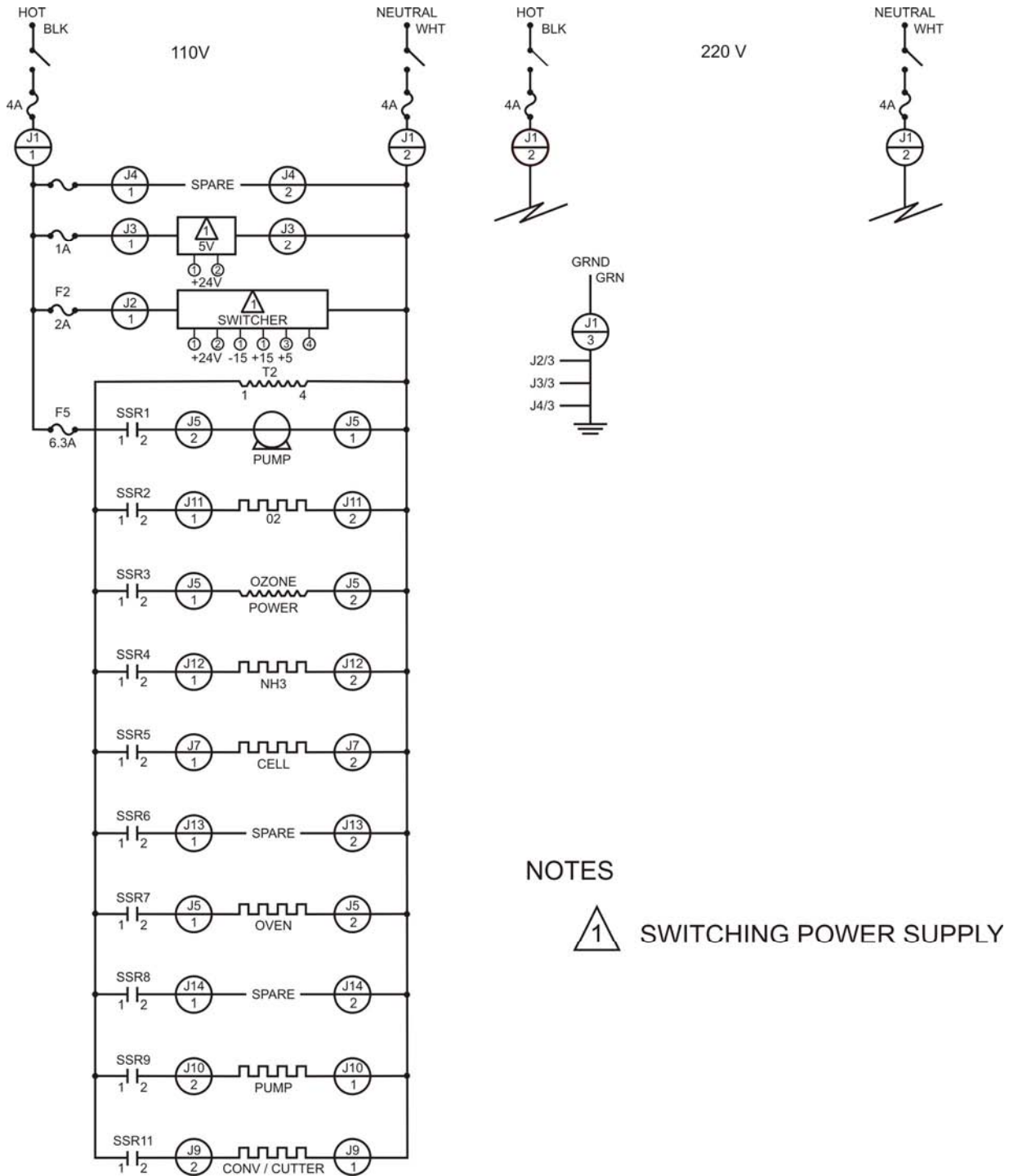

Figure 13-6 AC Power

## 13.5. Starting With Serial Number U06081

### 1.0 INTRODUCTION

The Model 600 HFID Series Instruments starting with Serial Number U06081 have several new Hardware and Software features.

The Hardware includes the use of a new memory system, isolation of the analog output signals and 15 relays that are used to buffer the many new digital output signals that are now available

The available digital signals consist of a SERVICE group, to externally monitor a number of parameters that provide insight for preventative maintenance and diagnostics decisions. A second STATUS group, is provided to define the operation of the instrument such as Spanning, Zeroing, Calibrating and the current Range (1, 2, 3, 4, AUTO).

The Software includes modifications to existing functions, changes to the Measurement screen, additional Short-Cut Keys and several New Functions that are listed as follows:

- **MEASUREMENT**

<b>Over Range</b>	<b>888888</b>
<b>C1/C3</b>	<b>Removed</b>
<b>Zero</b>	<b>F5</b>
<b>Span</b>	<b>F6</b>
<b>Range Limits</b>	<b>F8</b>
<b>Span Values</b>	<b>F9</b>
<b>Outputs</b>	<b>F10</b>

Note: The operator can use these Short-Cut Keys or continue to use existing procedures.

- **NEW FUNCTIONS**

<b>Auto Startup</b>	<b>F5, F7, F7</b>
<b>ALARMS</b>	<b>F5, F7, (Use F6 to toggle ON/OFF)</b>
<b>Offsets&amp; Gains</b>	<b>F4, F3, F5</b>
<b>D/A Calibration</b>	<b>F5, F7, F8</b>
<b>Cal Analog Outputs</b>	<b>F5, F8, (Use F8 to toggle ON/OFF)</b>
<b>Ignite ON Power Up</b>	<b>F5, F8, (Use F9 to toggle ON/OFF)</b>
<b>Save Data Archiving Time</b>	<b>F5, F7, F1, F5 (Use ENTER to change recording time)</b>
<b>User Digital Outputs</b>	<b>F5, F9</b>
- **Modifications**

<b>Saved/Not good</b>	<b>F4, F2, F1 or F2 (To flow Zero or Span Gas)</b>
<b>Re-Set Calibration Values</b>	<b>F4, F5</b>

### 2.0 OPERATION OF MEASUREMENT KEYS



Note: The ← &→ Keys continue to be used to view a complete list of menu items.

### 2.1 Zero: Select the required range then press **F5**.

Note: For instruments with an internal Zero Solenoid select Calibration By Valves. (**F5, F2, F4**)

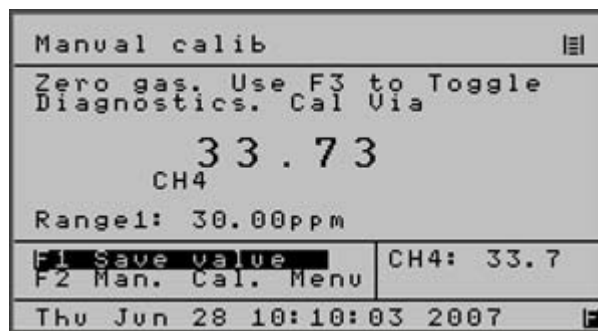

Zero Gas will be enabled and the observed results can be use to evaluate instrument performance.

Press **F3** to toggle to the Diagnostic screen for additional information

Press **F1** to save the value and complete a ZERO calibration for this channel and range

Press **MAIN, F1** to return to the MEASUREMENT screen to select other channels and ranges and repeat the process.

### 2.2 Span: Select the required range then press **F6**.

Note: For instruments with an internal Span Solenoid select Calibration By Valves. (**F5, F2, F4**)

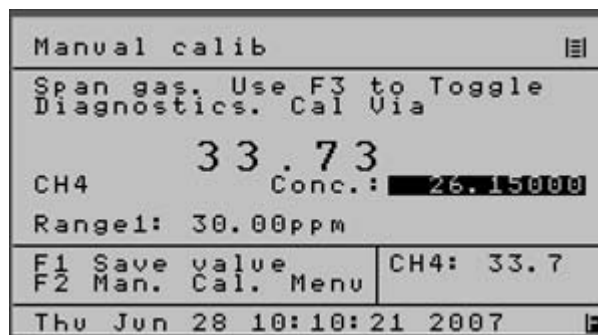

Span Gas will be enabled and the observed results can be use to evaluate instrument performance.

Press **F3** to toggle to the Diagnostic screen for additional information

Press **F1** to save the new value and complete the SPAN calibration for this Range.

Note: The span gas value used for this range is highlighted and can be changed if necessary. Use the Enter key and the numeric keys as required

### 2.3 Range Limits: (F8);

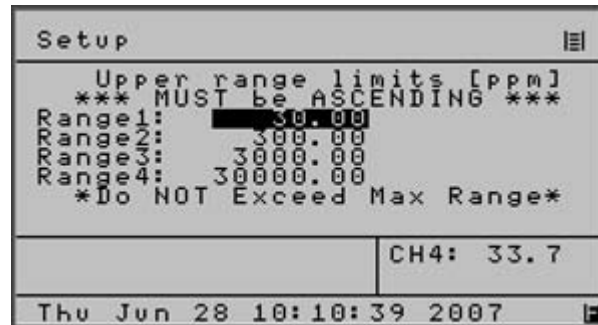

The analyzer is factory configured with 4 Physical Ranges of 30, 300, 3,000,30,000 PPM

The operator can change the number of ranges and select a more convenient full scale concentration if required.

Note: Do not exceed the maximum range of 30,000 PPM and always use ascending order as shown.

#### Example

- For a single range instrument, set Range 1 to the desired value and all others to zero
- For a two range instruments, set Range 1 to the lowest value, Range 2 to the highest value and the others to zero.

### 2.4 Span Values: F9

Setup	
Span gas conc. range limits	
Range1:	26.150 30.00
Range2:	261.500 300.00
Range3:	2615.000 3000.00
Range4:	26145.000 30000.00
CH4: 33.7	
Thu Jun 28 10:11:03 2007	

Use to define the concentration of the span gas that will be used to calibrate each range.

Note that the span gas value used for this range is highlighted and can be changed if necessary. Use the Enter key and the numeric keys as required.

## 2.5 Outputs: F10

assignment	
Output	Signal
1	Calibrate
2	THC
3	CH4
4	SamplePres
CH4: 26.1	
Mon May 07 09:41:59 2007	

Use the ↑ to select the desired Output

Use this screen to define the signals and their location that will be monitored by a remote reordering device.

## 3.0 NEW FUNCTIONS

### 3.1 Auto Start Up: (F5, F7, F7)

Auto Startup	
•Auto Startup	: Off
•Wait for [min]	: 1
•Calibrations	: 3
•Startrange	: 1
•Access Level	: 4
•Remote/Manual	: Manual
•CH4/THC-Mode	: THC
MAIN SAVE	THC: 10.6
BACK SAVE	
Thu May 03 12:06:23 2007	

All key analyzer parameters are stored in a secure memory location and retained when power is removed

In the event of an unexpected power failure it may be desirable to change some parameters until an operator can resume control.

This screen may be used to establish several desirable special instrument start-up parameters that define how the analyzer recovers from loss of AC power

When enabled this screen will define the following:

**Wait:** The time delay in minutes before any of these special changes will be finalized...

**Calibrations:** The number of attempts to complete a successful calibration as required in the operator defined Deviation Tables.  
If calibration is not successful the instrument will continue reporting results using the last completed calibration.  
The analyzer can be configured use the previous calibration by selecting zero Calibrations.

**Starting Range:** When all defined actions are completed the analyzer will return to the Measurement Screen and at the range specified.

**Access Level:** The final access level

**Remote/Manual:** The final operating MODE

**THC/CH<sub>4</sub> MODE:** The final measurement MODE.

### 3.2 Alarms On/Off: (F5, F7)

System setup		
F1	RealTime-Clock	>>
F2	TCP/IP settings	
F3	Output assignment	
F4	Output Range	
F5	status line on/off	
F6	Alarms on/off	Off
F7	Autostart	
F8	D/A calibration	
analyser Alarms		THC: 3371.3
ON / OFF		
CAI Tel. (800) 959 0959		

Use **F6** to toggle ON/OFF

The instrument has an extensive library of error messages that will aid in the identification of various anomalous events and are displayed at the bottom of the screen. These messages will assist in Diagnostics and indicating the need for preventative maintenance.

This screen provides an **option** to disable these messages during initial start-up or as may be desired for a particular application.

### 3.3 Offset & Gain: (F4, F3, F5)

Offset and Gain			
Zero/Span applied correction			
	Offset	Gain	
Range1:	0.00	1.00	
Range2:	0.03	1.00	
Range3:	0.00	1.00	
Range4:	0.00	1.00	
			THC: 12.9
Thu May 03 11:58:44 2007			

OUTPUT	OFFSET	GAIN
0-20 ma	0.000	0.927
4-20 ma		

This screen can be used to provide an additional means to display calibration deviations.

The **OFFSET** is the value stored during zero calibration.

The **GAIN** is the value stored during span gas calibration using the operator defined calibration gas.

An increasing or decreasing change to the OFFSET or GAIN when used in conjunction with “Deviations” will provide insight to both short and long term changes to system performance

### 3.4 Calibrate The Digital Outputs:

F5, F7, F8 D/A Calibration

F5, F7, F3 Output Assignment

- **Overview**

The 600 FID Series is designed to provide three analog outputs that can be configured as 0-10v, 4-20 ma, or 0-20 ma.

With this version the outputs can also be configured to include an additional 1.0 volt and 5.0 volt output and a **calibration** capability. The outputs can be calibrated to exactly match the results obtained on a PLC, Recorder, Data Logger or other remote recording device that may be connected to the analyzer.

The operator will first select the **OUTPUT ASSIGNMENT** screen and choose the output that is to be calibrated. All outputs of interest may be selected. When calibration is completed, the operator will return the outputs to their original assignment

The **D-A CALIBRATION** screen will be then be used to complete the calibration procedure.

This screen provides a section that is used to record the zero signal corrections (zero offset) and a second area to record the 100% signal corrections (Gain) for each of the four output signals that may be defined to develop a voltage or current signal..

Since this is a Digital to Analog conversion, the calibration will require the completion of a simple “trial and error” procedure. The operator will observe the results of a “zero or full scale (Gain) signal generated by the analyzer to the remote recording device and select a correction factor The operator will save this value and then observe the results on attached the remote recording device.

The process of selection and saving for “zero” and “span” will be repeated until a satisfactory calibration is achieved. For 0-1V, 0-5V, 0-10V and a 0-20 ma outputs the Offset and Gain values are independent and do not interact... With the 4-20 ma output, the “Offset (zero)” and “Gain (span)” values interact and may require a few more trials.

The following is a table of typical values

:

OUTPUT	OFFSET	GAIN
0-20 ma	0.000	0.927
4-20 ma	1.820	0.740
0-1 V	1.300	0.820
0-5 V	1.100	0.820
0-10 V	1.050	0.820

- **Procedure**

**3.4.1** From the Main Menu press **F5,F7,F3**,to obtain following screen:

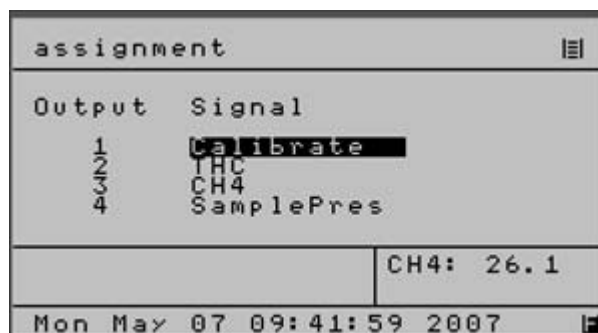

**F5, F7, F3**

**3.4.2.** Use the  $\uparrow$  to highlight the outputs that require calibration.

Note: In the above example only Output 1 will be calibrated  
Record the name of these signals, they will be restored.

**3.4.3.** Press enter to provide access to all the menu of signals that are available. (Real Time, THC, CH<sub>4</sub>, Calibration, Sample pressure, etc.)

**3.4.4.** Select Calibration and press **ENTER** to complete the selection

Note: Any or all of the four outputs can be selected for calibration  
This screen will not be used again until calibration has been completed.

**3.4.5.** Press **BACK** to return to the SYSTEM SETUP screen (**F5, F7** from the main menu)

**3.4.6.** Press **F8** to obtain the following screen:

output scaling		
Calibrate D/A	Outputs	
Output Offset	Gain	
1	1.8000	0.7000
2	1.8000	0.7000
3	1.8000	0.7000
4	1.8000	0.7000
**Set Output-F3-Calibrate**		
MAIN SAVE	F1:	THC% 10.9
BACK SAVE	F5:	100% FS
CAI Tel. (800) 959 0959		

F5, F7, F8

- 3.4.7. Use the  $\uparrow$  to select the desired output press **ENTER**
- 3.4.8. Press F1 to select a ZERO signal and observe the results on the remote device
- 3.4.9. Change the offset value press **BACK** to save the new value.
- 3.4.10. Press **F8** to return to the D-A Calibration screen and note the results on the remote device.
- 3.4.11. Repeat steps 8.0 thru 10.0 until a satisfactory ZERO calibration is achieved.
- 3.4.12. Complete steps 8.0 thru 10.0 for each of the remaining outputs that require calibration.
- 3.4.13. Press **F5** to produce a full scale (100%) signal
- 3.4.14. Use the arrow keys to position the cursor at the require GAIN value
- 3.4.15. Observe the results on the remote device and make a correction to the GAIN value for the output of interest. Press **BACK** to save this new value
- 3.4.16. Press **F8** to return to the D-A calibration screen
- 3.4.17. Observe the results on the remote device and repeat steps change the GAIN value by repeating steps14.0 thru 16.0 as needed for each output.
- 3.4.18. Return to the OUTPUT Assignment screen **F5, F7, F3** from the main menu and change the output signals from CALIBRATE to their original values as defined in step 3.4.2.

### 3.5 Cal Analog Output: (F5, F8,)



Measure setup		☰
F1	Lowpass filter Tc	
F2	Purge time	
F3	T + P compensation	
F4	Set dual-mode times	
F5	Cutter Coefficients	
F8	Cal Analog Out	On
F9	Ignite on power up	
set analog out during cal		THC: 3371.3
CAI Tel. (800) 959 0959		

Use **F8** to toggle on/off

This will provide improved versatility and control of the THC and CH4 output signals.

When THC or CH4 are assigned to specific outputs The CAL ANALOG output can be enabled by the operator and the MODE selected at the Measuring screen will be impressed at the selected output.

### 3.6 Ignite on Power up (F5, F8)

Measure setup		☰
F1	Lowpass filter Tc	
F2	Purge time	
F3	T + P compensation	
F4	Set dual-mode times	
F5	Cutter Coefficients	
F8	Cal Analog Out	
F9	ignite on power up	On
Ignite on power up		THC: -3.8
CAI Tel. (800) 959 0959		

Use **F9** to toggle ON/OFF

### 3.7 Save Data Archiving Time (F5, F7, F1, F5)

Setup	RTC	SEC	☰
F1	Set time		
F2	Set autocalibration time		
F3	Select calibration range		
F4	Autocalibration on/off		
F5	Save Data Archiving Time		
F10	Archive Time(secs)	10	
Archive Interval		CH4: 33.7	
0 = Off F5:SAVE			
Thu Jun 28 07:10:16 2007			

Use ENTER to change recording time

### 3.8 User Digital Outputs

- **Overview**

The 600 FID Series of instruments have 15 solid state, optically coupled, isolated relays that can be programmed by the operator to indicate the status of numerous digital conditions

The available digital signals consist of a SERVICE group, that can be used to externally monitor a number of conditions to aid in preventative maintenance and diagnostics.

A second STATUS group, is provided and is used to define the operation of the instrument such as Spanning, Zeroing, Calibrating and the current Range(1, 2, 3, 4, AUTO) etc.

The individual output signals can be operator selected and set to a **HOLD** or **CLEAR** mode.

In the **HOLD** mode an activated signal is retained until the operator returns to the **Digital Output Screen** and selects the appropriate output signal and performs a manual CLEAR.

In the **CLEAR** mode the signal will automatically change state when the microprocessor detects that the noted condition no longer exists.

The operator can select from the following the desired **SERVICE** or **STATUS** items that are to be digitally monitored.

- **SERVICE**

SIGNAL	Displayed Message	MIN	MAX	Definition
Flame	No Flame			
SampleP	Sample Pressure ,Check			
AirP	Air Pressure ,Check	1.5	2.5	Sample pressure
FuelP	Fuel Pressure ,Check	6	10	Air pressure
AirInjP	Air Inject Pressure ,Check	6	10	Fuel Pressure
FuelInjP	Fuel Inject Pressure ,Check	6	10	Air Inject Pressure
FilterT	Filter Temp ,Check	6	10	Fuel Inject Pressure
BurnerT	Burner Temp ,Check	180	200	Filter Temp
OvenT	Oven Temp ,Check	200	400	Burner Temp
CuttT	Cutter Temp ,Check	180	200	Oven temp
PumpT	Pump Temp ,Check	250	350	Cutter temp
SEV	EPC Coil Sample ,Check	180	200	Pump temp
AEV	EPC Coil Air ,Check	2	8	Sample EPC Coil
FEV	EPC Coil Fuel ,Check	2	8	Air EPC Coil
AIEV	EPC Coil Air Inject ,Check	2	8	Fuel EPC Coil
FIEV	EPC Coil Fuel Inject ,Check	2	8	Air Inject EPC Coil
OR	Range overflow	2	8	Fuel Inject EPC Coil
AO	ADC Range Overflow			
AU	ADC Range Underflow			
R1NC	Range 1 is not calibrated			
R2NC	Range 2 is not calibrated			
R3NC	Range 3 is not calibrated			
R4NC	Range 4 is not calibrated			
LoC				
HiC				
OFF				

NOTE: The MIN and MAX shown are typical factory values and are operator adjustable..  
The appropriate CHECK message is displayed if the signal is not within the MIN/MAX window.

- **STATUS**

General Alarm	GenAlarm
In Remote	InRem
Cal Alarm	CalAlarm
AutoRange	AutoR
Range 1	R1
Range 2	R2
Range 3	R3
Range 4	R4
In Calibrate	InCal
In Zero	Zero
In Span	Span
In Sample	Sample
In THC Mode	InTHC
In Overflow	InOflow

## TYPICAL RELAY

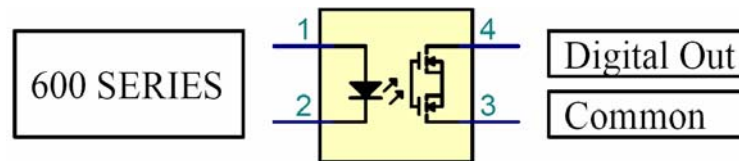

These contacts(3, 4) will drive continuously up to 500 MA using a customer voltage supply that does not to exceed 60 VDC.

- **Operation**

Use **F5**, **F9** to select the first eight outputs

Use the ↑ to select the desired output  
 Press ENTER and use ↓ to select desired item  
 NOTE the 600 FID can provide 35 digital output signals

User DO I		
1	Lame	
2	AirP	
3	FuelP	
4	FilterT	*Set Unused *
5	Off	*Channels Off*
6	Off	
7	Off	
8	Off	
F1 9 to 15 DO's & MAIN/BACK to SAVE		THCa-26.0d
Check Fuel Pressure		

Press **F1** to observe the remaining seven outputs  
 Program as desired per the above

User DO II		
1	Off	
2	Off	
3	Off	
4	Off	*Set Unused *
5	Off	*Channels Off*
6	Off	
7	Off	
F2 Hold / Clear		Hold
F1 1 to 8 DO's MAIN/BACK to SAVE		THC: -26.0
Check Air EPC Coil V		

#### 4.0 CHANGES TO EXISTING FUNCTIONS

#### 4.1 Saved or NOT GOOD

During Manual Calibration the following screens will be displayed to indicate the instruments response to the value of the zero or span gas using the amount that the operator defined in the deviation table.

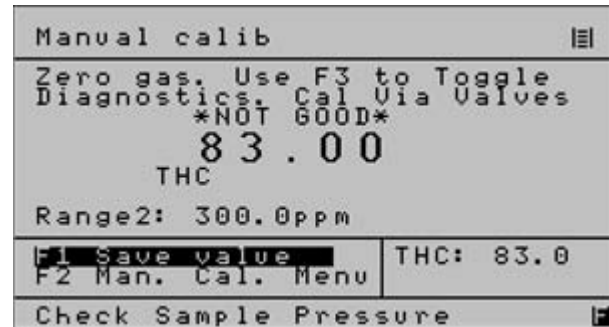
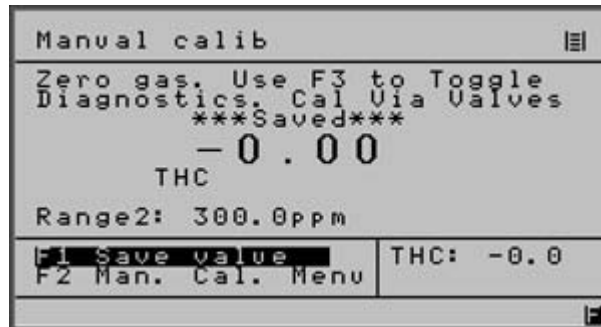

The above is shown using Zero Gas

From Measurement use: **F5 or F6**

From Main Menu use: **F4, F2, F1 or F2**

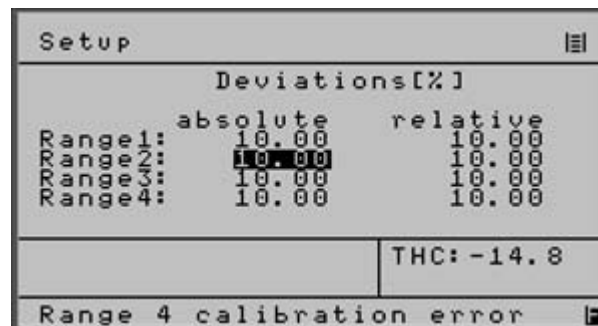

**F5, F2, F3**

Note :This screen is used by the operator to define the maximum acceptable limits of the Zero and Span gas for both Manual and Automatic Calibrating.

#### 4.2 Reset Calibration Values

When the re-set calibrations value function is used all recorded deviations will be set to zero

Def cal value	
Are you sure to reset calibration values to default values?	
F1	yes
F2	no
THC: -25.9	
Range 4 calibration error	

F4, F5

Span gas devs			
Span gas devs. verifying			
Range	measured values	deviations Uar	%FS
1	0.0	0.00	0.00
2	0.0	0.00	0.00
3	0.0	0.00	0.00
4	0.0	0.00	0.00
THC: 10.3			
Check Air EPC Coil V			

F4 F3, F4

(Used to observe Auto Cal Results)

Span gas devs		
Span gas deviations [%]:		
	abs	rel
Range1:	0.00	0.00
Range2:	0.00	0.00
Range3:	0.00	0.00
Range4:	0.00	0.00
THC: -26.0		
Check Air Inject Pressure		

F4, F3, F2

(Used to observe Manual Cal results)

The above are the new deviations after the operator elects to re-set the calibration values





TABLE OF CONTENTS

ADDENDUM

STARTING AFTER JUNE, 2007

<u>Section</u>	<u>Title</u>	<u>Page</u>
1.0.	Introduction -----	
2.0.	Operation of Measurement Keys -----	
	2.1. Over Range -----	
	2.2. Diagnostics -----	
	2.3. Zero -----	
	2.4. Span -----	
	2.5. Range Limits -----	
	2.6. Span Values -----	
	2.7. Outputs -----	
3.0	New Functions -----	
	3.1. Auto Start Up -----	
	3.2. Alarms On/Off -----	
	3.3. Offset & Gain -----	
	3.4. Calibrate The Analog Outputs -----	
	3.5. Save Data Archiving Time -----	
	TABLE A -----	
	3.6. User Digital Outputs -----	
	TABLE B -----	
	TABLE C -----	
	3.7. Cal Analog Output -----	
	3.8. Ignite On Power Up -----	
4.0.	Changes To Existing Functions -----	
	4.1. Saved or Outside Limits -----	
	4.2. Calibration Deviations -----	
	4.3. Flow Zero or Span Gas -----	
	4.4. Reset Calibration Values -----	
	TABLE D -----	

## Starting With Serial Number U06081

### 1.0 INTRODUCTION

The Model 600 HFID Series Instruments starting with Serial Number U06081 have several new Hardware and Software features.

The Hardware includes the use of a new memory system, isolation of the analog output signals and 15 relays that are used to buffer the many new digital output signals that are now available. **SEE TABLE D**

The available digital signals consist of a SERVICE group, to externally monitor a number of parameters that provide insight for preventative maintenance and diagnostics decisions.

A second STATUS group, is provided to define the operation of the instrument such as Spanning, Zeroing, Calibrating and the current Range (1, 2, 3, 4, AUTO).

The Software includes modifications to existing functions, changes to the Measurement screen, additional Short-Cut Keys and several New Functions that are listed as follows:

- **MEASUREMENT**

<b>Over Range</b>	<b>888888</b>
<b>C1/C3</b>	<b>Removed</b>
<b>Zero</b>	<b>F5</b>
<b>Span</b>	<b>F6</b>
<b>Range Limits</b>	<b>F8</b>
<b>Span Values</b>	<b>F9</b>
<b>Outputs</b>	<b>F10</b>

Note: The operator can use these Short-Cut Keys or continue to use existing procedures.

- **NEW FUNCTIONS**

<b>Auto Startup</b>	<b>F5, F7, F7</b>
<b>ALARMS</b>	<b>F5, F7, (Use F6 to toggle ON/OFF)</b>
<b>Offsets&amp; Gains</b>	<b>F4, F3, F5</b>
<b>D/A Calibration</b>	<b>F5, F7, F8</b>
<b>Cal Analog Outputs</b>	<b>F5, F8, (Use F8 to toggle ON/OFF)</b>
<b>Ignite ON Power Up</b>	<b>F5, F8, (Use F9 to toggle ON/OFF)</b>
<b>Save Data Archiving Time</b>	<b>F5, F7, F1, F5 (Use ENTER to change record time)</b>
<b>User Digital Outputs</b>	<b>F5, F9</b>

- **MODIFICATIONS**

<b>Saved/Not good</b>	<b>F4, F2, F1 or F2 (To flow Zero or Span Gas)</b>
<b>Re-Set Calibration Values</b>	<b>F4, F5</b>

**2.0 OPERATION OF MEASUREMENT KEYS:**

Note; The ← & → Keys continue to be used to view a complete list of menu items.

**2.1 Over Range 888888**

In the MEASUREMENT mode only, any value that exceeds the “range” by more than 10% will be displayed as 888888.

**2.2 Diagnostics:** Use **F3** to toggle between MEASUREMENT and DIAGNOSTIC

**2.3 Zero:** From the MEASUREMENT Screen select the required range then press **F5**.

Note: For instruments with an internal Zero Solenoid select Calibration by Valves. (**Main, F5, F2, F4**)

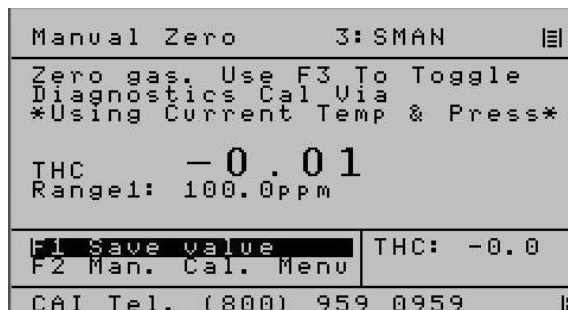
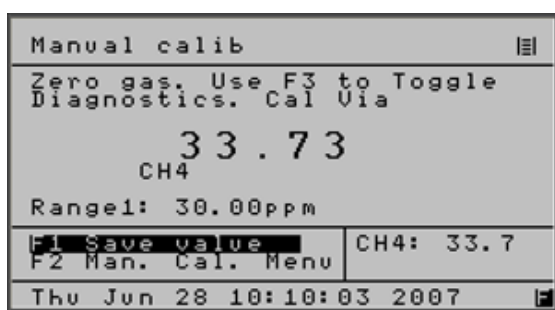

**2 Versions**

Zero Gas will be enabled and the observed results can be use to evaluate instrument performance.

Press **F3** to toggle to the Diagnostic screen for additional information

Press **F1** to save the value and complete a ZERO calibration for this channel and range

Press **MAIN, F1** to return to the MEASUREMENT screen to select other channels and ranges and repeat the process.

**2.4 Span:** From the MEASUREMENT Screen select the required range then press **F6**.  
 Note: For instruments with an internal Span Solenoid select Calibration by Valves. (**Main, F5, F2, F4**)

Manual calib	Manual Span 1: SARA
Span gas. Use F3 to Toggle Diagnostics. Cal Via	Span gas. Use F3 To Toggle Diagnostics Cal Via *Using Current Temp & Press*
CH4 33.73 Conc.: 26.15000	THC -0.00 Conc.: 90.00000
Range1: 30.00ppm	Range1: 100.0ppm
F1 Save value CH4: 33.7 F2 Man. Cal. Menu	F1 Save value THC: -0.0 F2 Man. Cal. Menu
Thu Jun 28 10:10:21 2007	CAI Tel. (800) 959 0959

2 Versions

Span Gas will be enabled and the observed results can be used to evaluate instrument performance.

Press **F3** to toggle to the Diagnostic screen for additional information

Press **F1** to save the new value and complete the SPAN calibration for this Range.

Note: The span gas value used for this range is highlighted and can be changed if necessary. Use the Enter key and the numeric keys as required

Press **MAIN, F1** to return to the MEASUREMENT screen to select other ranges and repeat the process or press **F2** to return to the Manual Calibration screen.

**2.5 Range Limits:** From the MEASUREMENT Screen select the required range then **F8**

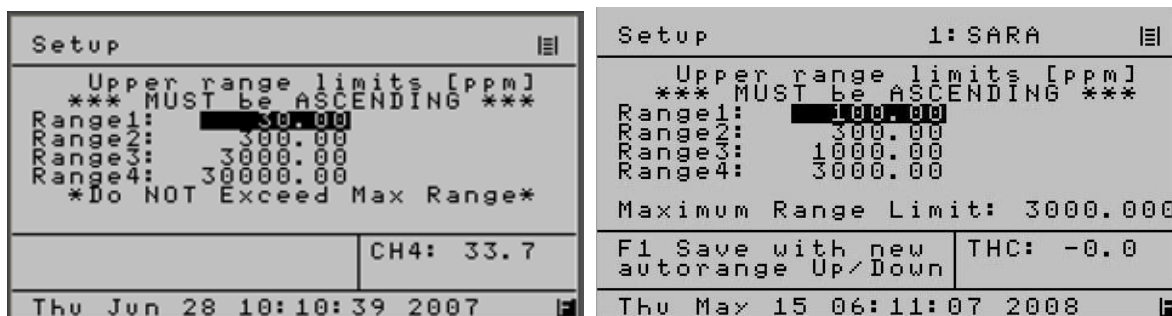

**2 Versions**

The analyzer is factory configured with 4 Physical Ranges of 30, 300, 3,000, 30,000 PPM

The operator can change the number of ranges and depending on which range you choose, your selection will change to that range number (ex: if you change your range to 300 in above your range number will change to Range 3) and select a more convenient full scale concentration if required.

Note: Do not exceed the maximum range set by the factory and always use ascending order as shown.

- Example a) For a single range instrument, set Range 1 to the desired value and all others to zero
- b) For a two range instruments, set Range 1 to the lowest value, Range 2 to the highest value and the others to zero.

**2.6 Span Values: F9 From the MEASUREMENT Screen**

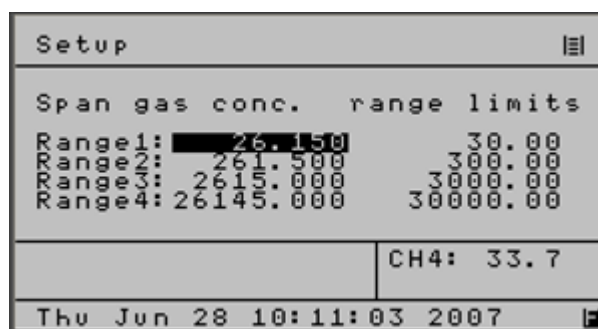

Use to define the concentration of the span gas that will be used to calibrate each range.

Note: The span gas value used for this range is highlighted and can be changed if necessary. Use the Enter key and the numeric keys as required.

2.7 Outputs: F10 From the MEASUREMENT Screen

assignment		1: SARA	☰
Output	Signal		
1	CH4		
2	NMHC		
3	THC		
4	Realtime		
		THC:	0.0
☒			

Use the ↑ to select the desired Output. Press Enter to select  
 Use the ↓ to select the desired Signal. Press Enter to select

Use this screen to define the signals and their location that will be monitored by a remote reordering device.

**SEE TABLE D**

### 3.0 NEW FUNCTIONS

#### 3.1 Auto Start Up: (Main, F5, F7, F7)

Auto Startup	
.Auto Startup	: Off
.Wait for [min]	: 1
.Calibrations	: 3
.Startrange	: 1
.Access Level	: 4
.Remote/Manual	: Manual
.CH4/THC-Mode	: THC
MAIN SAVE	THC: 10.6
BACK SAVE	
Thu May 03 12:06:23 2007	

All key analyzer parameters are stored in a secure memory location and retained when power is removed

In the event of an unexpected power failure it may be desirable to change some parameters until an operator can resume control.

This screen may be used to establish several desirable special instrument start-up parameters that define how the analyzer recovers from loss of AC power

When enabled this screen will define the following:

**Wait:** The time delay in minutes before any of these special changes will be finalized.

**Calibrations:** The number of attempts to complete a successful calibration as required in the operator defined Deviation Tables. If calibration is not successful the instrument will continue reporting results using the last completed calibration.  
The analyzer can be configured to use the previous calibration by selecting zero Calibrations.

**Starting Range:** When all defined actions are completed the analyzer will return to the Measurement Screen and at the range specified.

**Access Level:** The user level at Start Up.

**Remote/Manual:** Put the analyzer in either "Remote" or "Manual" at Start Up

**THC/CH<sub>4</sub> MODE:** Put the analyzer in THC or CH<sub>4</sub> or NMHC mode at Start Up.

### 3.2 Alarms On/Off: (Main, F5, F7)

All key analyzer parameters are stored in a secure memory location and retained when power is removed. In the event of an unexpected power failure it may be desirable to change some parameters until an operator can resume control.

This screen may be used to establish several desirable special instrument start-up parameters that define how the analyzer recovers from loss of AC power.

When enabled this screen will define the following:

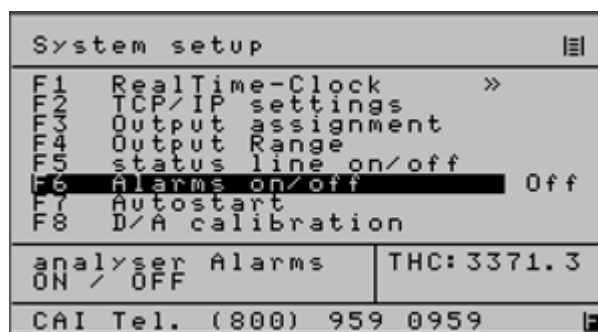

Use **F6** to toggle ON/OFF

The instrument has an extensive library of error messages that will aid in the identification of various anomalous events and are displayed at the bottom of the screen. These messages will assist in Diagnostics and indicating the need for preventative maintenance

This screen provides an **option** to disable these messages during initial start-up or as may be desired for a particular application.



### 3.3 Offset & Gain: (Main, F4, F3, F5)

Offset and Gain		
Zero/Span applied correction		
	Offset	Gain
Range1:	0.00	1.00
Range2:	0.03	1.00
Range3:	0.00	1.00
Range4:	0.00	1.00
		THC: 12.9
Thu May 03 11:58:44 2007		

This screen can be used to provide an additional means to display calibration deviations.

The OFFSET is the value stored during zero calibration.

The GAIN is the value stored during span gas calibration using the operator defined calibration gas.

An increasing or decreasing change to the OFFSET or GAIN when used in conjunction with "Deviations" will provide insight to both short and long term changes to system performance

Note: Reset calibration values will reset OFFSETS & GAINS to zero and 1 respectively

### 3.4 Calibrate the Analog Outputs: (Main, F5, F7, F8) D/A Calibration (Main, F5, F7, F3) Output Assignment

- **Overview**

The 600 FID Series is designed to provide three analog outputs that can be configured as 0-1 VDC, 0-5 VDC, 0-10 VDC, 4-20 mA, or 0-20 mA.

This screen (**Main, F5, F7, F8**) is used to select the scaling of the current (mA) or voltage (1, 5, 10) range that is required by a remote recording device. The outputs can be calibrated to exactly match the results obtained on a PLC, Recorder, Data Logger or other remote recording device that may be connected to the analyzer.

The operator will first select the **OUTPUT ASSIGNMENT** screen and choose the output that is to be calibrated. All outputs of interest may be selected. When calibration is completed, the operator will return the outputs to their original assignment

The **D-A CALIBRATION** screen will then be used to complete the calibration procedure.

```

output scaling  1: SARA
-----
Calibrate D/A Outputs
Output Offset   Gain      mA
-----
 1    1.8000    0.7000
 2    1.8000    0.7000
 3    1.8000    0.7000
 4    1.8000    0.7000
**Set Output-F3-Calibrate**
-----
MAIN / BACK SAVE  |  THC: -0.0
FS F1: 0%  F5: 100%
-----
Range 4 calibration error
    
```

This screen provides a section that is used to record the zero signal corrections (zero offset) and a second area to record the 100% signal corrections (Gain) for each of the four output signals that may be defined to develop a voltage or current signal.

Since this is a Digital to Analog conversion, the calibration will require the completion of a simple “trial and error” procedure. The operator will observe the results of a “zero or full scale (Gain) signal generated by the analyzer to the remote recording device and select a correction factor.

The process of selection and saving for “zero” and “span” will be repeated until a satisfactory calibration is achieved. For 0-1V, 0-5V, 0-10V and a 0-20 ma outputs the Offset and Gain values are independent and do not interact... With the 4-20 ma output, the “Offset (zero)” and “Gain (span)” values interact and may require a few more trials.

The following is a table of typical values

:

<b>OUTPUT</b>	<b>OFFSET</b>	<b>GAIN</b>
0-20 ma	0.000	0.927
4-20 ma	1.820	0.740
0-1 V	1.300	0.820
0-5 V	1.100	0.820
0-10 V	1.050	0.820

- Procedure

3.4.1 From the Main Menu press **F5,F7,F3**,to obtain following screen:

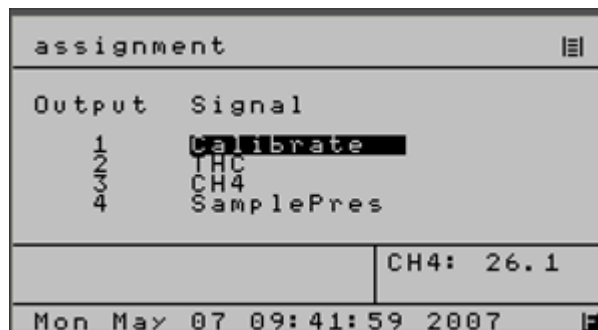

F5, F7, F3

3.4.2. Use the ↑ to highlight the outputs that require calibration.

Note; In the above example only Output 1 will be calibrated  
Record the name of these signals, they will be restored.

3.4.3. Press enter to provide access to all the menu of signals that are available.  
(Real Time, THC, CH<sub>4</sub>, Calibration, Sample Pressure, etc.)

3.4.4. Select Calibration and press **ENTER** to complete the selection

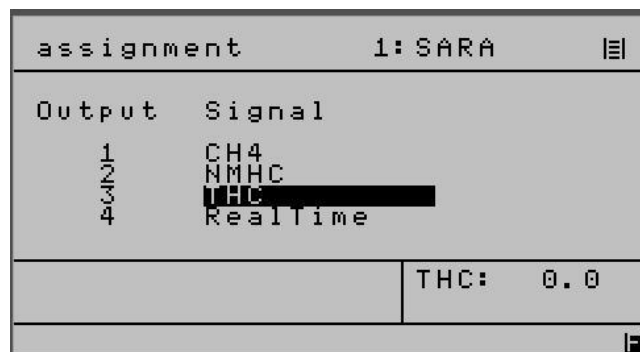

Note: Any or all of the four outputs can be selected for calibration  
This screen will not be used again until calibration has been completed.

3.4.5. Press **BACK** to return to the SYSTEM SETUP screen (**Main, F5, F7**)

3.4.6. Press **F8** to obtain the following screen:

output scaling		
Calibrate D/A Outputs		
Output	Offset	Gain
1	1.8000	0.7000
2	1.8000	0.7000
3	1.8000	0.7000
4	1.8000	0.7000
**Set Output-F3-Calibrate**		
MAIN SAVE	F1:	THC% 10.9
BACK SAVE	F5:	100% FS
CAI Tel. (800) 959 0959		

**Main, F5, F7, F8**

3.4.7. Use the ↑ to select the desired output and press **ENTER**

3.4.8. Press **F1** to select a ZERO signal and observe the results on the remote device

3.4.9. Change the offset value press **BACK** to save the new value.

3.4.10. Press **F8** to return to the D-A Calibration screen and note the results on the remote device.

3.4.11. Repeat steps 3.4.8 thru 3.4.10 until a satisfactory ZERO calibration is achieved.

3.4.12. Complete steps 3.4.8 thru 3.4.10 for each of the remaining outputs that require calibration.

3.4.13. Press **F5** to produce a full scale (100%) signal

3.4.14. Use the arrow keys to position the cursor at the require GAIN value

3.4.15. Observe the results on the remote device and make a correction to the GAIN value for the output of interest. Press **BACK** to save this new value

3.4.16. Press **F8** to return to the D-A calibration screen

3.4.17. Observe the results on the remote device and repeat steps change the GAIN value by repeating steps 3.4.14 thru 3.4.16 as needed for each output.

3.4.18. Return to the OUTPUT Assignment screen **F5, F7, F3** from the main menu and change the output signals from CALIBRATE to their original values as defined in step 3.4.2.

### 3.5 Save Data Archiving Time (Main, F5, F7, F1, F5)

Archive Time is the Time in seconds between each set of data points. If “zero” no data is stored in the SEC data files. The SEC data files are in .CSV format for direct import into Excel. CAI can provide the tools necessary to download these files.

Setup	RTC	SEC	
F1	Set time		
F2	Set autocalibration time		
F3	Select calibration range		
F4	Autocalibration on/off		
F5	Save Data Archiving Time		
	Archive Time(secs)		10
F10	Show time		
Archive Interval		CH4:	33.7
0 = Off F5:SAVE			
Thu Jun 28 07:10:16 2007			

Use ENTER to change recording time

**SEE TABLE A**

**TABLE A****600 SERIES HFID DATA ARCHIVE FILES**

**Time,  
Date,  
Month,  
Year,  
Error Index,  
TimeStamp,  
CH4 Conc,  
NMHC Conc,  
THC Conc,  
Concentration,  
Detector Volts,  
Range,  
Auto / Manual,  
Span Gas,  
Offset,  
Gain,  
Sample Pressure,  
Sample Flow,  
Sample EPC Volts,  
Air Pressure,  
Air Flow,  
Air EPC Volts,  
Fuel Pressure,  
Fuel Flow,  
Fuel EPC Volts,  
AirInj Pressure,  
AirInj Flow,  
AirInj EPC Volts,  
FuelInj Pressure,  
FuelInj Flow,  
FuelInj EPC Volts,  
Filter Temp,  
Burner Temp,  
Oven Temp,  
Pump Temp,  
Cutter Temp,  
Meas Mode,  
Local / Remote,  
Cutter,  
Cutter Efficiency,  
CH4 Relative Response,  
CH4 Zero Difference**

### 3.6 User Digital Outputs

- **Overview**

The 600 FID Series of instruments have 15 solid state, optically coupled, isolated relays that can be programmed by the operator to indicate the status of numerous digital conditions

The available digital signals consist of a SERVICE group that can be used to externally monitor a number of conditions to aid in preventative maintenance and diagnostics. **SEE TABLE B & D**

A second STATUS group, is provided and is used to define the operation of the instrument such as Spanning, Zeroing, Calibrating and the current Range (1, 2, 3, 4, AUTO) etc. **SEE TABLE C & D**

The individual output signals can be operator selected and set to a **HOLD** or **CLEAR** mode.

In the **HOLD** mode an activated signal is retained until the operator returns to the **Digital Output Screen** and selects the appropriate output signal and performs a manual CLEAR.

User DO I	2: SMGA	☰
1	R1	
2	R2	
3	AirP	
4	Off	*****
5	Off	*Set Unused *
6	Off	*Channels Off*
7	Off	*****
F2	Hold / Clear	
F1 8 to 15 DO's		THC: 0.0
MAIN/BACK to SAVE		

In the **CLEAR** mode the signal will automatically change state when the microprocessor detects that the noted condition no longer exists.

User DO II	1: SARA	☰
8	Off	
9	Off	
10	Off	
11	Off	*****
12	Off	*Set Unused *
13	Off	*Channels Off*
14	Off	*****
15	Off	
F1 1 to 7 DO's		THC: 0.0
MAIN/BACK to SAVE		

The operator can select from the following the desired **SERVICE** or **STATUS** items that are to be digitally monitored.

**TABLE B**

<b>Index</b>	<b>Service Group</b>	<b>User DO Screen Display</b>
0		
1	No Flame	Flame
2	Sample Pressure Failure	SampleP
3	Air Pressure Failure	AirP
4	Fuel Pressure Failure	FuelP
5	Air Inject Pressure Failure	AirInjP
6	Fuel Inject Pressure Failure	FuelInjP
7	Filter Temp Failure	FilterT
8	Burner Temp Failure	BurnerT
9	Oven Temp Failure	OvenT
10	Cutter Temp Failure	CuttT
11	Pump Temp Failure	PumpT
12	EPC Coil Sample Failure	SEV
13	EPC Coil Air Failure	AEV
14	EPC Coil Fuel Failure	FEV
15	EPC Coil Air Inject Failure	AIEV
16	EPC Coil Fuel Inject Failure	FIEV
17	Range overflow	OR
18	ADC Range Overflow	AO
19	ADC Range Underflow	AU
20	Range 1 is not calibrated	R1NC
21	Range 2 is not calibrated	R2NC
22	Range 3 is not calibrated	R3NC
23	Range 4 is not calibrated	R4NC
24	Low concentration Warning	LoC
25	High concentration Warning	HiC
26	dummy text for RTC	Off
27	<b>General Alarm</b>	<b>GenAlarm</b>
29	<b>Cal Alarm</b>	<b>CalAlarm</b>



**TABLE C**

Index	Status Group	User DO Screen Display
28	In Remote	InRem
30	AutoRange	AutoR
31	Range 1	R1
32	Range 2	R2
33	Range 3	R3
34	Range 4	R4
35	In Calibrate	InCal
36	In Zero	Zero
37	In Span	Span
38	In Sample	Sample
39	In THC Mode	InTHC
40	In CH4 Mode	InCH4
41	In Overflow	InOflow
42	In Purge	InPurge

TYPICAL RELAY

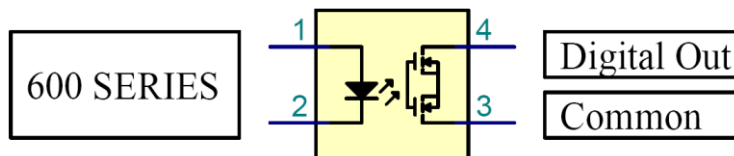

These contacts(3, 4) will drive continuously up to 500 MA using a customer voltage supply that does not to exceed 60 VDC.

- **Operation**

Use **Main, F5, F9** to select the first eight outputs  
 Use the  $\uparrow$  to select the desired output  
 Press ENTER and use  $\uparrow$  to select desired item  
 Press ENTER to save selection.

NOTE: The 600 FID has 15 user selectable isolated digital outputs from the list of 42 in **TABLE B & C**

```

User DO I          2: SMGA
-----
1  R1
2  R2
3  AirP *****
4  Off  *Set Unused *
5  Off  *Channels Off*
6  Off  *****
7  Off
F2 Hold / Clear
-----
F1 8 to 15 DO's   THC:  0.0
MAIN/BACK to SAVE
    
```

Press **F1** to observe the remaining seven outputs  
 Program as desired per the above

```

User DO II         1: SARA
-----
8  Off
9  Off
10 Off
11 Off *****
12 Off *Set Unused *
13 Off *Channels Off*
14 Off *****
15 Off
-----
F1 1 to 7 DO's   THC:  0.0
MAIN/BACK to SAVE
    
```

3.7 Cal Analog Output: (Main, F5, F8,)

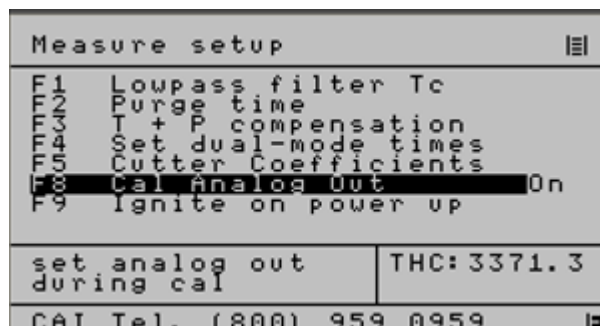

Use **F8** to toggle on/off

This will provide improved versatility and control of the THC and CH4 output signals. When THC or CH4 are assigned to specific outputs The CAL ANALOG output can be enabled by the operator and the MODE selected at the Measuring screen will be impressed at the selected output.

3.8 Ignite on Power Up: (Main, F5, F8)

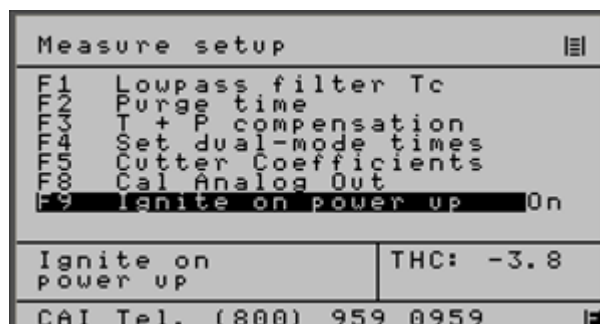

Use **F9** to toggle ON/OFF

## 4.0 CHANGES TO EXISTING FUNCTIONS

### 4.1 Saved or Outside Limits

During Manual Calibration the following screens will be displayed to indicate the instruments response to the value of the zero or span gas using the amount that the operator defined in the deviation table.

```

Manual Zero      1: SARA      |
-----
Zero gas. Use F3 To Toggle
Diagnostics Cal Via
*Using Current Temp & Press*
***Saved Current***
THC              0.01
Range1: 100.0ppm
-----
F1 Save value      | THC: 0.0
F2 Man. Cal. Menu  |
-----
CAI Tel. (800) 959 0959 |
  
```

```

Manual Span      2: SEGA      |
-----
Span gas. Use F3 To Toggle
Diagnostics Cal Via
*Using Current Temp & Press*
Outside Deviation Limits
THC              -0.04
Range1: 100.0ppm  Conc.: 90.00000
-----
F1 Save value      | THC: -0.0
F2 Man. Cal. Menu  |
-----
Thu May 15 06:06:48 2008 |
  
```

The above is shown using Zero Gas

From Measurement use: **F5 “zero” or F6 “span”**  
 From Main Menu use: **F4, F2, F1”zero” or F2 “span”**

4.2. Calibration Deviations:

MAIN, F5, F2, F2 Deviations, F3 Measuring Deviations.

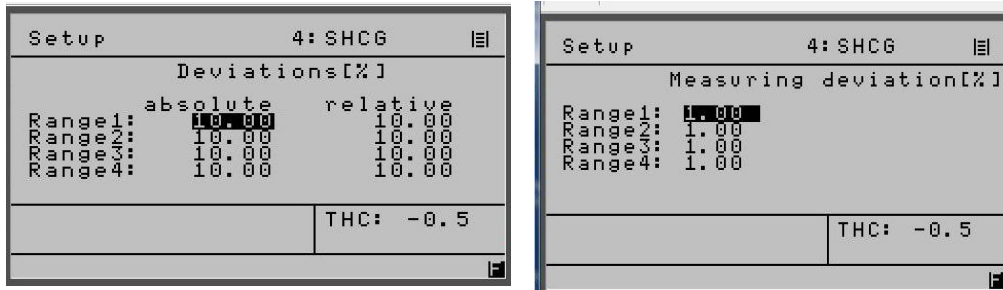

Note: These screens are used by the operator to define the maximum acceptable limits of the Zero and Span gas for both Manual and Automatic Calibrating.

4.3 Flow Zero or Span Gas

Some analyzers have the above and the ability to flow Zero and Span Gas.

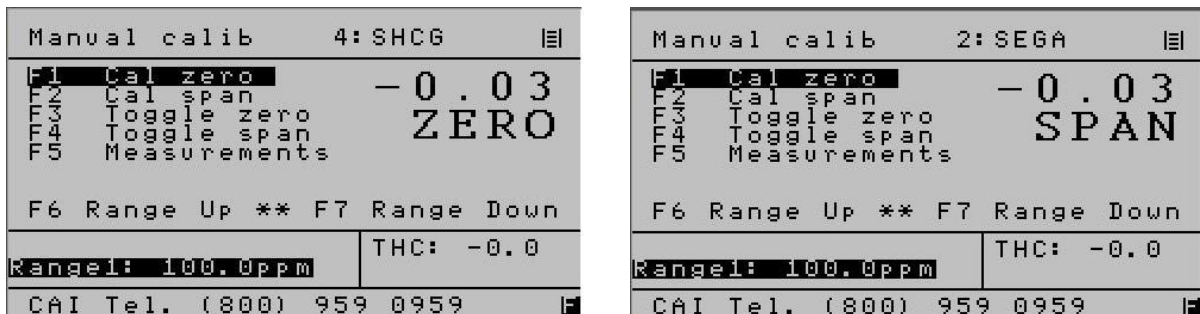

The above is shown using Zero/SPAN Gas

From Cal Screen use: **F2 or Main or Back**  
 From Main Menu use: **F4, F2**

#### 4.4 Reset Calibration Values

When the re-set calibrations value function is used all recorded deviations will be set to zero

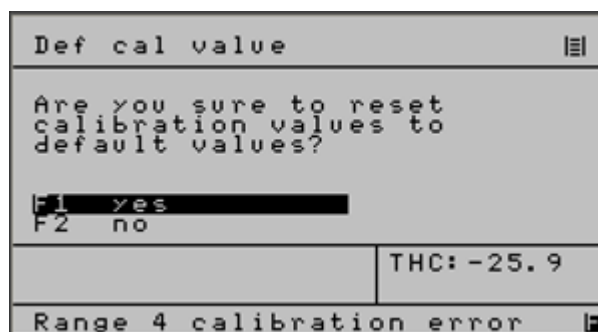

Main, F4, F5

Span gas devs			
Span gas devs. verifying			
Range	measured values	deviations	
		Uar	%FS
1 :	0.0	0.00	0.00
2 :	0.0	0.00	0.00
3 :	0.0	0.00	0.00
4 :	0.0	0.00	0.00
			THC: 10.3
Check Air EPC Coil V			

Main, F4 F3, F4

(Used to observe Auto Cal Results)

Span gas devs		
Span gas deviations [%]:		
	abs	rel
Range1:	0.00	0.00
Range2:	0.00	0.00
Range3:	0.00	0.00
Range4:	0.00	0.00
		THC: -26.0
Check Air Inject Pressure		

Main, F4, F3, F2

(Used to observe Manual Cal results)

The above are the new deviations after the operator elects to re-set the calibration values.

**TABLE D****600 SERIES FID/HFID IO CHART****28 PIN MAIN CONNECTOR ASSIGNMENTS**

AO = Analog Output, OC= Open Collector, SV = Solenoid Valve TTL = Transistor Logic

OPTO I/O	Signal Type	600 FID/HFID		Levels
		Analog		
<b>ALG 1</b>		pin #		
COM	A Output	1	<b>GND (Isolated analog)</b>	<b>Isolated AI</b>
0	A Output	2	<b>User Defined AO-1</b>	1v,5v,10v,mA
1	A Output	3	<b>User Defined AO-2</b>	1v,5v,10v,mA
2	A Output	4	<b>User Defined AO-3</b>	1v,5v,10v,mA
3	A Output	5	<b>User Defined AO-4</b>	1v,5v,10v,mA
<b>DIG 1</b>		<b>Digital</b>		
COM	D Output	6	GND (Digital)	
0	D Output	7	Sense Auto Range	<b>TTL-low true</b>
1	D Output	8	Sense Range 1	<b>TTL-low true</b>
2	D Output	9	Sense Range 2	<b>TTL-low true</b>
3	D Output	10	Sense Range 3	<b>TTL-low true</b>
4	D Output	11	Sense Range 4	<b>TTL-low true</b>
5	D Input	12	Set Auto Range	
6	D Input	13	Control Range 1	
7	D Input	14	Control Range 2	
8	D Input	15	Control Range 3	
9	D Input	16	Control Range 4	
10	D Input	17	Auto Cal	
11	D Input	18	Calibrate	
12	D Input	19	Zero	
13	D Input	20	Span	
14	D Input	21	Sample	
15	SPARE			
<b>DIG 2</b>				
0	D Output	22	Zero Gas Flow	<b>OC (24vdc if internal SV)</b>
1	D Output	23	Span Gas Flow	<b>OC (24vdc if internal SV)</b>
2	D Output	24	Sample Gas Flow	<b>OC (24vdc if internal SV)</b>
3	D Output	25	Local/Remote	<b>TTL-low true</b>
4	D Output	26	Read Cal Mode	<b>TTL-low true</b>
5	D Output	27	Reserved	
6	D Output	28	Reserved	

**TABLE D (CONT)****600 SERIES FID/HFID IO CHART****28 PIN AUXILLARY CONNECTOR ASSIGNMENTS**

OPTO I/O	Signal Type	FID/HFID		LEVELS
		Analog		
<b>ALG 1</b>	Spare	pin #		
COM	A Input	1	GND (analog)	
4	A Input	2	External Analog 1	0-10V
5	A Input	3	External Analog 2	0-10V
6	A Output	4	<b>GND (Isolated analog)</b>	
7	D Output	5	<b>Relay RTN 1</b>	
<b>DIG 3</b>	<b>Alarms</b>	<b>Digital</b>		<b>9,10,11,12 use RTN 1</b> <b>Alarms go OPEN when present</b> <b>Status go CLOSED when active</b>
COM	D Output	6	<b>Relay RTN 2</b>	<b>13,14,15,16 use RTN 2</b> <b>17,17,19,20 use RTN 3</b> <b>21,27,28 use RTN 4</b>
0	D Output	7	<b>Relay RTN 3</b>	
1	D Output	8	<b>Relay RTN 4</b>	
2	D Output	9	<b>User Defined NO Relay 1</b>	
3	D Output	10	<b>User Defined NO Relay 2</b>	
4	D Output	11	<b>User Defined NO Relay 3</b>	
5	D Output	12	<b>User Defined NO Relay 4</b>	
6	D Output	13	<b>User Defined NO Relay 5</b>	
7	D Output	14	<b>User Defined NO Relay 6</b>	
8	D Output	15	<b>User Defined NO Relay 7</b>	
9	D Output	16	<b>User Defined NO Relay 8</b>	
10	D Output	17	<b>User Defined NO Relay 9</b>	
11	D Output	18	<b>User Defined NO Relay 10</b>	
12	D Output	19	<b>User Defined NO Relay 11</b>	
13	D Output	20	<b>User Defined NO Relay 12</b>	
14	D Output	21	<b>User Defined NO Relay 13</b>	
15	D Output	22	<b>Reserved Do Not Connect</b>	
<b>DIG 2</b>				
7	D Input	23	Start Ignition	
8	D Input	24	Set Overflow	
9	D Input	25	Set THC Mode	
10	D Input	26	<b>Set Remote</b>	
11	D Output	27	<b>User Defined NO Relay 14</b>	
12	D Output	28	<b>User Defined NO Relay 15</b>	